

**Ledaks<sup>®</sup>**

**LED AYDINLATMA PROFİLLERİ - AKSESUARLARI**

**2022**

- \* LED BAR - IŞIK BANDI ALM. PRF VE AKSESUARLARI sf ; 1-16 aralığı
- \* Led bar-Light band alm. profile and accessories pg; 1-16
- \* YENİ İÇ MEKAN SAIVA ALTI - ÜSTÜ PLASTİK PRF. VE AKSESUARLARI sf ; 6
- \* New Indoor - Outdoor Plastic Profiles and Accessories pg; 6
- \* DOKUNMATİK - HAREKET SENSÖRLERİ sf ; 13
- \* Touch - Motion Switches pg; 13
- \* İÇ MEKAN LED BAR-IŞIK BANDI ALM. PRF. VE AKSESUARLARI sf ; 16-38 aralığı
- \* Indoor Led Band-Light Aluminium Profiles and Accessories pg; 16-38
- \* İÇ MEKAN AVİZE PROFİL VE AKSESUARLARI sf ; 23-26 aralığı
- \* Indoor Chandelier Profiles and Accessories pg; 23-26
- \* İÇ - DIŞ MEKAN AYDINLATMA ALM. PRF. VE AKSESUARLARI sf ; 39-41 aralığı
- \* Indoor - Outdoor Lighting Aluminium Profiles and Accessories pg; 39-41
- \* İÇ - DIŞ MEKAN ETANJ ALM. PRF. VE AKSESUARLARI sf ; 41-46 aralığı
- \* Indoor - Outdoor Etange Aluminium Profiles and Accessories pg; 41-46
- \* İÇ MEKAN LİNEER - SIVA ÜSTÜ ALM. PRF. VE AKSESUARLARI sf ; 47-50, 58-68 aralığı
- \* Indoor Lineer - Over Plaster Aluminium Profiles and Accessories pg; 47-50, 58-68
- \* İÇ MEKAN SIVA ALTI - ANKASTRE ALM. PRF. VE AKSESUARLARI sf ; 51-57 aralığı
- \* Indoor Lineer - Under Plaster - Recessed Aluminium Profiles and Accessories pg; 51-57
- \* DIŞ MEKAN WALLWASHER ALM. PROFİL VE AKSESUARLARI sf ; 69-78 aralığı
- \* Outdoor Wall Washer Aluminium Profiles and Accessories pg; 69-78
- \* DIŞ MEKAN SOKAK ARMATÜR KASALARI sf ; 79,80
- \* Outdoor Street Lighting Cases pg; 79,80
- \* DIŞ MEKAN PROJEKTÖR KASA ALM. PROFİLİ VE AKSESUARLARI sf ; 81-89 aralığı
- \* Outdoor Projector - Flood Light Cases of Aluminium Profiles and Accessories pg; 81-89
- \* REKLAM PROFİLLERİ sf ; 30,90
- \* Advertisement Profiles pg; 30,90
- \* KUTU - SÜRÜCÜ - SİGMA - BORU ALM. PROFİLLERİ sf ; 91,92
- \* Box - Driver - Sigma - Tube Aluminium Profiles pg; 91,92
- \* DAİRESEL ALM. SOĞUTUCU PROFİLLER sf ; 93-104 aralığı
- \* Aluminium Round Heatsink Profiles pg; 93-104
- \* DÜZ - KOMPONENT ALM. SOĞUTUCU PROFİLLERİ sf ; 105-119 aralığı
- \* Aluminium Flat - Component Heatsink Profiles pg; 105-119



İSTEĞE ÖZEL TASARIM - ÜRETİM YAPILIR  
Custom designs can be produced according to requirements

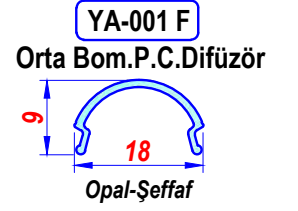
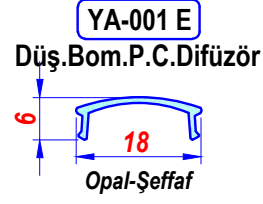
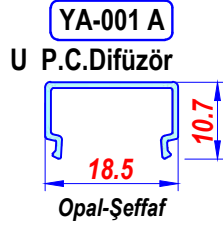
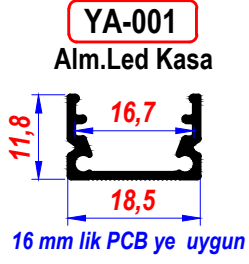

YA-001 A

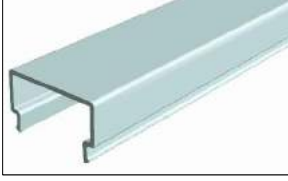

YA-001 C



YA-001 E

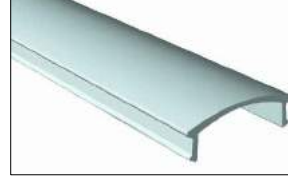

YA-001 F



PC.DİFÜZÖR-ALM.PRF. 610 cm

PC.DİFÜZÖR, OPAL-ŞEFFAF

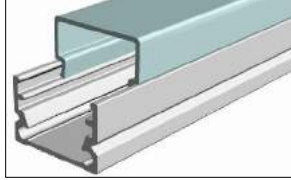

YA-001

YA-001 A

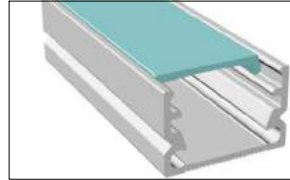

YA-001

YA-001 C

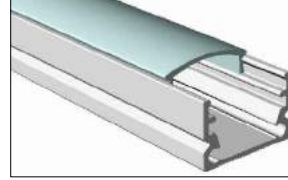

YA-001

YA-001 E

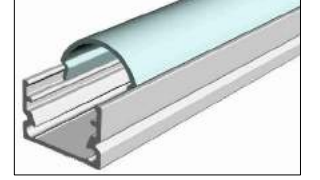

YA-001

YA-001 F

**YA-001 A1**

Yüksek Köşeli Pls.Tapa



YA-001 A PC ye uygun

**YA-001 F 3**

Orta Bombeli Pls. tapa



YA-001 F PC ye uygun

**YA-001 E 1**

Düşük Bom.Pls. Tapa



YA-001 E ye uygun

**YA-001 C 1**

Pls. Kenar Tapa

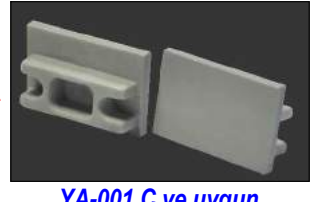

YA-001 C ye uygun

KULAKLI-DÜĞMELİ

RENK, BEYAZ

RENK, A.GRİ

**YA-001 A2**

Yüksek Köşeli Pls.Tapa



YA-001 A PC ye uygun

**YA-001 F 2**

Orta Bombeli Pls. Tapa



YA-001 F PC ye uygun

**YA-001 F 1**

Orta Bombeli Pls. Tapa



RENK ; Açık Gri

**YA-001 S**

ON-OFF Switch



YA-001 A1 YA-001 F3 de kullanılır

RENK Siyah-Beyaz

YA 001 A1-YA 001 A2 - YA 001 S UYGULAMASI

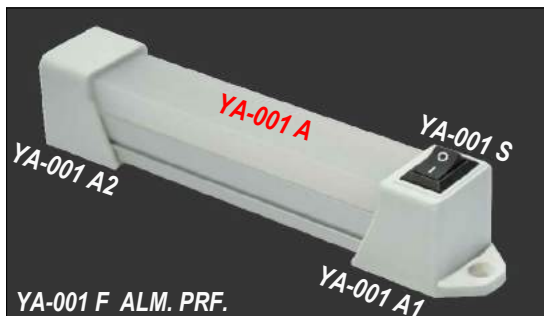

YA 001 F2-YA 001 F3 - YA 001 S UYGULAMASI



İSTENİLEN ÖLÇÜLERDE KESİM YAPILIR

All cutting dimensions can be done according to requirements

YA-001 A3

Yük. Köş. Alm.Tapa



YA 001 A Uygun

YA-001 D

Alm.Duvar Bağlt. Aprt.

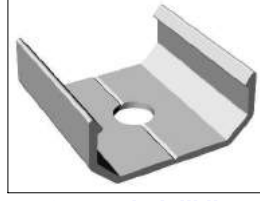

2 cm tek delikli

YA-001 D 1

Duvar Bağlt. Aprt.

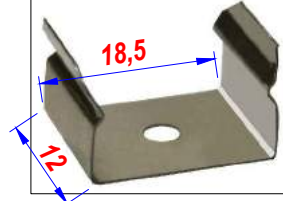

Paslanmaz Çelik

YA-001 D 2

Duvar Bağlt. Aprt.



Paslanmaz Çelik

90° Köşeler için

YA-001, YA001 A PC.DİFÜZÖR UYGULAMASI

YA-001 A PC.CAM

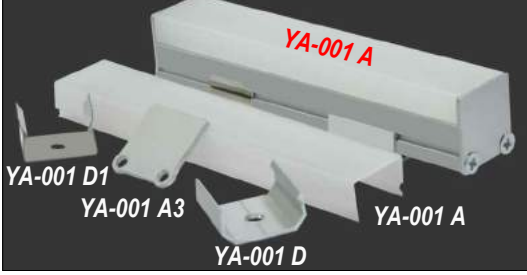

YA-001, YA001 C PC.DİFÜZÖR UYGULAMASI

YA-001 C PC.CAM



YA-001, YA001 E PC.DİFÜZÖR UYGULAMASI

YA-001 E PC.CAM



YA-001, YA001 F PC.DİFÜZÖR UYGULAMASI

YA-001 F PC.CAM

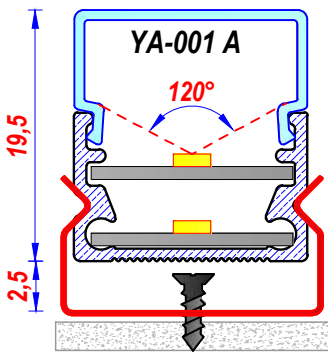

ZEMİN-DUVAR-MOBİLYA  
YA-001 D1 MONTAJ

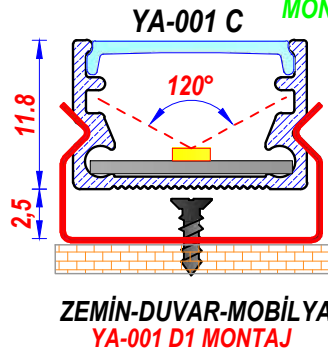

ZEMİN-DUVAR-MOBİLYA  
YA-001 D1 MONTAJ

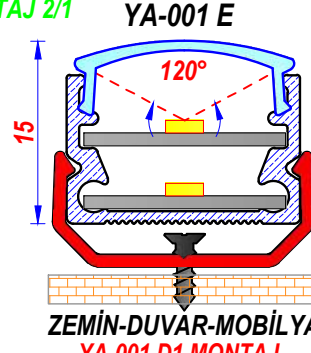

ZEMİN-DUVAR-MOBİLYA  
YA-001 D1 MONTAJ

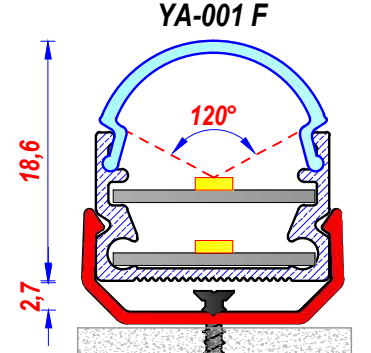

ZEMİN-DUVAR-MOBİLYA

YA 001-YA 001 F PC cam Açılı UYGULAMA

YA-001 F ALM. PRF.



Köşelerde 45° açılı ışık

MONTAJ 2/1

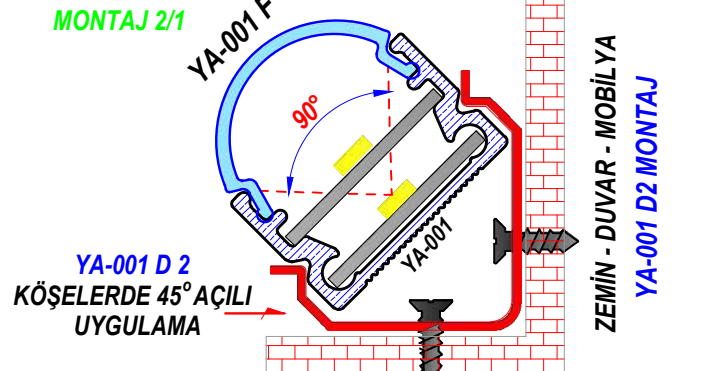

YA-001 D 2  
KÖŞELERDE 45° AÇILI  
UYGULAMA

ZEMİN - DUVAR - MOBİLYA  
YA-001 D2 MONTAJ

**YA-010**

Alm.Led Kasa

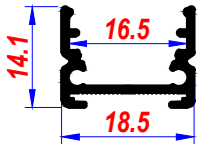

16 mm lik PCB ye uygun

**Mıknatis Uygulama Profili**

YA-010 YA-010 M

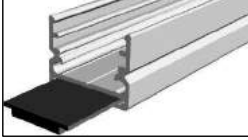

**YA-010 M**

Mıknatis Profili

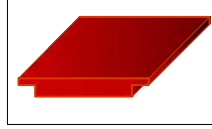

MIKNATIS PRF. 610 cm

*Duvar bağlantı aparatı gerekmeden,  
sıkı geçme mıknatis profille birlikte,  
metal yüzeylere kolay montaj*

**YA-001 E**

Düş.Bom.P.C.Difüzör

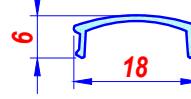

YA-001 E Opal-Şeffaf



**YA-001 F**

Orta Bom.P.C.Difüzör

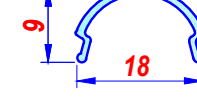

YA-001 F Opal-Şeffaf



**PC.DİFÜZÖR-ALM.PRF. 610 cm**

YA-001 E PC. DİFÜZÖR

YA-001 F PC. DİFÜZÖR

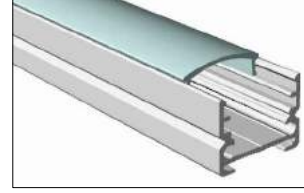

YA-010 ALM.PRF.

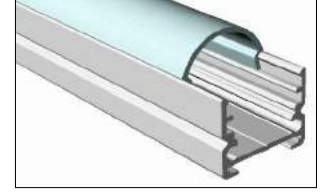

YA-010 ALM.PRF.

**YA-001 A**

U P.C.Difüzör

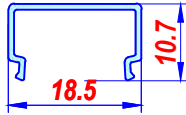

YA-001 A Opal-Şeffaf

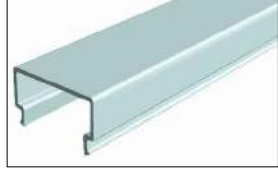

**YA-001 C**

Düz P.C.Difüzör

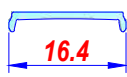

YA-001 C Opal-Şeffaf



**PC.DİFÜZÖR-ALM.PRF. 610 cm**

YA-010 ALM.

YA-010 ALM.

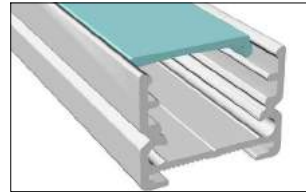
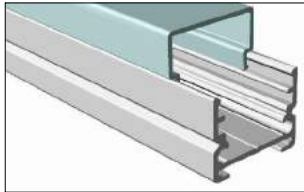

**YA 010 Alm.Prf. ve AKSESUARLARI**

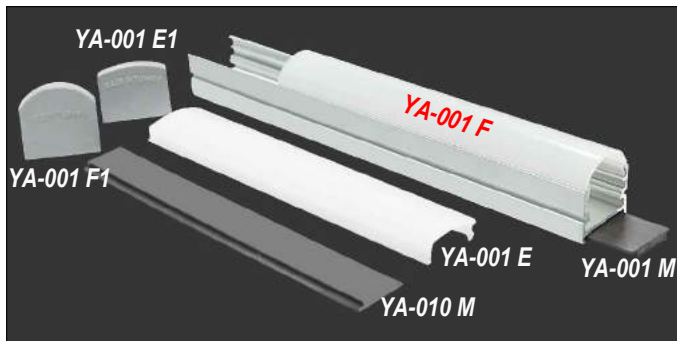

**YA-001 E 1**

Düşük Bom.Pls. tapa



RENK ; Açık Gri

**YA-001 F 1**

Orta Bombeli Pls. tapa



RENK ; Açık Gri

**YA-001 C 1**

Pls. Kenar Tapa

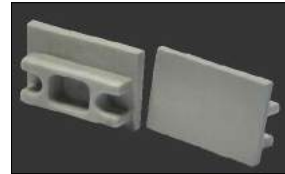

RENK ; Açık Gri

**YA-001 A3**

Yük.Köş.Alm.Tapa



YA 001 A PC.

LAZER

**Dekoratif Sıva Üstü Led Bar Profili**

*Kullanım alanları; Mobilya,  
Mutfak, Zemin, Duvar, vb.*

YA 001 E - YA 001 F - YA 001 C PC. Camlara  
Uygun Pls. Kenar Tapa mevcut

YA 001 A PC.cama uygun Lazer Ken. Tapa mevcut

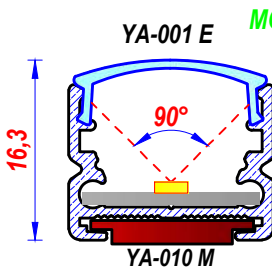

YA-001 E

**MONTAJ 2/1**

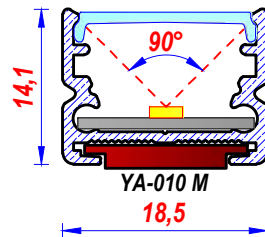

YA-001 C

YA-010 M

18,5

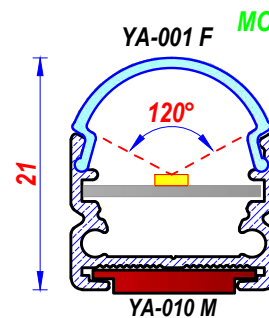

YA-001 F

YA-010 M

**MONTAJ 2/1**

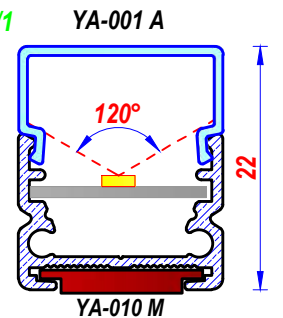

YA-001 A

YA-010 M

YENİ YA-002  
Gömme Alm.Kasa

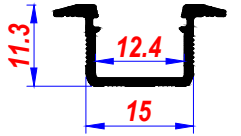

12 mm lik PCB ye uygun

YA-002 A  
P.C. Difüzör



Opal-Şeffaf

YENİ YA-002 P  
P.C. Difüzör



Yeni Ekonomik Cam

YA-002 B  
Pls.Kenar Tapa



RENK ; A.Gri

Kullanım alanları; Mobilya,  
Mutfak, Zemin, Duvar vb.  
Yeni, düz PC.Difüzör

DEKORATİF GÖMME LED PRF.

MONTAJ 2/1

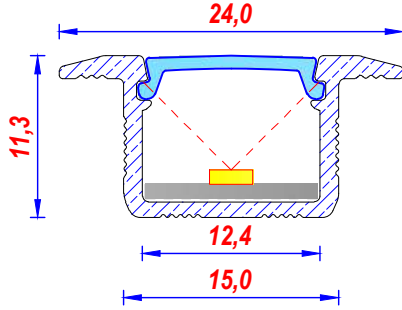

YA-002

YA-002 P

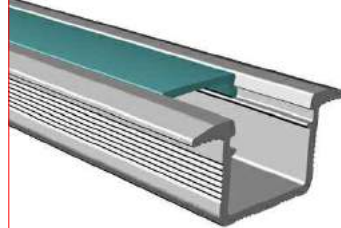

ALM. ve PC DİFÜZÖR 610 cm

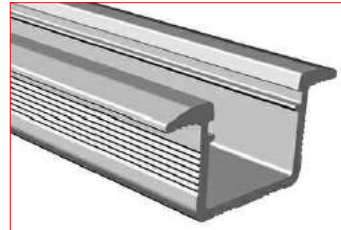

YENİ YA-002 ALM.PRF.

YA 002 ALM. PRF. ve AKSESUARLARI



YA 002 B

YA 002

YA 002 A

YA-1002

Gömme Alm.Kasa

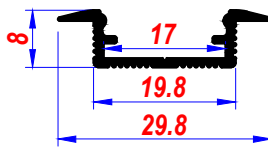

16 mm lik PCB ye uygun

YA-1002 A  
P.C. Difüzör

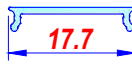

Opal - Şeffaf

YA-1002 T

Pls.Kenar Tapa

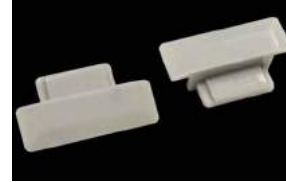

RENK ; A.Gri

MONTAJ 2/1

YA-1002 A

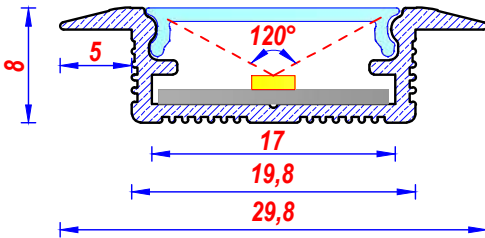

Y-1002 A

Opal - Şeffaf

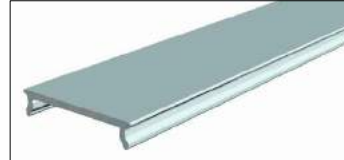

P.C.DİFÜZÖR 610 cm

16 mm lik PCB uygun  
Dekoratif Gömme Led Profili  
Kullanım alanları; Mobilya,  
Mutfak, Zemin, Duvar vb.  
Yüksekliği düşük, H=8 mm

YA-1002

PC.DİFÜZÖR-ALM.PRF. 610 cm

Y-1002 A

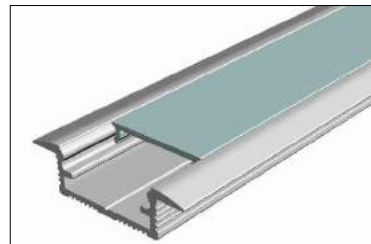

İSTENİLEN ÖLÇÜLERDE KESİM YAPILIR

All cutting dimensions can be done according to requirements

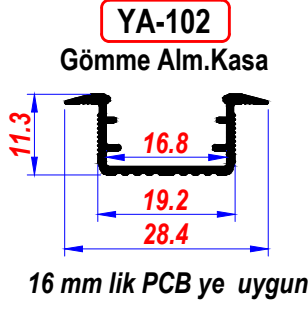

**DEKORATİF GÖMME LED PROFİLİ**



Kullanım alanları; Mobilya,  
Mutfak, Zemin, tavan, Duvar vb.

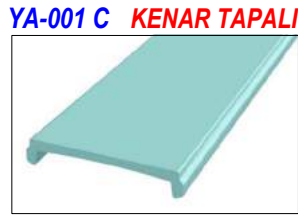
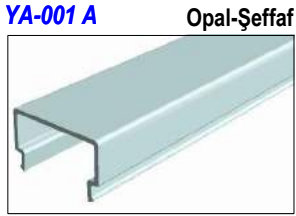
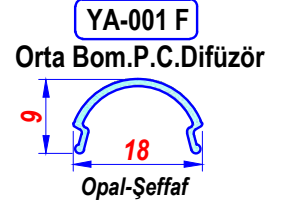
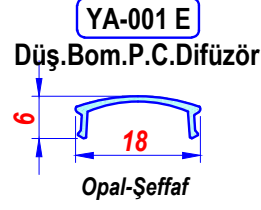
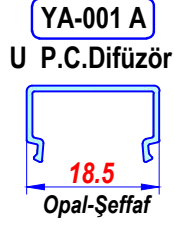

**PC.DİFÜZÖR-ALM.PRF. 610 cm**

**PC.DİFÜZÖR, OPAL-ŞEFFAF**

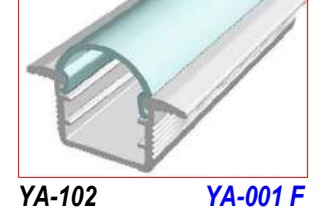
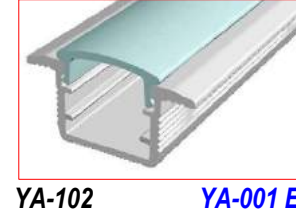
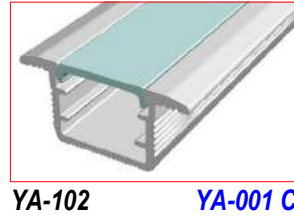
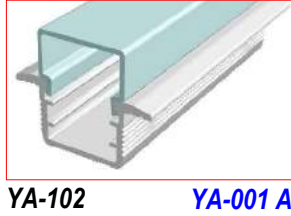

**YA-102 ALM. LED KAS ve AKSESUARLARI**



**İSTENİLEN ÖLÇÜLERDE KESİM YAPILIR**  
All cutting dimensions can be done according to requirements

SIVA ALTI - SIVA ÜSTÜ PLASTİK LED AYDINLATMA PROFİLLERİ

**GP-001**  
Pls.Gömme Led Prf.  
Kulaklı-Açık

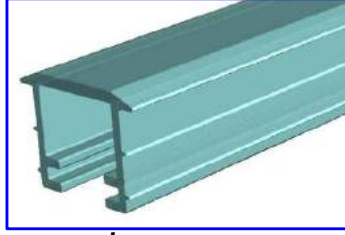
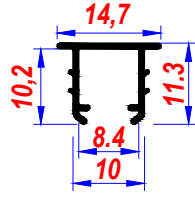

PROFİL 305 cm - OPAL

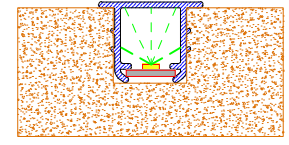

18 mm Sunta Uygulaması

**GP-002**  
Pls.Gömme Led Prf.  
Kulaklı-Açık

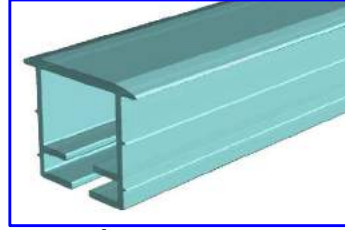
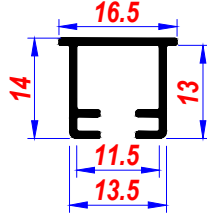

PROFİL 305 cm - OPAL

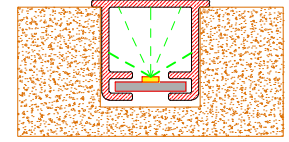

18 mm Sunta Uygulaması

**GP-020**  
Pls.Gömme Led Prf.  
Kulaklı - Kapalı

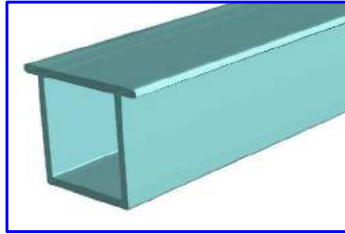
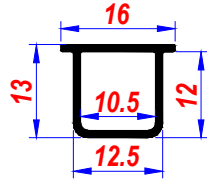

PROFİL 305 cm - OPAL

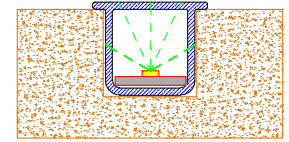

18 mm Sunta Uygulaması

**GP-030**  
Plastik Led Prf.(Açık)

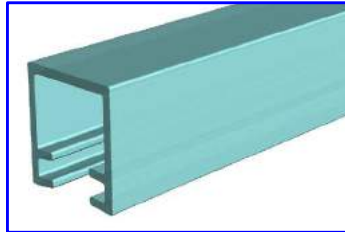
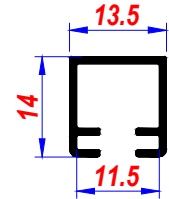

PROFİL 305 cm - OPAL

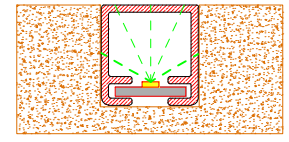

18 mm Sunta Uygulaması

**GP-031**  
Plastik Led Prf.(Açık)  
Yatak Başı

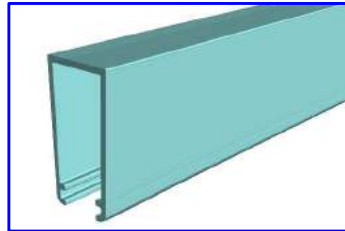
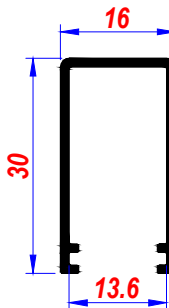

PROFİL 305 cm - OPAL

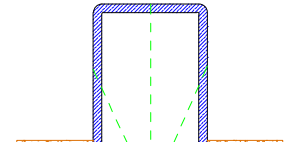

18 mm Sunta Uygulaması

**KULLANIM ALANLARI**

Mobilya,Dolap, Çekmece içi, Seramik,Duvar,Zemin,  
merdiven ve ahşap gibi yerlerde, kullanıma uygun dekoratif  
ve ekonomik siva altı - siva üstü **YENİ ÜRÜNLER**

İSTENİLEN ÖLÇÜLERDE KESİM YAPILIR

All cutting dimensions can be done according to requirements

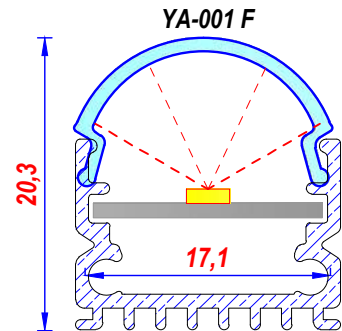
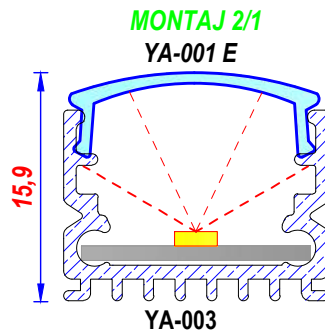
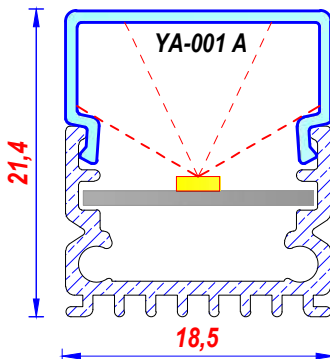
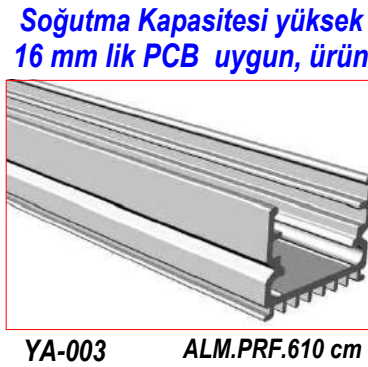
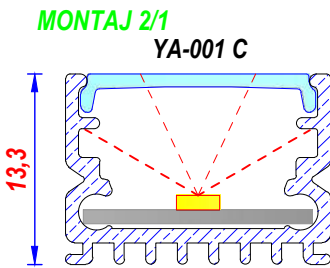
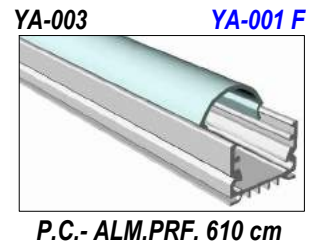
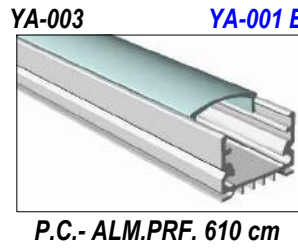
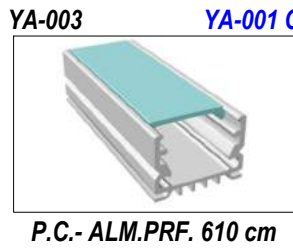
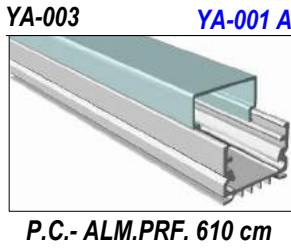
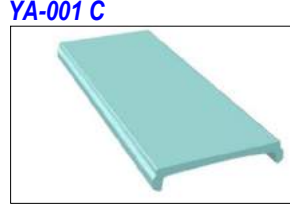
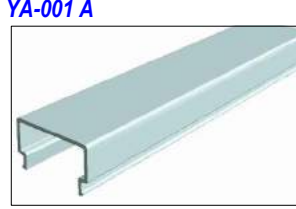
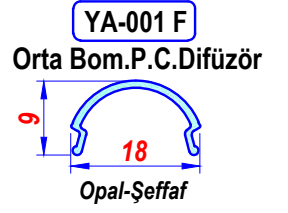
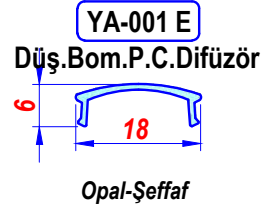
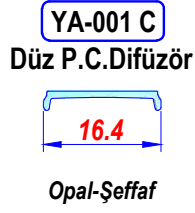
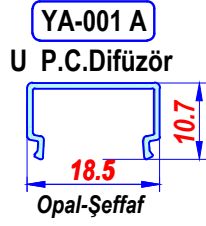
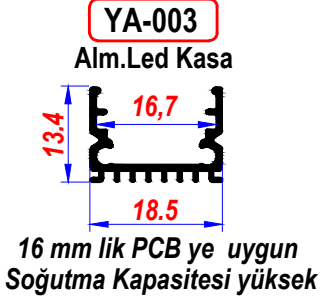

**İSTENİLEN ÖLÇÜLERDE KESİM YAPILIR**  
All cutting dimensions can be done according to requirements

**YA-005**  
Alm.Led Kasa

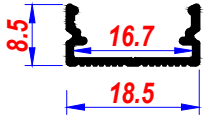

16 mm lik PCB uygun

**YA-001 A**  
U P.C.Difüzör

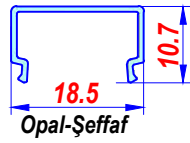

Opal-Şeffaf

**YA-001 C**  
Düz P.C.Difüzör

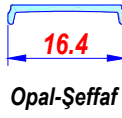

Opal-Şeffaf

**YA-001 E**  
Düş.Bom.P.C.Difüzör

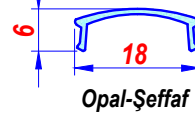

Opal-Şeffaf

**YA-001 F**  
Orta Bom.P.C.Difüzör



Opal-Şeffaf

**YA-001 E** Opal-Şeffaf



**YA-001 F** Opal-Şeffaf



**YA-005 A**

Düşük Bom.Pls. tapa



RENK ; A.Gri

**YA-005 A 1**

Düşük Bom.Pls. tapa



KULAKLI

**YA-005** **YA-001 E**

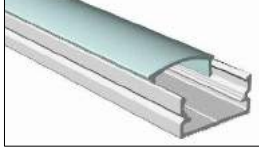

P.C.- ALM.PRF. 610 cm

**YA-005** **YA-001 F**

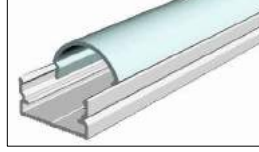

P.C.- ALM.PRF. 610 cm

**YA-005 B**

Orta Bombeli Pls.tapa



RENK ; A.Gri

**YA-005 B 1**

Orta Bombeli Pls. tapa



KULAKLI

**YA-001 E PC. DİFÜZÖR UYGULAMA**



**YA-001 F PC. DİFÜZÖR UYGULAMA**



YA-001 E ve YA 001 F, PC.re uygun 2 şer adet plastik kenar tapa mevcut

**YA-001 D**  
Duvar Bağt.Aprt.

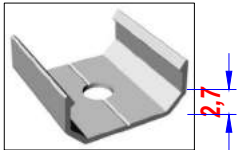

2 cm Alm.

**YA-001 D 1**  
Duvar Bağt.Aprt.



Paslanmaz Çelik

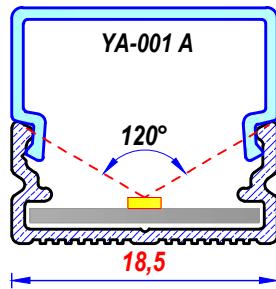

MONTAJ 2/1

21,9

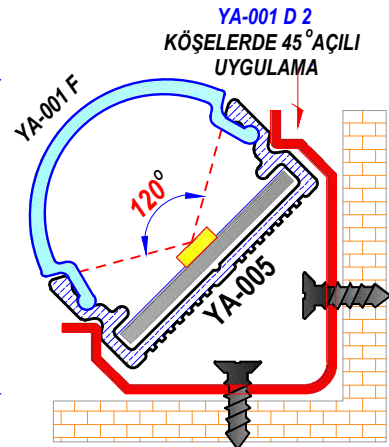

YA-001 D 2  
KÖŞELERDE 45° AÇILI  
UYGULAMA

ZEMİN - DUVAR - MOBİLYA

MONTAJ 2/1

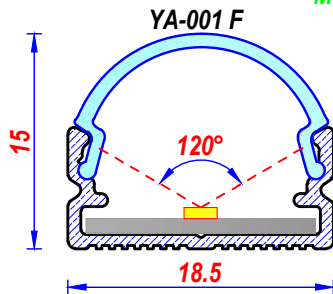

Alm. YA-001 D  
Çelik YA-001 D 1

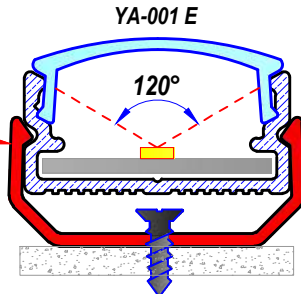

YA-001 D MONTAJ

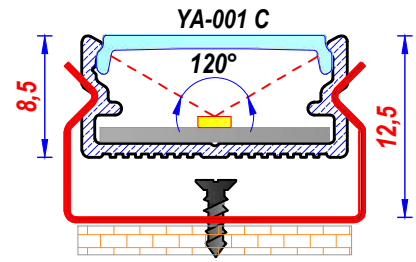

YA-001 D1 MONTAJ

IP 66 YA-006

Alm.Led Kasa

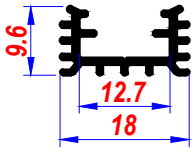

Led yuvası 12,7 mm  
Dış mekan, uygulamalara uygun  
Soğutma kapasitesi yüksek,  
IP 66 ürün

YA 006



YA-006 A

P.C. Difüzör  
Dıştan Montaj



YA 006

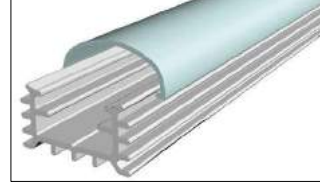

YA-006 B

Pls.Kenar Tapa



RENK: A.GRİ

YA-006 C

Pls.Kenar Tapa

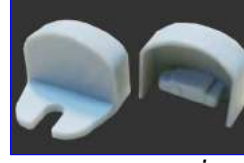

KULAKLI - A.GRİ

YA-001 D

Alm.Duvar Bağlt.Aprt.



GEN. 2 cm

YA-001 D 1

Duvar Bağlt. Aprt.



PASLANMAZ

PC.DİFÜZÖR - ALM.PRF. 610 cm

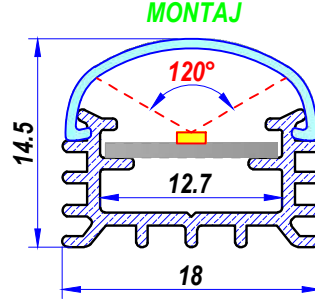

IP 66 YA-007

Alm.Led Kasa

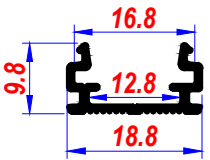

Led yuvası 12 ve 16 mm  
Dış mekan, uygulamalara uygun  
Soğutma kapasitesi yüksek,  
IP 66 ürün

YA 007



YA-006 A

P.C. Difüzör  
Dıştan Montaj

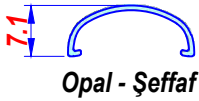

YA 007

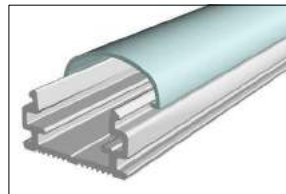

YA-007 A

Pls.Kenar Tapa



YA-007 B

Pls.Kenar Tapa

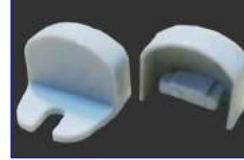

YA-001 D

Alm.Duvar Bağlt. Aprt.



GEN. 2 cm

MONTAJ 2/1

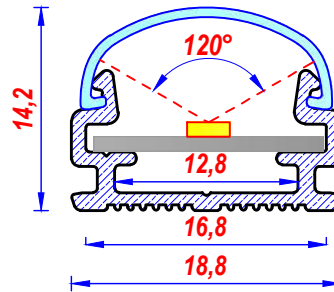

PC.DİFÜZÖR - ALM.PRF. 610 cm

**KULLANIM ALNALARİ**  
Mobilya,Mutfak, Zemin, Duvar vb.  
12-16 mm lik PCB ye uygun  
Dekoratif Sıva Üstü Led Profili  
IP 66

YA-008

Alm.Led Kasa

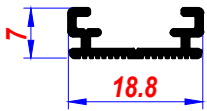

Alt yuva, 12 mm lik PCB ye  
Üst yuva, 16 mm lik PCB ye uygun

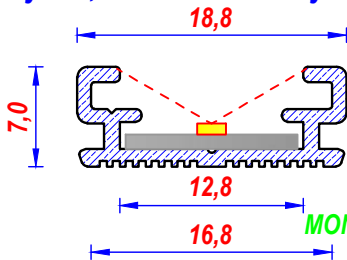

MONTAJ 2/1

İSTENİLEN ÖLÇÜLERDE KESİM YAPILIR  
All cutting dimensions can be done according to requirements

YA 008



ALM.PRF. 610 cm

**KULLANIM ALNALARİ**  
Mobilya,Mutfak, Zemin, Duvar vb.  
12-16 mm lik PCB ye uygun  
Dekoratif Sıva Üstü Led Profili

YA-001 D

Alm.Duvar Bağlt.Aprt.



GEN. 2 cm

YA-001 D 1

Duvar Bağlt. Aprt.



PASLANMAZ

**YENİ YA-009**  
Alm.Led Kasa

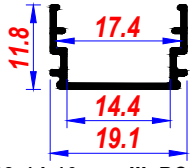

12-14-16 mm lik PCB ye uygun, yeni ürün

**YA-009 YA-009 T**

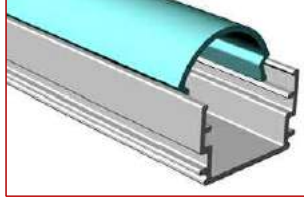

ALM. ve PC.DİFÜZÖR 610 cm

**YA-001 F**  
Orta Bom.P.C.Difüzör

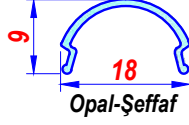

Birbirine takılarak, kablo kanalı ve duvar bağlantı aparatı gibi de kullanıma uygun, **yeni ÜRÜN**

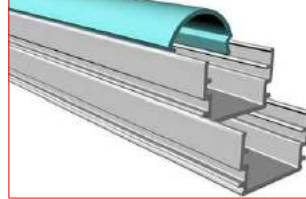

**YA-009 T**  
Pls.Kenar Tapa



YA-001 F cama uygun

YA-001 A, YA-001 C, YA-001 E PC Difüzörler de uygundur. Ancak bunların kenar tapaları yoktur.

**MONTAJ**

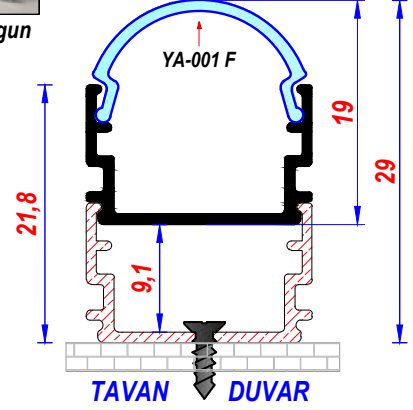

**YA-010**  
Alm.Led Kasa

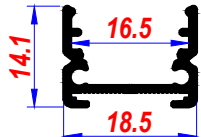

16 mm lik PCB ye uygun

**Mıknatıs Uygulama Profili**

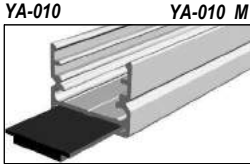

**YA-010 M**  
Mıknatıs Profili

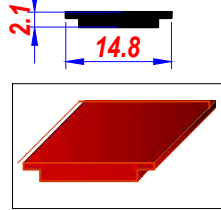

MIKNATIS PRF. 610 cm

Duvar bağlantı aparatı gerekmeden, sıkı geçme mıknatıs profille birlikte, metal yüzeylere kolay montaj. Kullanım alanları; Mobilya, Mutfak, Zemin, Duvar, vb.

**YA-001 A**  
U P.C.Difüzör

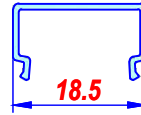

PC.DİFÜZÖR-ALM.PRF. 610 cm  
PC.DİFÜZÖR, OPAL-ŞEFFAF

**YA-001 C**  
Düz P.C.Difüzör

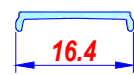

**YA-001 E**  
Düş.Bom.P.C.Difüzör

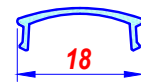

**YA-001 F**  
Orta Bom.P.C.Difüzör



**YA-001 E 1**  
Düşük Bom.Pls. tapa



**YA-001 F 1**  
Orta Bomb. Pls. tapa



RENK ; Açık Gri

**YA-001 C 1**  
Pls. Kenar Tapa



RENK ; Açık Gri

**YA-001 A3**  
Yük.Köş.Alm.Tapa



LAZER

YA 001 A PC.ye uygun

**YA 010 Alm.Prf. ve AKSESUARLARI**

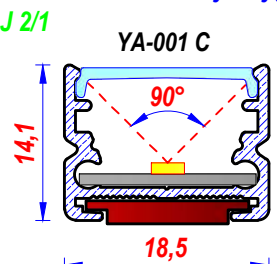
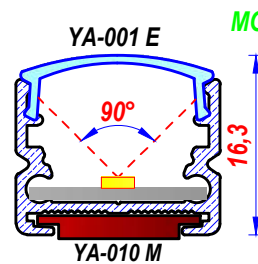
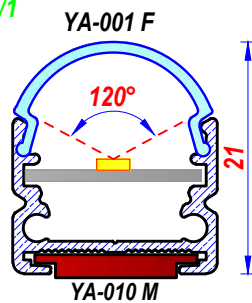
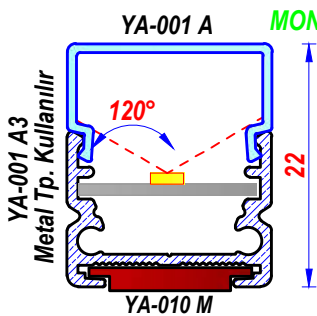
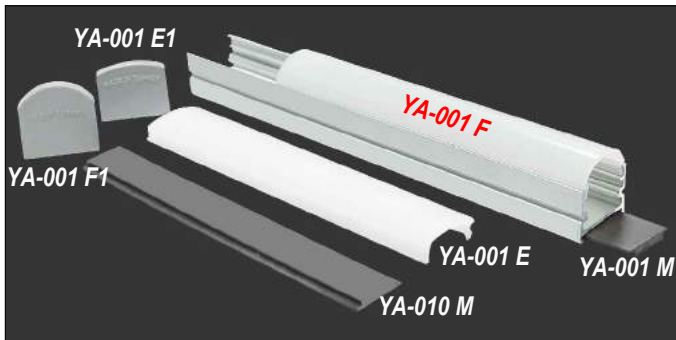

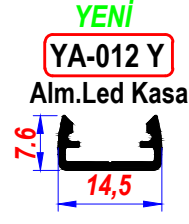
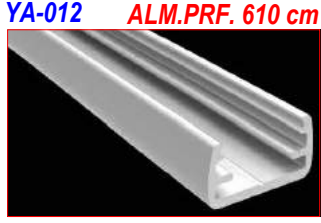
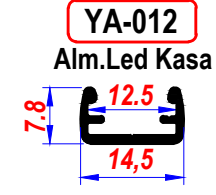

Heriki alüminyum profil, birbirlerine çok benzese de, ürünlerde kullanılan difüzörler farklıdır

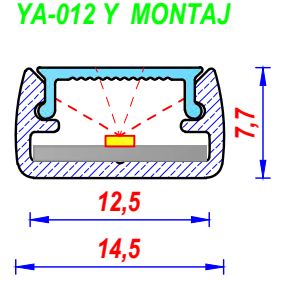
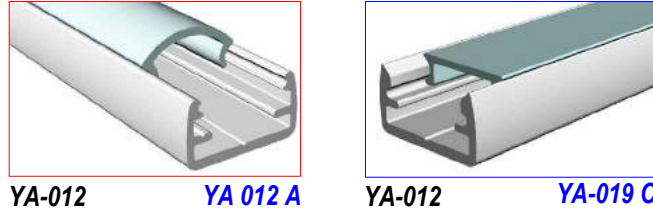
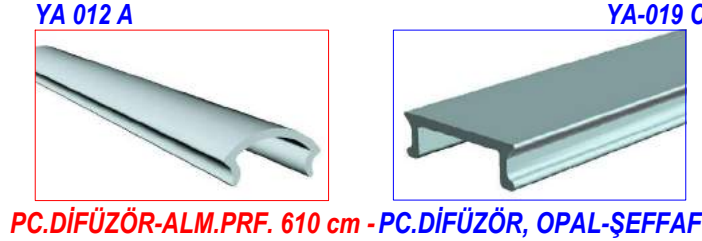
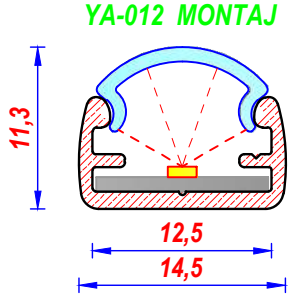

**AKSESUARLAR, HER İKİ ÜRÜNE DE UYGUNDUR**

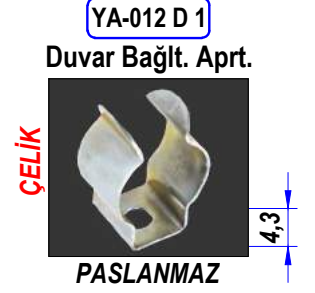

**YA 012 ALM. LED KASA ve AKSESUARLARI**

**İSTENİLEN ÖLÇÜLERDE KESİM YAPILIR**  
All cutting dimensions can be done according to requirements

BUZDOLABI - SOĞUK HAVA DEPOLARI, HAVUZ VE ISLAK ORTAMLAR

YA-013

P.C.Led Kasa  
Difüzör

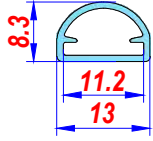

IP 67 ÜRÜN

YA-013 A

Pls.Kenar Tapa



Beyaz-KULAKLI

MONTAJ



MONTAJ 2/1

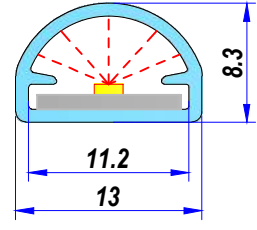

RENK:ŞEFFAF

EKONOMİK LED BAR PROFİLİ

YA-014

Alm.Led Kasa

12 mm lik PCB ye uygun

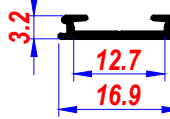

YA-014

YA-006 A



PC.DİFÜZÖR - ALM.PRF. 610 cm

YA-006 A

P.C. Difüzör

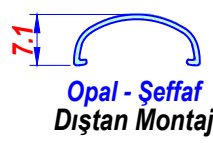

Opal - Şeffaf  
Dıştan Montaj

MONTAJ 2/1

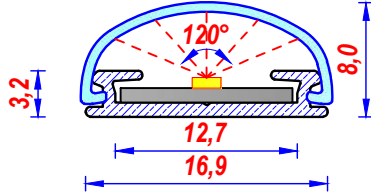

YA-001 D 1

Duvar Bağlt. Aprt.



PASLANMAZ

YA-014 T

Pls.Kenar Tapa



RENK, A.GRI

KULLANIM ALANLARI  
Mobilya,Mutfak, Zemin, Duvar  
Gergi Tavan & Barisol  
Gizli tavan aydınlatma (Havuz)  
Ekonomik Led Profili

EKONOMİK LED BAR PROFİLİ

YA-015

Alm.Led Kasa

12-14 mm lik PCB ye uygun

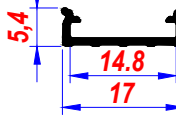

YA-006 A

YA-015



PC.DİFÜZÖR - ALM.PRF. 610 cm

YA-006 A

P.C. Difüzör



Opal - Şeffaf  
Dıştan Montaj

MONTAJ 2/1

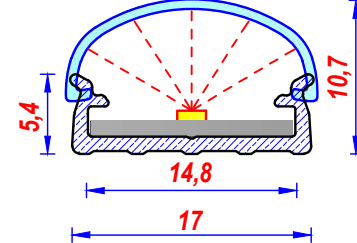

YA-001 D 1

Duvar Bağlt. Aprt.



PASLANMAZ

YA-014 T

Pls.Kenar Tapa



RENK, BEYAZ

KULLANIM ALANLARI  
Mobilya,Mutfak, Zemin, Duvar  
Gergi Tavan & Barisol  
Gizli tavan aydınlatma (Havuz)  
Ekonomik Led Profili

GERGİ TAVAN PROFİLİ

YENİ

YB-001

Alm.Led Kasa  
Gergi Tavan

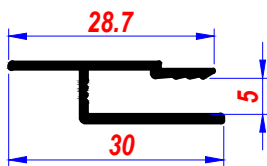

YB - 001

ALM.PRF. 610 cm

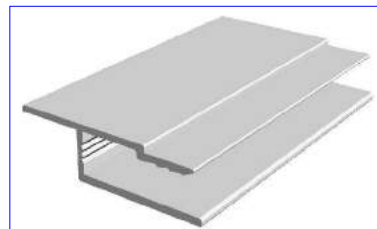

Gergi Tavan & Barisol prf.

GERGİ TAVAN UYGULAMASI

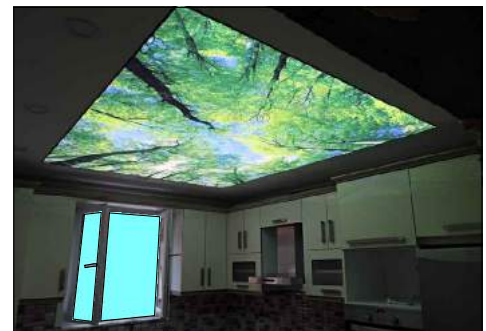

İSTENİLEN ÖLÇÜLERDE KESİM YAPILIR

All cutting dimensions can be done according to requirements

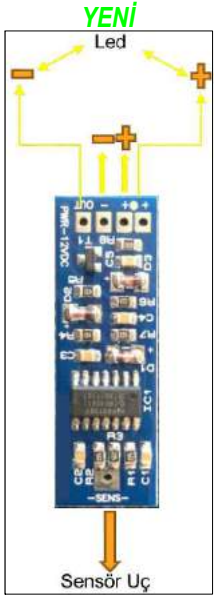

**YA-004 D Dokunmatik Sensör**

**Çalışma aralığı ; 12 volt - 3 Amper**  
**Yanma - sönmeye aralığı 12 - 15 sn**  
**Ürünün kararlı çalışabilmesi için**  
**Yeni Model Adaptör (Switch Mode Power)**  
**ile kullanılması ve topraklama gerekir.**  
**Ebat ; 40 x 13 mm**

**YA-016, YA-019, YA-020, YA-1002 v.b**  
**profiller ile kullanıma uygundur**

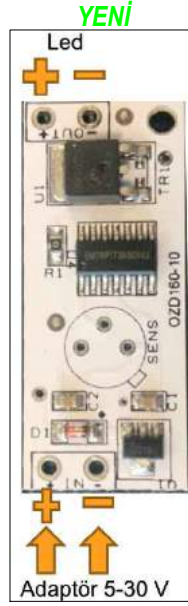

**YA-004 H1 Dijital Hareket Sensörü**

**Çalışma aralığı ; 5-30 volt - 3 Amper**  
**Yanma - sönmeye aralığı 30 sn, 1 dk, 2 dk**  
**Algılama mesafesi; 5 mt**  
**Çıkış Akımı 20 Ampere arttırılabilir**  
**Ebat ; 43 x 18,5 mm**

**YA-001 & YA-002 & YA-003& YA-005,**  
**YA-006 & YA-007 & YA-010 & YA-016,**  
**ve daha büyük profillerle kullanıma uygundur**

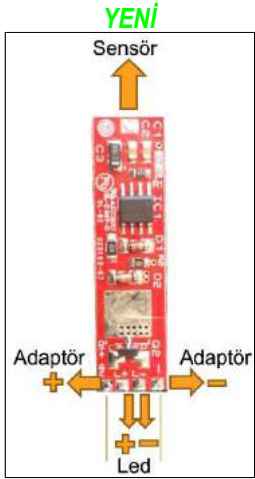

**YA-004 D1 Kademeli Dokunmatik**

**Çalışma aralığı ; 12 V - 3 A**

- 1.kademe; %33
- 2.kademe; %66
- 3.kademe; %100
- 4.kademe; %0

**Ebat ; 41 x 11 mm**

**YA-016, YA-019, YA-020, YA-1002 v.b**  
**profiller ile kullanıma uygundur**



**YA-004 H Hareket Sensörü**

**Çalışma aralığı; 5-30 volt - 4 Amper**  
**Yanma - sönmeye aralığı; 5 sn - 5 dk**  
**Algılama mesafesi; 3 mt**  
**Ebat ; 40 x 11,5 x 15 (H) mm**

**YA-001 & YA-002 & YA-003& YA-005,**  
**YA-006 & YA-007 & YA-010 & YA-016,**  
**ve büyük profillerle kullanıma uygun**

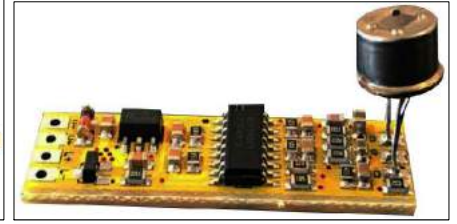

**YA-004 D2 Ayna Dokunmatik**

**Çalışma aralığı ; 12-24 volt - 10 Amper**  
**Algılama mesafesi; 1 cm**  
**Ayna, cam gibi yerlerde kullanılır**  
**Çıkış Akımı 20 Ampere arttırılabilir**

**Sensör dokunmatiği çapı; 2-3 mm.**  
**Mavi ışık sensörün kapalı olduğunu,**  
**Beyaz ışık sensörün açık olduğunu gösterir.**  
**Ebat ; 46 x 30 mm**

**YA-016, YA-019, YA-020, YA-1002 v.b**  
**profiller ile kullanıma uygundur**

**Yeni YA-004 D3 Led Sürücü Koruma Cihazı**

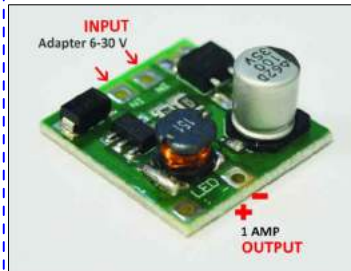

**Çalışma aralığı; 6-30 volt**  
**Çıkış Akımı; 100mA - 1 A**  
**Sürücü ile Led arasında yerleştirilir**  
**Ebat ; 20 x 20 mm**

**Kutupların yanlış bağlanması durumunda**  
**oluşabilecek sigorta arızalarını önler.**

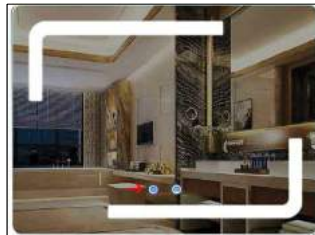

**İSTEĞE ÖZEL SENSÖR TASARIMI YAPILIR**

**All switch designs can be done according to requirements**

YA-016

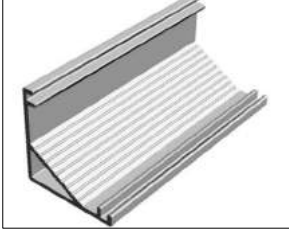

ALM.PRF. 610 cm

YA-016

Alm.Led Kasa

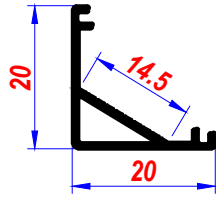

L KÖŞE Profili

12-14 mm lik PCB ye uygun

YA-016 A

Alm.Duvar Bağlantı Prf.

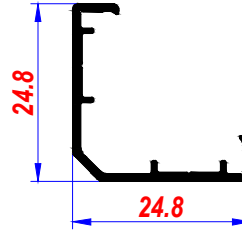

YA-016 A



2 cm-Tek delikli  
Ürün boy halinde de verilir

YA-016 B



P.C. DİFÜZÖR 610 cm

YA-016 B

P.C. Oval Difüzör



Opal - Şeffaf

YA-016 C

P.C. L Difüzör

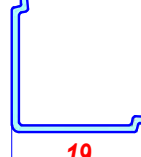

Opal - Şeffaf

YA-016 C

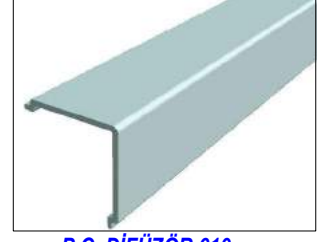

P.C. DİFÜZÖR 610 cm

YA-016 B 1

Kenar Pls. tapa



RENK ; Açık Gri

KULLANIM ALANLARI

45 derece ışık istenilen yerlerde,  
Mutfak tezgah aydınlatma,  
çekmece, dolap içi, zemin,duvar  
köşe birleşim noktalarında kullanılır

YA-016 C 1

Kenar Pls. tapa



RENK ; Açık Gri

YA-016 ALM. LED KASA VE AKSESUARLARI

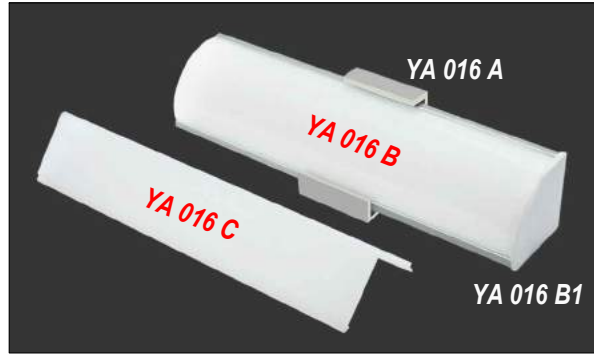

YA-016

YA-016 B

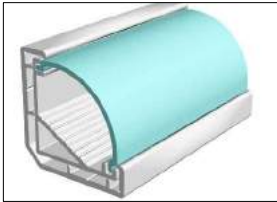

PC.DİFÜZÖR-ALM.PRF. 610 cm

12-14 mm lik PCB uygun

YA-016 YA-016 A YA-016 C

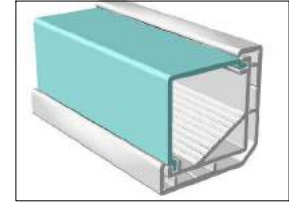

PC.DİFÜZÖR-ALM.PRF. 610 cm

12-14 mm lik PCB uygun

MUTFAK TEZGAH ÜSTÜ 45° AYDINLATMA



OVAL CAM UYGULAMA  
MONTAJ 2/1

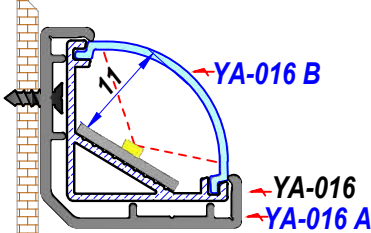

DUVAR-ZEMİN-MOBİLYA

L CAM UYGULAMA  
MONTAJ 2/1

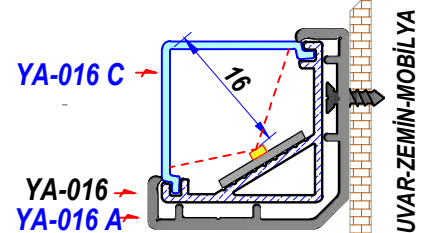

DUVAR-ZEMİN-MOBİLYA

İSTENİLEN ÖLÇÜLERDE KESİM YAPILIR

All cutting dimensions can be done according to requirements

İÇ MEKAN DEKORATİF ÜRÜN (MERDİVEN VB)

YA-017

Alm.Led Kasa

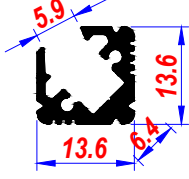

YA-017 A

P.C. Difüzör



YA-017 B

Alm.Lazer Tapa



18 mm SUNTA UYGULAMASI

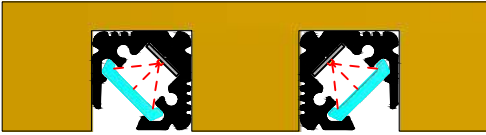

PSB aralığı : 6,4 mm

YA-017 Alm.Prf.ve PC difüzör

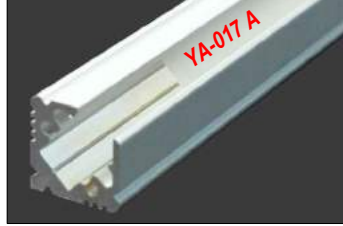

PC.DİFÜZÖR-ALM.PRF. 610 cm



MERDİVEN UYGULAMASI

DIŞ MEKAN, HORTUM - NEON LEDLERE UYGUN ALM. PRF.

YA-018

Alm.Led Kasa

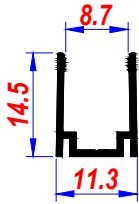

YA-017 Alm.Prf.

NEON LED

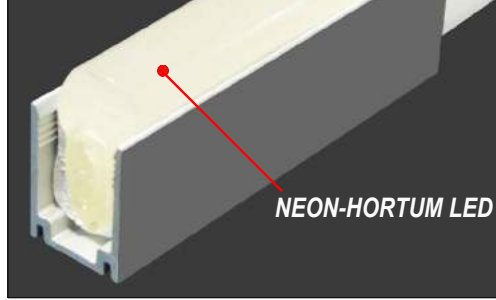

ALM.PRF. 610 cm

MONTAJ 2/1

NEON HORTUM LED

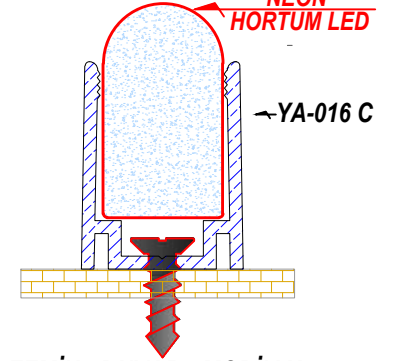

ZEMİN - DUVAR - MOBİLYA

YA-1005

Alm.Led Kasa

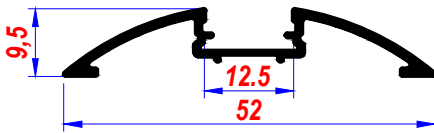

12 mm lik PCB ye uygun

YA-002 A

P.C. Difüzör



YA-002 A



YA-1005 A



YA-1005 A

Alm.Duvar Bağlt. Prf.

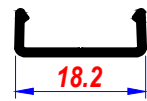

YA-1005

YA-002 A

YA-1005 A

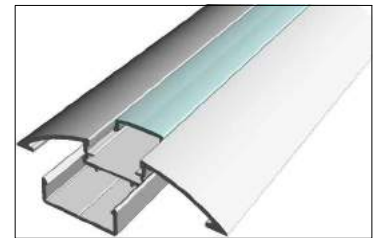

PC.DİFÜZÖR-ALM.PRF. 610 cm

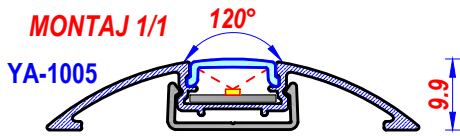

12 mm lik PCB uygun  
Dekoratif Sıva Üstü Led Profili  
Kullanım alanları; Mobilya,  
Mutfak, Zemin, Duvar vb.

İSTENİLEN ÖLÇÜLERDE KESİM YAPILIR

All cutting dimensions can be done according to requirements

**MİNİK EKONOMİK, SIVA ÜSTÜ ALM. LED PROFİL VE AKSESUARLARI**

**YA - 019**

Alm.Led Kasa

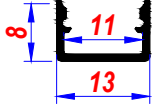

PCB genişliği, 11 mm

YA-019



ALM.PRF. 610 cm

**MONTAJ 2/1**

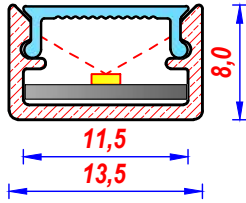

**KULLANIM ALANLARI**

Avize-Mobilya ( Dolap ve çekmece içi ),  
Seramik-Duvar-Zemin-Merdiven-Ahşap gibi,  
yüzelerde, sıfır veya siva üstü kullanıma uygun,  
Dekoratif ve ekonomik minik, **siva üstü ÜRÜN**

**YENİ**

**YA-019 C**

PC.Cam-Difüzör

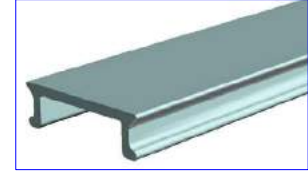

YA-019 C Opal - Şeffaf

**YA-019 T**

Kenar Pls. tapa



RENK ; Açık Gri

YA-019

YA-019 C

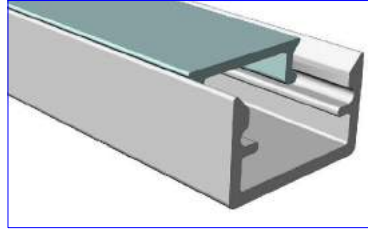

PC.CAM - ALM.PRF. 610 cm

Alüminyum profil, büküme  
uygun evsafda da üretilebilir

**MİNİK EKONOMİK SIVA ALTI, ALM. LED PROFİL VE AKSESUARLARI**

**YA - 020**

Alm.Led Kasa

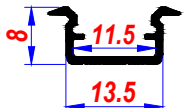

PCB genişliği, 11,5 mm

YA-020



ALM.PRF. 610 cm

**MONTAJ YA-020**

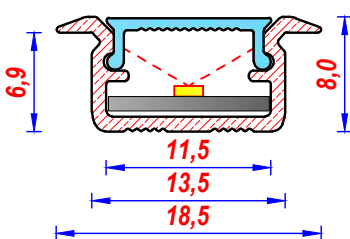

YA-020

YA-019 C-Çizgili

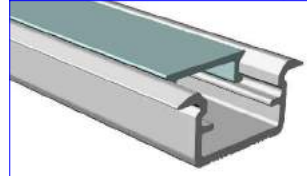

PC.DİFÜZÖR-ALM.PRF. 610 cm

YA-031

YA-019 C-Çizgili

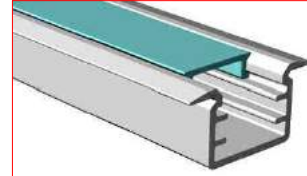

**YENİ**

**YA - 031**

Alm.Led Kasa

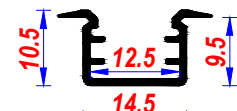

PCB genişliği, 12,5 mm

YA-031

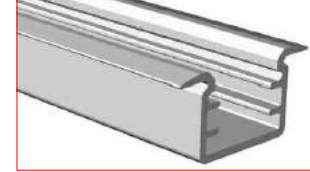

ALM.PRF. 610 cm

**MONTAJ YA-031**

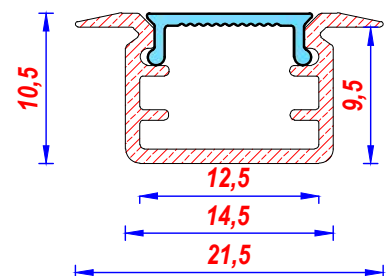

**KULLANIM ALANLARI**

Mobilya ( Dolap ve çekmece içi ),  
Seramik-Duvar-Zemin-Merdiven  
ahşap gibi yüzelerde kullanıma,  
uygun,Dekoratif ve ekonomik  
minik, **siva altı ÜRÜNLER**

YA-031 diğerine göre, daha geniş  
ve daha yüksektir

İSTENİLEN ÖLÇÜLERDE KESİM YAPILIR

All cutting dimensions can be done according to requirements

DIŐ MEKAN ZEMİN, SIVA ALTI ALM. LED PROFİL VE AKSESUARLARI

YA - 022  
Alm.Led Kasa

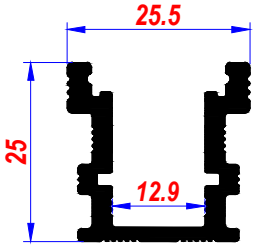

PCB genişliđi, 12,9 mm

YA-022 ALM.PRF. 610 cm

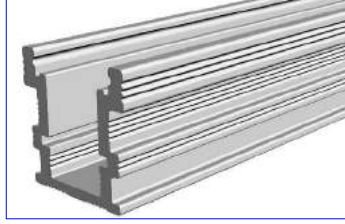

YA-022 C  
P.C.Cam-Difüzör

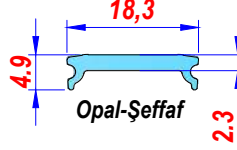

YA-022 T  
Pls. Kenar Tapa

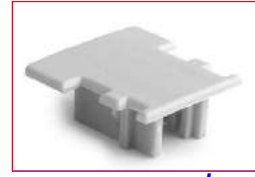

RENK : A.GRİ

Ürün, standart yüklere karşı dayanıklıdır.  
Üründe, sonlandırma tapaları ve PC. Difüzörün  
sızdırmazlık sağlaması için, mutlaka kaliteli  
şeffaf silikon kullanılması gerekmektedir

YÜRÜYÜŐ YOLU-OTOPARK - OTO YOLU VB

MONTAJ 1/1

SIVI CONTA

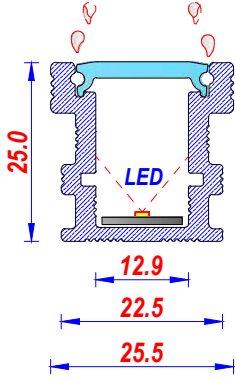

BORDÜR TAŐI, UYGULAMA ŐEKLİ



BORDÜR ZEMİNDE, DÜZ VE EĐİMLİ UYGULAMA



İÇ MEKAN, DEKORATİF-KÜÇÜK SIVA ÜSTÜ ALM. PROFİL VE AKSESUARLARI

YA-023 B  
Alm.Led Kasa  
(Montaj Prf.)

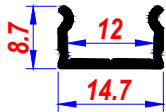

YA-023 B



ALM.PRF.610 cm

YA-012 A  
P.C. Difüzör



Opal - Şeffaf

YA-023 B YA-012 A

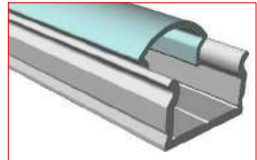

PC.CAM - ALM.PRF. 610 cm

YA-019 C  
P.C. Difüzör



Opal - Şeffaf

YA-023 B YA-019 C

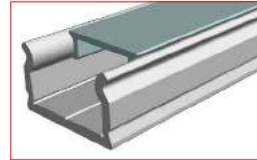

YA-019 T

Kenar Pls. tapa



RENK ; Açık Gri

YA-012 D

Duv.Bğlt.Aprt.



PASLANMAZ

YA-023 B Duvar Bağlantı Profili, 2 farklı  
PC.cam ve çelik klipsle de, ayrı minik  
çizgisel aydınlatmaya uygundur

YA-023 B ALM. LED KASA ve AKSESUARLARI

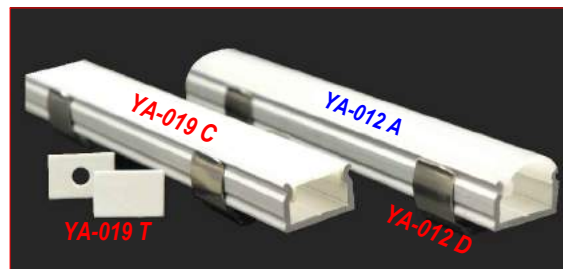

KULLANIM ALANLARI

Mobilya-Duvar-Zemin-Merdiven-ağşap  
gibi yüzelerde kullanıma, uygun, dekoratif  
ve ekonomik minik, siva üstü ÜRÜN

YA-019 T Kenar tapa, YA-012 C  
Difüzöre uygundur

All cutting dimensions can be done according to requirements

İÇ MEKAN, SIVA ÜSTÜ ALM. LED PROFİL VE AKSESUARLARI

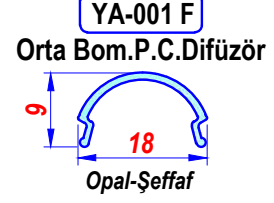
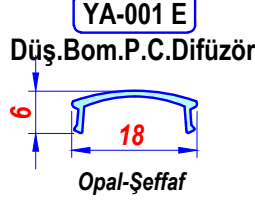
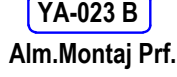
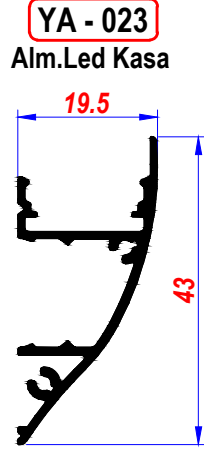

**KULLANIM ALANLARI**

Mobilya, Süpürgelik, Duvar, Bordür  
Aplik vb, kullanıma uygun, dekoratif ürün

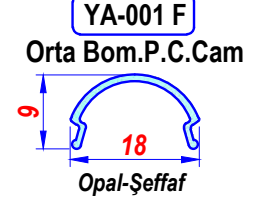
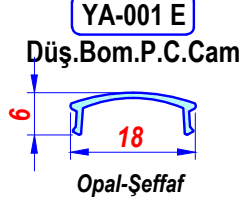
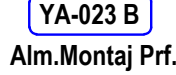
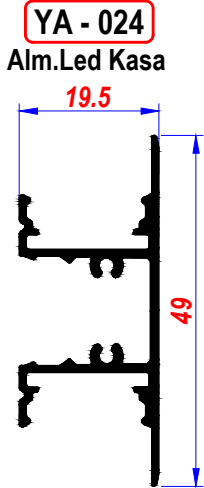
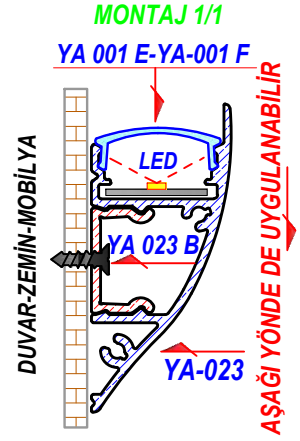
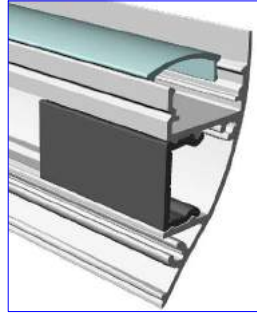
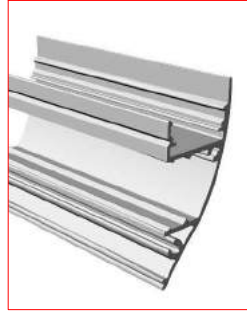
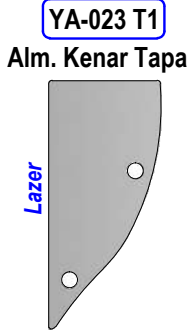

**KULLANIM ALANLARI**

Mobilya, Süpürgelik, Duvar, Bordür  
İki yönlü Aplik vb, kullanıma uygun ürün

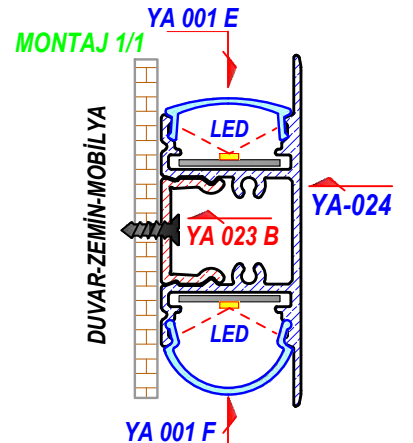
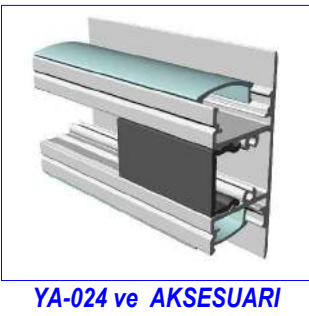
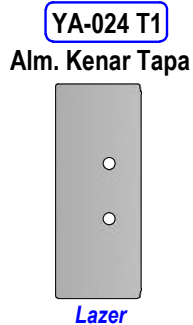

İSTENİLEN ÖLÇÜLERDE KESİM YAPILIR  
All cutting dimensions can be done according to requirements

### KULLANIM ALANLARI

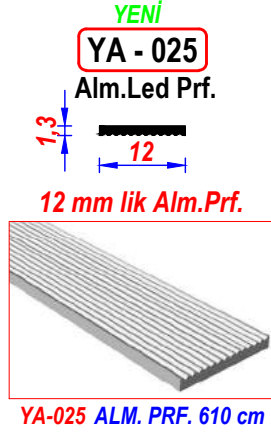

Şerit led yapıştırılarak kullanılan,  
10,12,15 ve 16 mm lik Alüminyum profiller

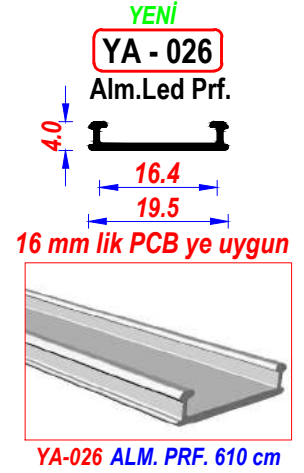
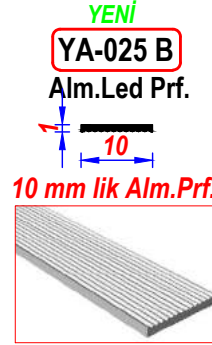
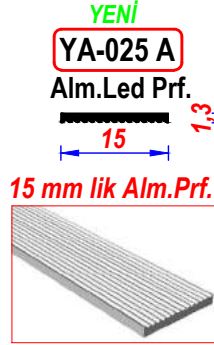

### MİNİK L KÖŞE ALM. PROFİL VE AKSESUARLARI

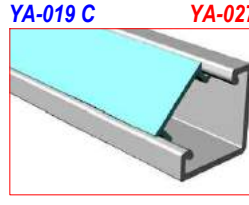
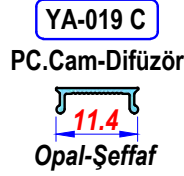
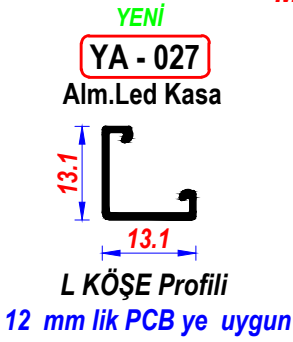

PC.CAM-ALM.PRF. 610 cm



**YA-012 T** YAKINDA  
Pls. Kenar Tapa

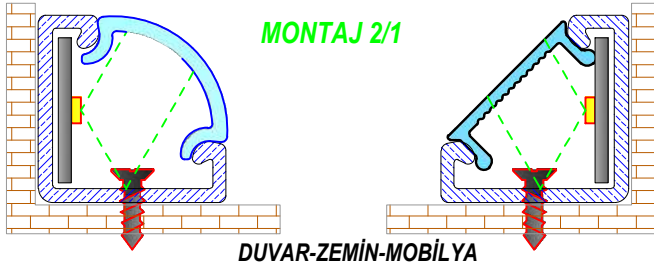

**KULLANIM ALANLARI**  
Mobilya ( Dolap ve çekmece içi ),  
Mutfak dolap altlarında kullanıma  
uygun, dekoratif ve ekonomik  
minik sıva üstü köşe profili...  
Plastik kenar tapa ve montaj  
klipsi, çok yakında

### SIVA ALTI-GÖMME ALM. LED PROFİL VE AKSESUARLARI

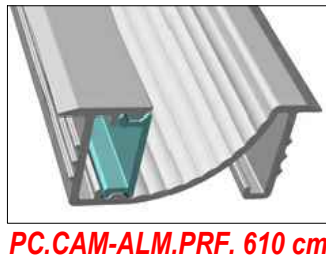
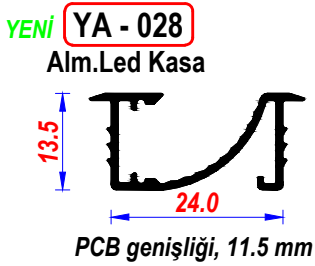

PC.CAM-ALM.PRF. 610 cm

RENK : A.GRİ

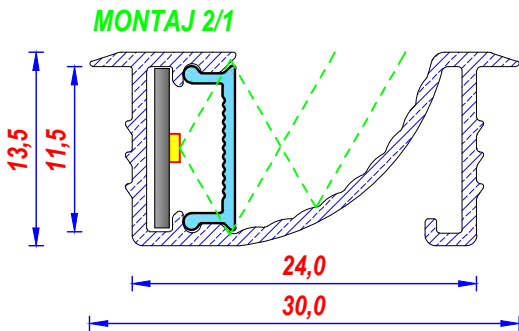

**KULLANIM ALANLARI**  
Mobilya ( Dolap ve çekmece içi ), Duvar-zemin  
Merdiven-aşşap gibi yüzeylerde, sıva altı  
kullanımlara uygun, ışık kaynağı görülmeyen,  
(Endirekt aydınlatma) sıva altı yeni ürün

All cutting dimensions can be done according to requirements

IP 66 YA UYGUN 2 ÇEŞİT PC CAM SEÇEĞİ

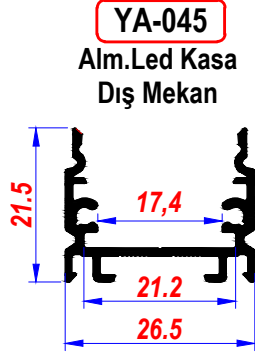

IP 65 Uygun, İç-Dış Mekan Ürün  
NEON Led, Modül led ve  
3 cipli şerit ledlere uygun

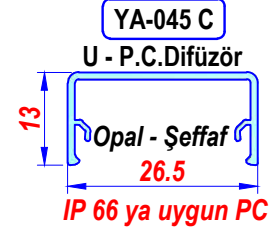
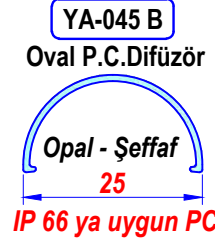

Üç farklı P.Carbon cam, seçeneği  
Gerektiğinde Sarkıt olarak da uygulanır  
IP 65 uygun PC cam, seçenekleri

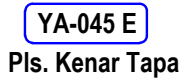

YA-045 A Difüzöre uygun

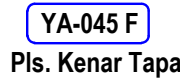

YA-045 C Difüzöre uygun

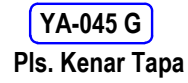

YA-045 B Difüzöre uygun

YA 045 A - YA 045 C PC DİFÜZÖR UYGULAMA

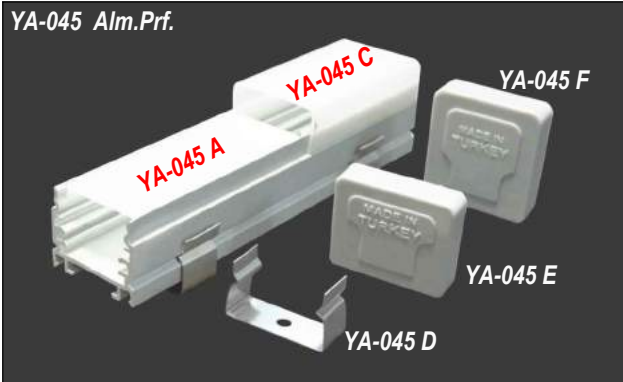

YA 045 B PC DİFÜZÖR UYGULAMA

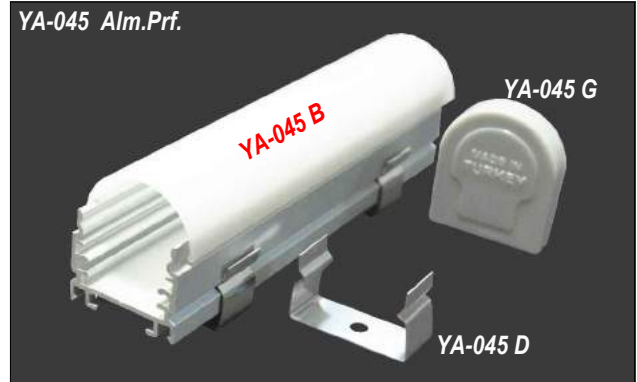

PC.DİFÜZÖR-ALM.PR.F. 610 cm

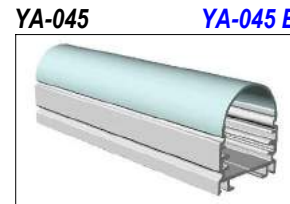
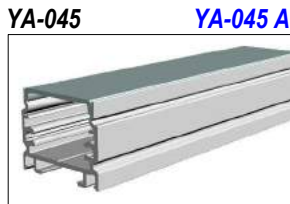

PC.DİFÜZÖR-ALM.PR.F. 610 cm

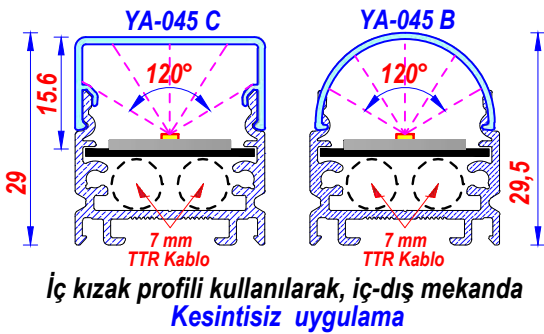
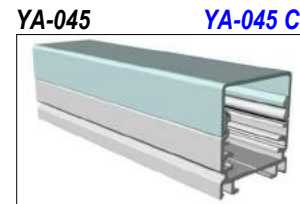

İç kızak profili kullanılarak, iç-dış mekanda  
Kesintisiz uygulama

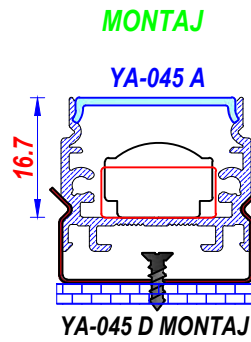

YA-045 D MONTAJ

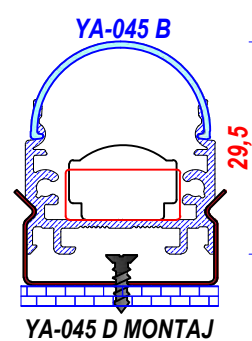

YA-045 D MONTAJ

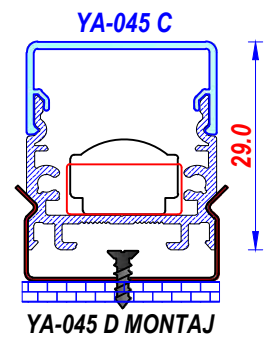

YA-045 D MONTAJ

YA-057

Alm.Led Kasa  
Sabit kızaklı

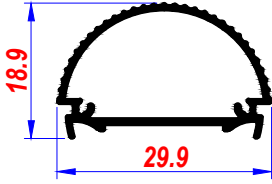

YA-057

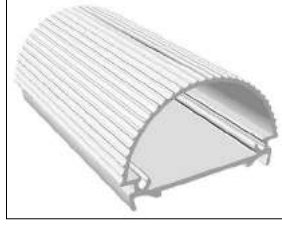

ALM. PRF. 610 cm

YA-058

Alm.Led Kasa  
Hareketli Kızaklı

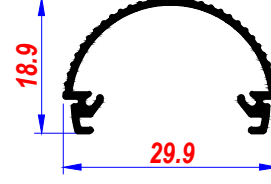

YA-058

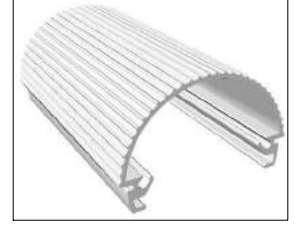

ALM. PRF. 610 cm

YA-057 A

P.C. Cam

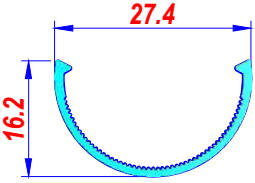

YA-057 A



P.C. DİFÜZÖR 610 cm

YA-058 A

Alm.Kızak Prf.

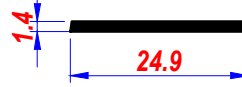

YA-058 B

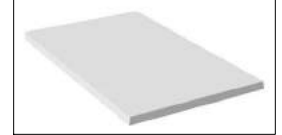

ALM. PRF. 610 cm

YA-057 / YA-058 UYUMLU  
Opal - Şeffaf

LİNEER KUULLANIMA UYGUN ÜRÜN

YA-057 B

PBT Kenar Tapa

Faturalı

RENK ; Beyaz



YA-057 C

PBT Kenar Tapa

Faturasız

RENK ; Beyaz



YA-057 C

ALM. Kenar Tapa

RENK ; A.Gri

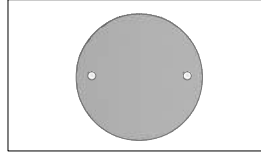

YA-057 / YA-058 UYUMLU

YA-057 / YA-058 UYUMLU

YA-057 / YA-058 UYUMLU

YA-057 D

Floresan tavan Bağlantı  
Aparatı ( PVC )



YA-057 / YA-058 UYUMLU



RENK : Beyaz

YA-058

YA-058 A

YA-057 A



P.C.PRF. - ALM. PRF. 610 cm

YA-057

YA-057 A

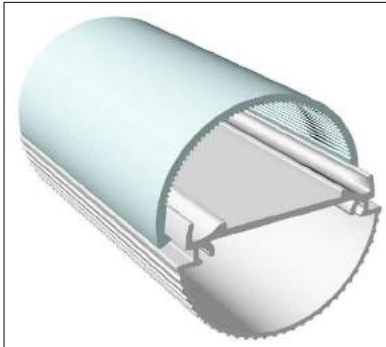

PC.DİFÜZÖR-ALM.PRF. 610 cm

YA-057

YA-057 A

YA-057 B



P.C.PRF. - ALM. PRF. 610 cm

60 ve 120 cm lik takım halinde,  
farklı ölçü ve uzunluklarda kesilir

YA-058

YA-057 A

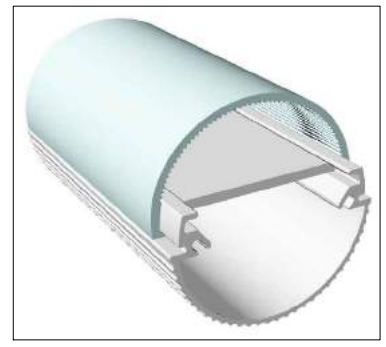

PC.DİFÜZÖR-ALM.PRF. 610 cm

İSTENİLEN ÖLÇÜLERDE KESİM YAPILIR

All cutting dimensions can be done according to requirements

İÇ MEKAN, LED IŞIKLI MERDİVEN BURUNLUK PROFİLİ

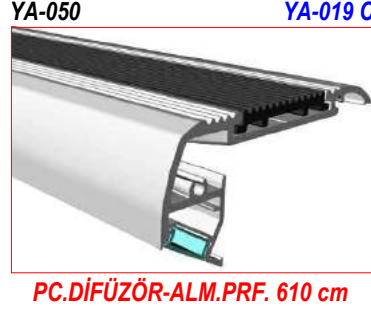
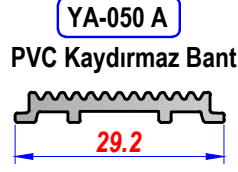
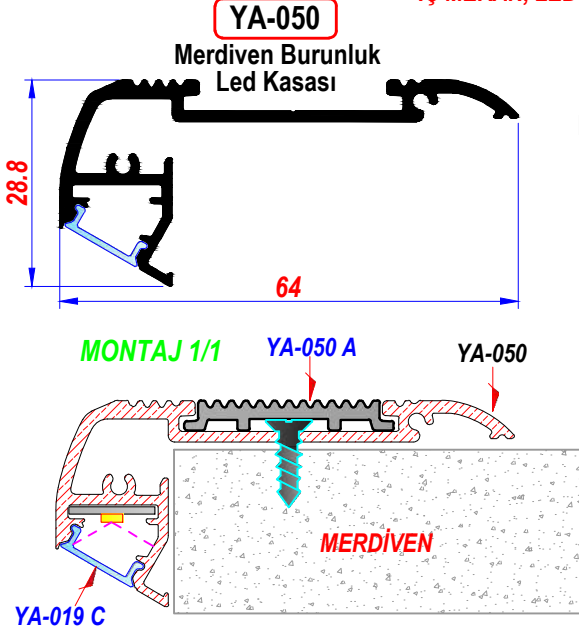

MERDİVEN UYGULAMASI



**YA-049**  
Merdiven Bur.Led Kasa

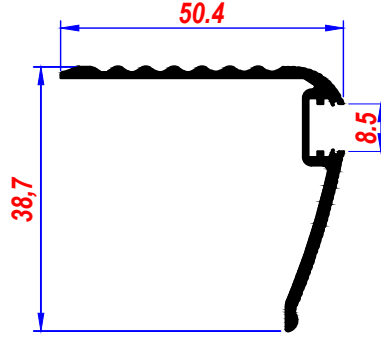
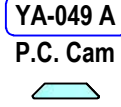

**YA-055**  
Alm.Led Kasa

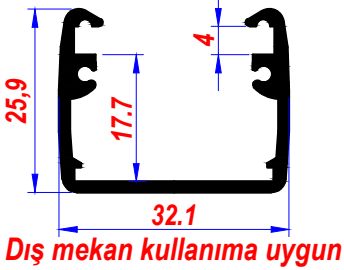

**YA-055 A**  
Pls.Tapa - Conta



**YA-055 B**  
Alm. Kenar Tapa



**YA-055 C**  
Alm. Kenar Tapa



**YA-L1**  
Polikarbon Lens

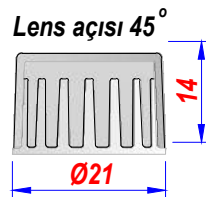

LENS; Ayrıca, duvar boyama, projektör ve sokak armatür kasalarında kullanıma uygundur...

YA-055 ALM. LED KASA VE AKSESUARLARI



Trafik araçlarında, acil durum uyarı sistemlerinde, Lineer aydınlatmalarda kullanıma uygundur

İSTENİLEN ÖLÇÜLERDE KESİM YAPILIR

All cutting dimensions can be done according to requirements

ALM. LED - AVİZE PROFİL VE AKSESUARLARI

AVZ-001

Alm.Led-Avize Kasa

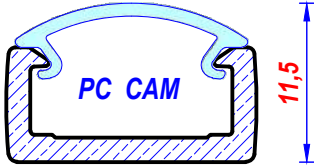
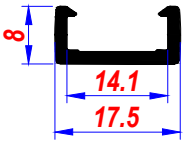

MONTAJ 2/1

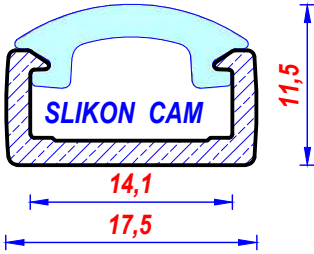

Yeni Aksesuarların tamamı,  
kaplamaya uygun üretilmiştir.  
Plastik Aksesuarlar istenilen  
renkte üretilir

AVZ-001 P

PC Cam-Difüzör



ALM.-PC.PRF. 610 cm

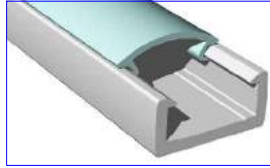

AVZ-001 S

Silikon Cam-Difüzör

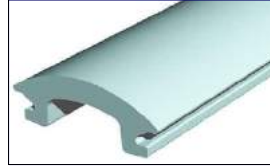

SİLİKON DİFÜZÖR 25 mt

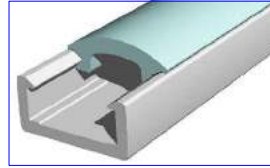

AVZ-001 PS

Modifiye Silikon



EKONOMİK YENİ ÜRÜN

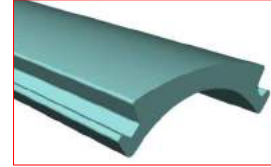

MODİFİYE DİFÜZÖR 25 mt

AVZ-001 T

Pls. Kenar Tapa



AVZ-001 T1

Pls.Rözens Bağlt.Aparatı



MODERN LED AVİZE UYGULAMASI



YENİ AVZ-001 AN

Pls. Askı Aparatı

A.gri-Naturel



ALTTAN NİPELLİ

YENİ AVZ-001 TN

Pls. Askı Aparatı

A.gri-Naturel



ÜSTTEN NİPELLİ

YENİ AVZ-001 YN

Pls. Askı Aparatı

A.gri-Naturel



YANDAN NİPELLİ

Yeni Üretilen Plastik askı aparatları, çap 9,5 mm lik NİPEL e uygundur  
Büküme uygun sertlikde, alüminyum profil satışa sunulmuştur

YENİ AVZ-001 DY

Pls. Vidalı Ayıp Örtün Aparatı

A.gri-Naturel



YENİ AVZ-001 AY

Pls. Ayıp Örtün Aparatı

A.gri-Naturel



YENİ AVZ-001 HN

Pls. Askı Aparatı

A.gri-Naturel



AVZ-001 HN YENİ

Alm. Askı Aparatı



İSTENİLEN ÖLÇÜLERDE KESİM YAPILIR

All cutting dimensions can be done according to requirements

DAİRESEL ALM. LED - AVİZE PROFİL VE AKSESUARLARI

AVZ-002

Alm.Led-Avize Kasa

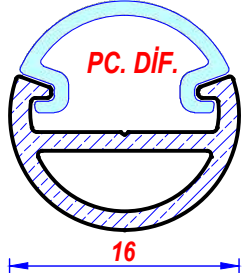
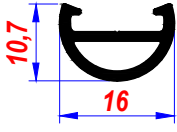

MONTAJ

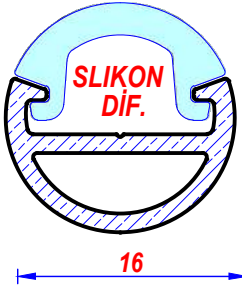

AVZ-002 P

PC Cam-Difüzör



ALM.-PC.PRF. 610 cm



AVZ-002 S

Silikon Cam-Difüzör



SİLİKON DİFÜZÖR 25 mt

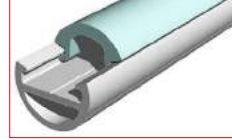

AVZ-002 T

Metal. Kenar Tapa



Ürün Sonlandırma tapası

BÜKÜME UYGUN SERTLİKTE,  
TEK YÖNLÜ DAİRESEL ALÜMİNYUM PROFİL

MODERN LED AVİZE UYGULAMALARI

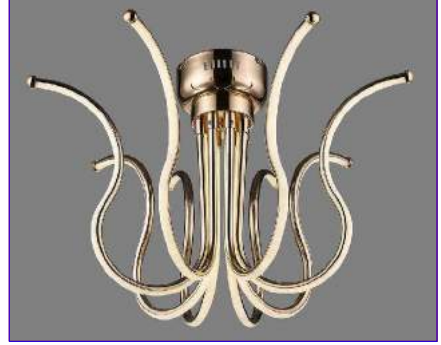

Krom kaplamaya uygun , Kenar Tapa  
Büküme uygun sertlik de, alm. prf. üretimi  
Pls. kenar tapalar, istenilen renk de üretilir



İKİ YÖNLÜ DAİRESEL ALM. LED - AVİZE PROFİL VE AKSESUARLARI

AVZ-003

Alm.Led-Avize Kasa

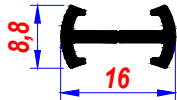

BÜKÜME UYGUN SERTLİKTE,  
ÇİFT YÖNLÜ ALÜMİNYUM PROFİL

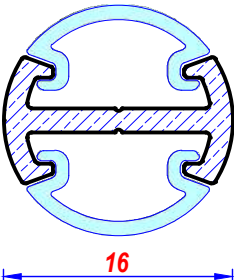

MONTAJ

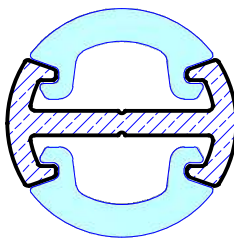

AVZ-003 P

PC Cam-Difüzör



ALM.-PC.PRF. 610 cm



AVZ-003 S

Silikon Cam-Difüzör

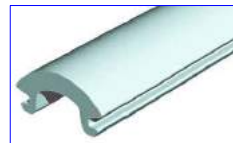

SİLİKON DİFÜZÖR 25 mt

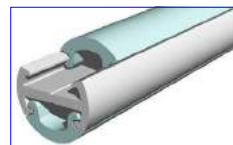

PC. ve SLİKON Difüzör rengi, OPAL

AVZ-002 T

Metal. Kenar Tapa



Ürün Sonlandırma tapası

ÇİFT YÖNLÜ DİFÜZÖR

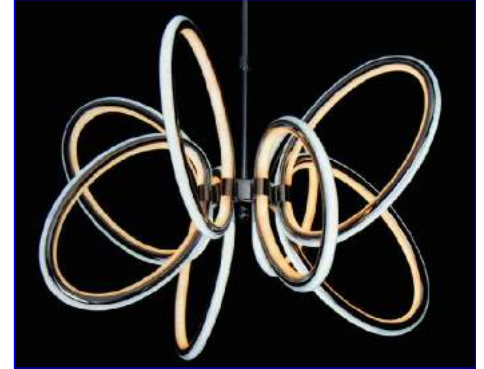

İKİ FARKLI, MODERN LED  
AVİZE UYGULAMASI



ÇİFT YÖNLÜ ALÜMİNYUM

All cutting dimensions can be done according to requirements

AVZ-005

Alm.Led-Avize Kasa

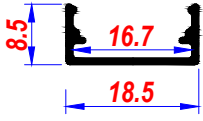

YA-001 A

U P.C.Difüzör

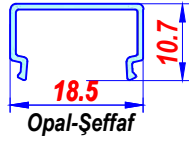

YA-001 C

Düz P.C.Difüzör



YA-001 E

Düş.Bom.P.C.Difüzör

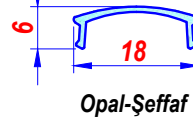

YA-001 F

Orta Bom.P.C.Difüzör

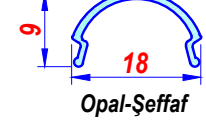

YA-001 E Opal-Şeffaf



YA-001 F Opal-Şeffaf



YA-005 A

Düşük Bom.Pls. tapa



YA-005 B

Orta Bombeli Pls.tapa



YA-005 YA-001 E

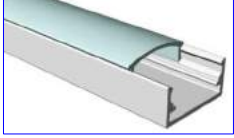

YA-005 YA-001 F

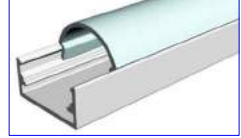

P.C.- ALM.PRF. 610 cm

P.C.- ALM.PRF. 610 cm

MODERN, LED AVİZE UYGULAMASI



## İKİ YÖNLÜ ALM. LED - AVİZE PROFİL VE AKSESUARLARI

AVZ-010

Alm.Led-Avize Kasa

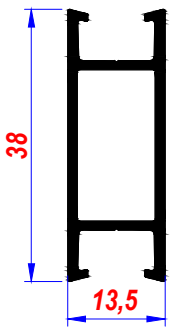

AVZ-010 P

Polikarbon Cam

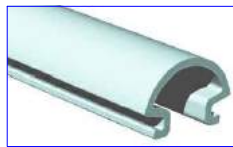

ALM.-PC.PRF. 610 cm

AVZ-010 S

Slikon Cam

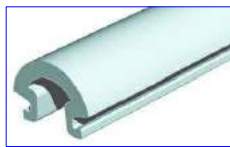

SİLİKON DİFÜZÖR 25 mt

ÇİFT YÖNLÜ DİFÜZÖR



İKİ FARKLI, MODERN LED  
AVİZE UYGULAMASI



ÇİFT YÖNLÜ DİFÜZÖR

MONTAJ 1/1

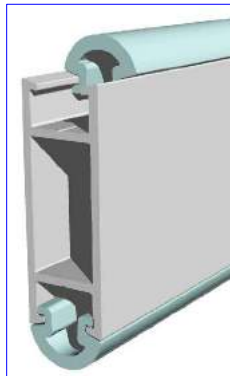
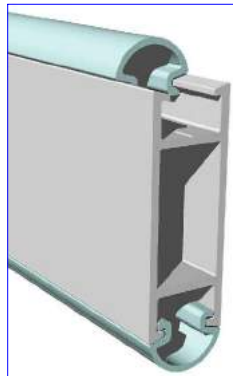
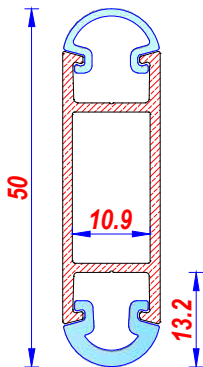

İSTENİLEN ÖLÇÜLERDE KESİM YAPILIR

All cutting dimensions can be done according to requirements

DEKORATİF ALM. LED - AVİZE PROFİL VE AKSESUARLARI

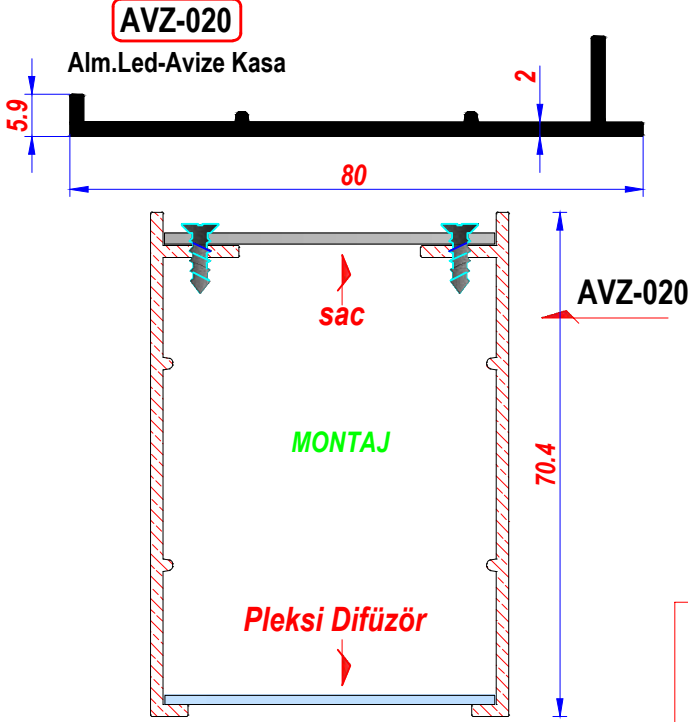

- \* Büküme uygun sertlikde, alm. profil
- \* İstenilen ölçü ve şekilde, özel üretim yapılır
- \* İstenilen ral kodlarında, renk seçeneği

P.C.- ALM.PRF. 610 cm



FARKLI, MODERN UYGULMA ÖRNEKLERİ



YENİ ALM. LED-AVİZE PROFİL VE AKSESUARLARI

YENİ **AVZ-030**



Bu üründe difüzör olarak, AVZ-001 P, AVZ-001 S ve AVZ-001 SP kullanılır

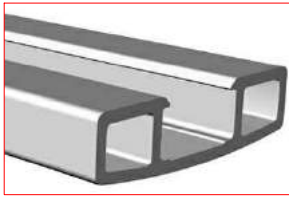

ALM. PRF. 610 cm

Büküme uygun sertlikde, alm.profil,  
3 farklı difüzör seçeneği,  
Boya ve kaplamaya uygun aksesuar  
İstenilen ral kodunda, renk seçeneği

**AVZ-001 P**

PC Cam-Difüzör

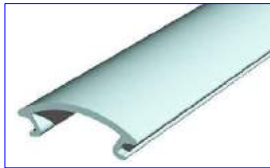

ALM.-PC.PRF. 610 cm

**AVZ-001 S**

Silikon Cam-Difüzör

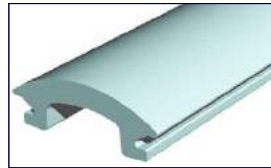

SİLİKON DİFÜZÖR 25 mt

YENİ

**AVZ-001 SP**

Modifiye Silikon



16 lık  
EKONOMİK YENİ ÜRÜN

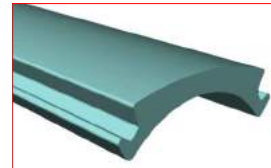

MODİFİYE DİFÜZÖR 25 mt

YENİ **AVZ-030 DY**  
Pls.Ayıp Örten Aparatı



2 Vidalı Aparat

YENİ **AVZ-030 T**  
Pls. Kenar Tapa



Ürün Sonlandırma Tapası

YENİ **AVZ-030 TN**  
Pls. Askı Aparatı



Üstten Nipelli

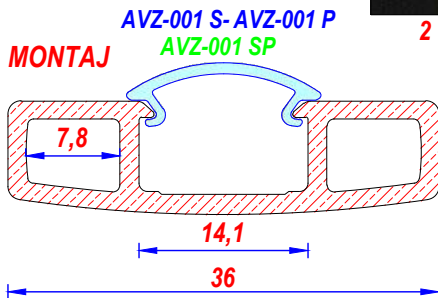

Aksesuarların tamamı, boya ve kaplamaya uygun üretilmiştir

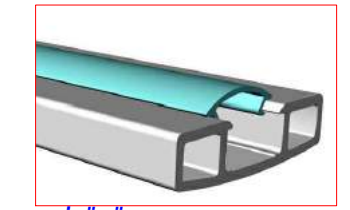

PC. DİFÜZÖR ve ALM. PRF. 610 cm

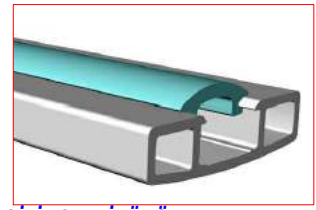

SİLİKON DİFÜZÖR ve ALM. PRF.

İÇ MEKAN, LEDLİ SÜPÜRGELİK PROFİL VE AKSESUARLARI

**YA-090**  
Alm.Ledli  
Süpürgelik Kasası

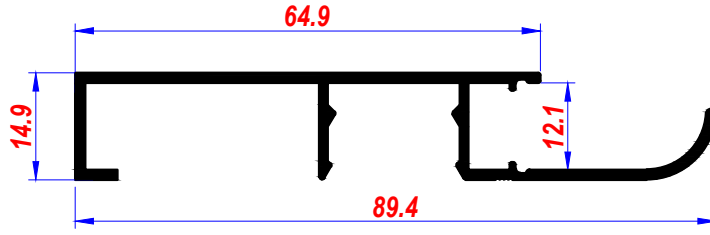

**YA-002 A**  
PC. Difüzör



**YA-090 A**  
PVC U Duv. Montaj Prf.

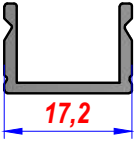

**YA-090** PVC PRF.300 cm

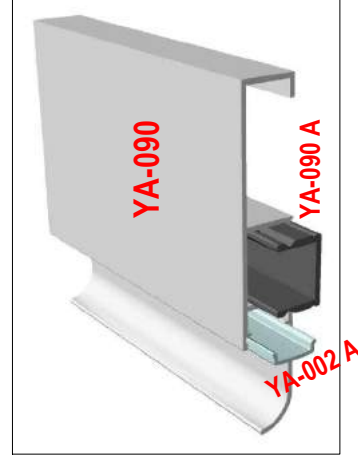

PC.DİFÜZÖR-ALM.PRF. 610 cm

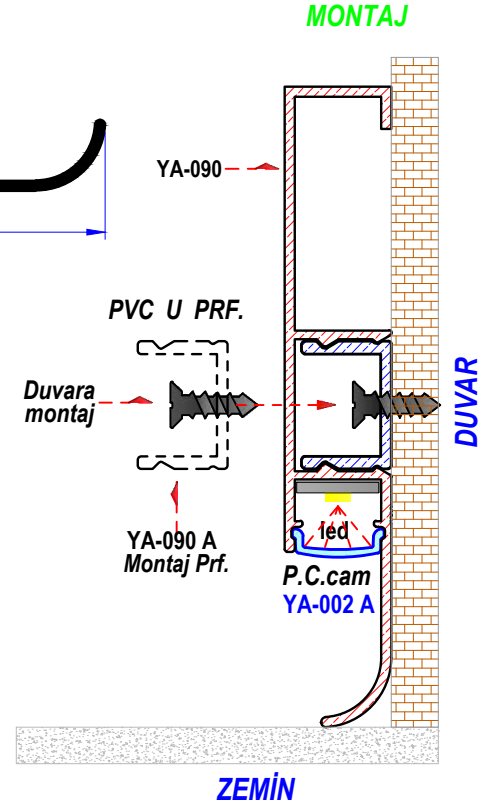

İÇ MEKAN, LEDLİ SÜPÜRGELİK PROFİL VE AKSESUARLARI

**YA-091**  
Alm.Ledli Süpürgelik Kasası

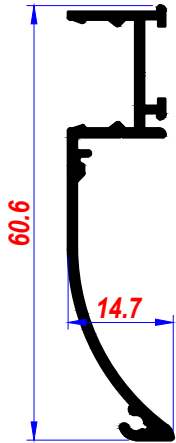

**YA-091**



ALM. PRF. 610 cm

**YA-091 A**  
Alm. Prf.

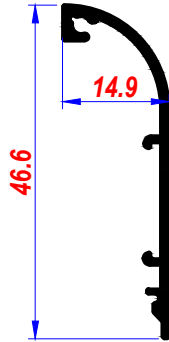

**YA-091 A**



ALM. PRF. 610 cm

**YA-023 B**  
Alm.Montaj Prf.

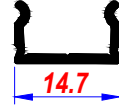

**YA-019 C**  
PC. Difüzör



**MONTAJ**

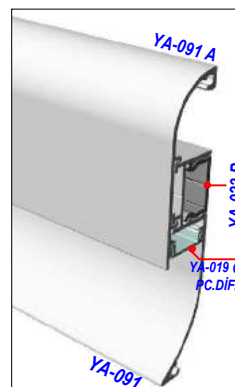

**MONTAJ 1/1**

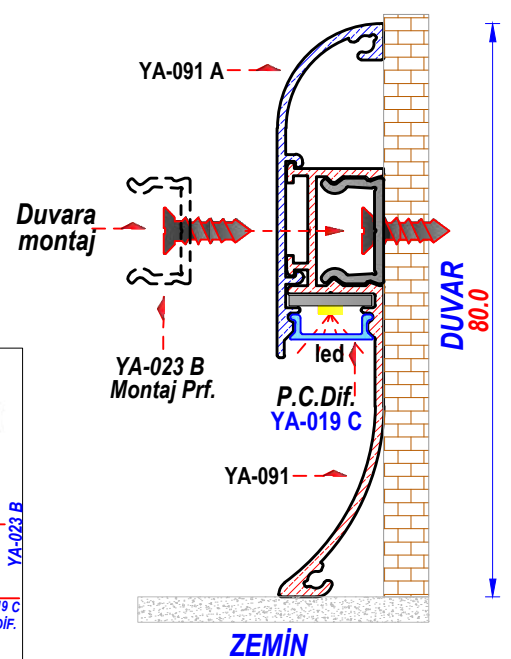

İSTENİLEN ÖLÇÜLERDE KESİM YAPILIR  
All cutting dimensions can be done according to requirements

LEDLİ SÜPÜRGELİK VE BAZA PROFİLİ

YA-092  
Alm.Ledli  
Süpürgelik-Baza  
Profili

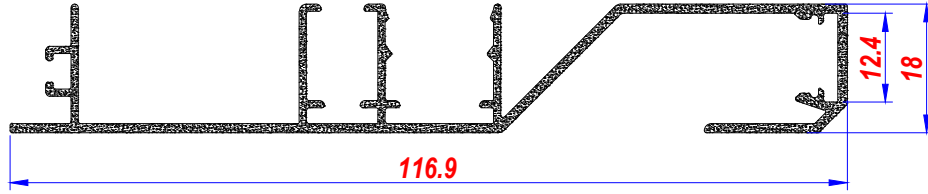

Bu ürün, Ledli süpürgelik ve ledli baza olarak kullanılabilir

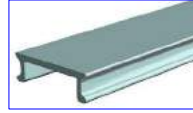

YA-019 C  
PC.Cam-Difüzör



BZ-001  
Pls.Baza Klipsi



YA-023 B  
Alm.Montaj Prf.

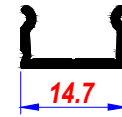

BF-101  
Alm.Montaj Prf.



MD-445  
Alm.Köşe Dönüş Prf.



DIŞ KÖŞE



İÇ KÖŞE

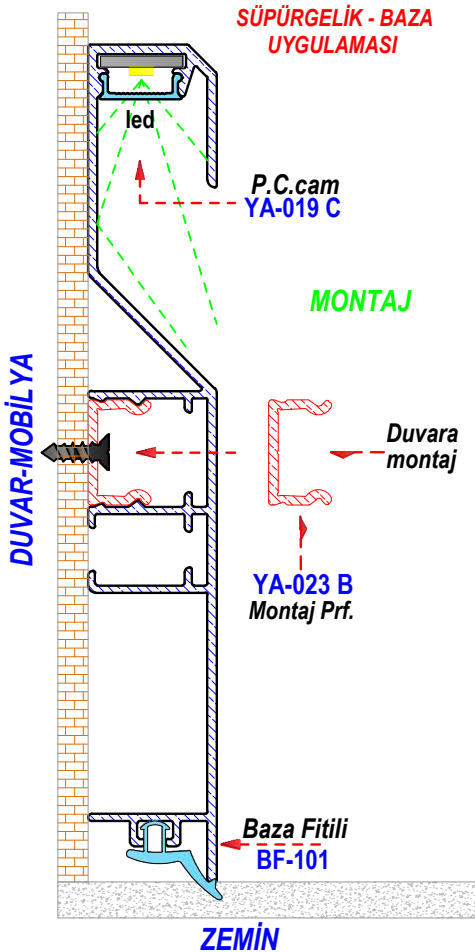

YA-092 YA-019 C

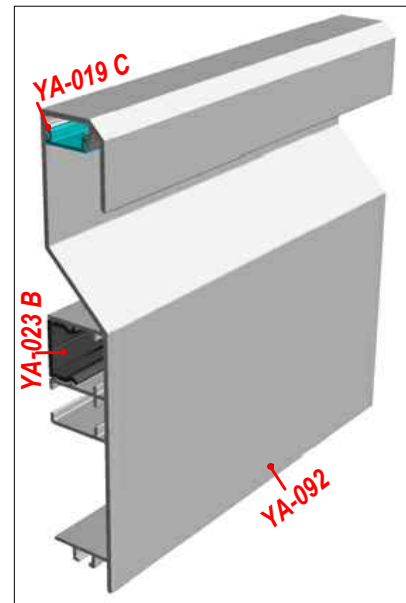

ALM.PRF. - PC. PRF 610 mm

İSTENİLEN ÖLÇÜLERDE KESİM YAPILIR  
All cutting dimensions can be done according to requirements

AKVARYUM ADINLATMA PROFİLLERİ

YENİ YA-AK 01

Alm. Akvaryum Prf.

KÜÇÜK

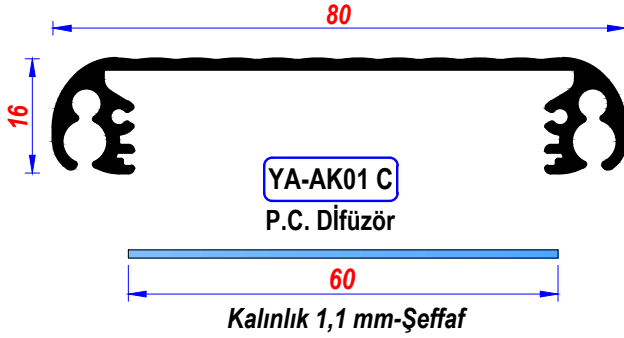

YA-AK01 T

Kenar Tapa



YA-AK01 A

Metal Ayak

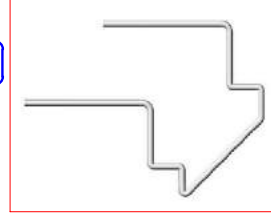

YA-AK 01 ALM.PRF.

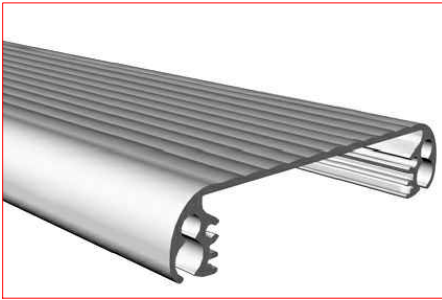

ALM.PRF. 610 mm

AKVARYUM AYDINLATMA



YA-AK01 C PC.PRF.

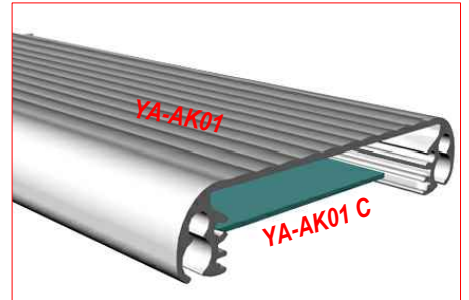

ALM.PRF. - PC. PRF 610 mm

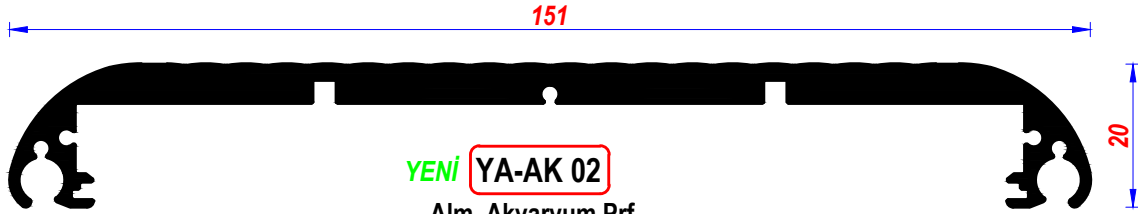

YENİ YA-AK 02

Alm. Akvaryum Prf.

BÜYÜK

YA-AK02 C

P.C. Dİfüzör

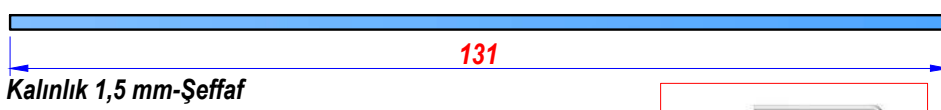

YA-AK02 T

Kenar Tapa  
Alm.Lazer



YA-AK02 A

Metal Ayak

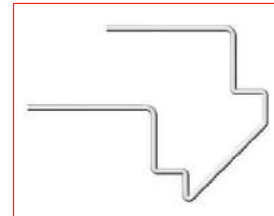

YA-AK 02 ALM.PRF.

ALM.PRF. - PC. PRF 610 mm

YA-AK02 C PC.PRF.

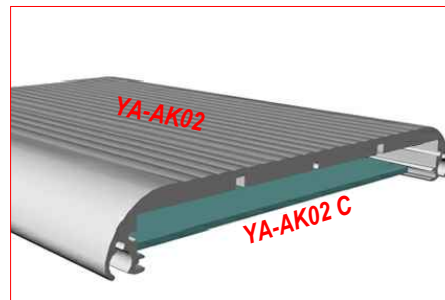

All cutting dimensions can be done according to requirements

## LIGHT BOX PROFİLİ

YENİ

YA-LB 01

Light Box Profili

45 mm lik

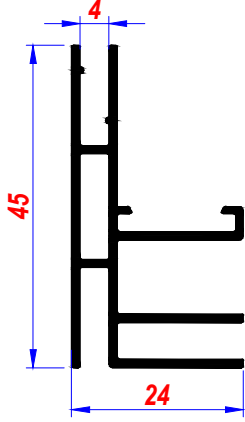

Sökülüp takılabilen özel baskılı vinil bez sayesinde, reklam değiştiğinde kasa değişmez  
İşçiliği daha kolay, aydınlatması daha iyi olan, yeni ekonomik alüminyum profil...

YA-LB 01

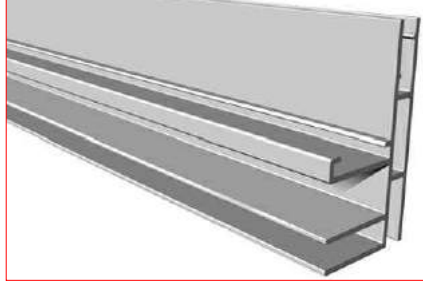

ALÜMİNYUM PRF. 610 cm

MONTAJ

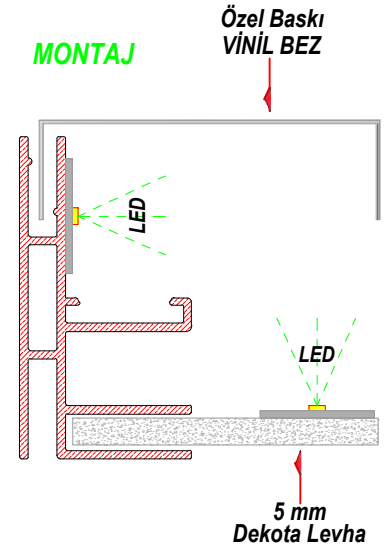

3 FARKLI LIGHT BOX UYGULAMASI



YENİ YA-MK 01

Ledli Alm.Korkuluk Prf.

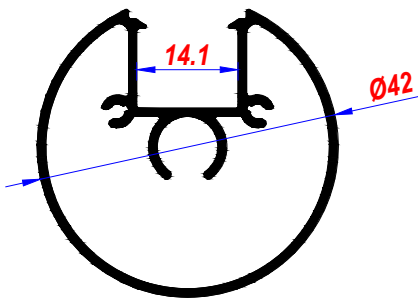

## KORKULUK PROFİLİ

AVZ-001 P

PC Cam-Difüzör

16,2

Opal

ALÜMİNYUM KORKULUK PROFİLİ,  
Yuvarlak ledli lineer sarkıt aydınlatma,  
ve Mobilyalarda ledli ayak olarak da  
kullanıma uygundur...

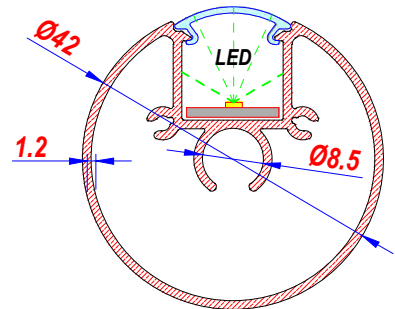

MERDİVEN KORKULUK UYGULAMASI



2 FARKLI LİNEER SARKIT UYGULAMASI



İSTENİLEN ÖLÇÜLERDE KESİM YAPILIR  
All cutting dimensions can be done according to requirements

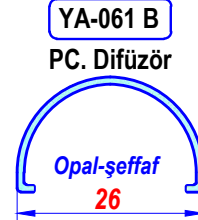
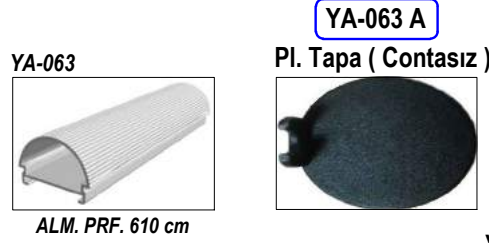
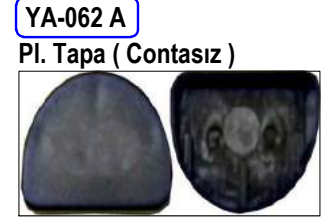
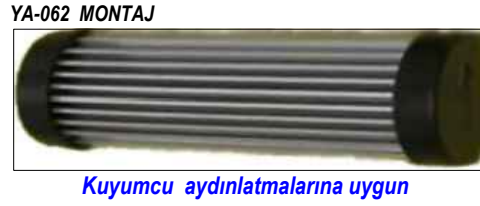
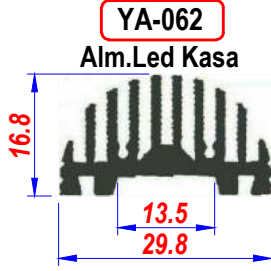
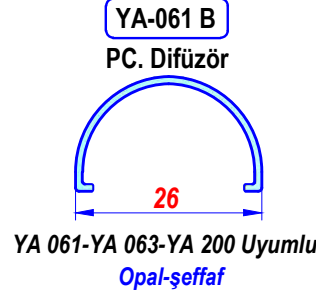
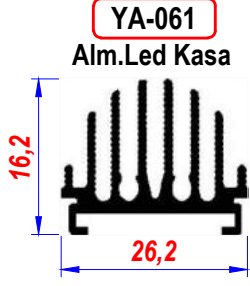

YA 061-YA 063-YA 200 Uyumlu

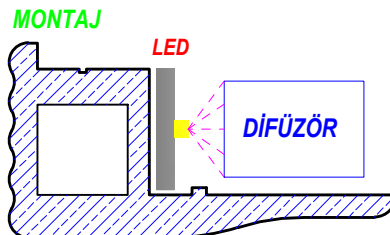
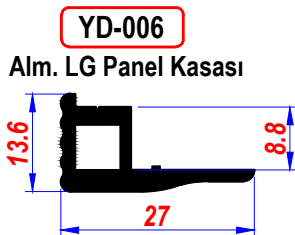
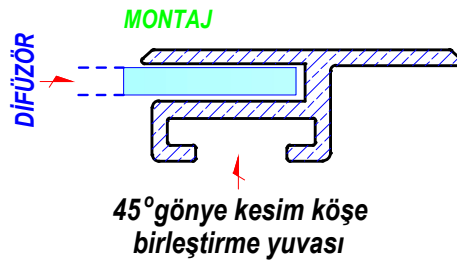
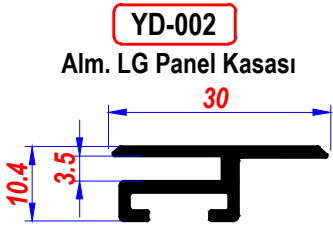
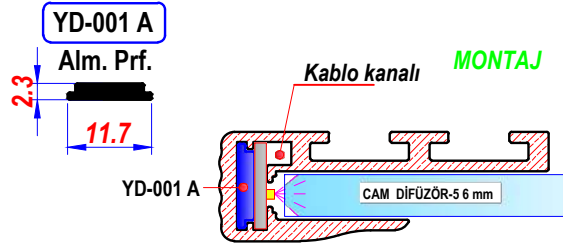

İSTENİLEN ÖLÇÜLERDE KESİM YAPILIR  
All cutting dimensions can be done according to requirements

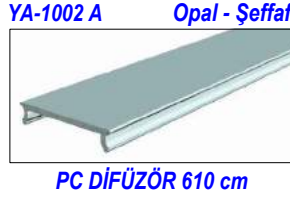
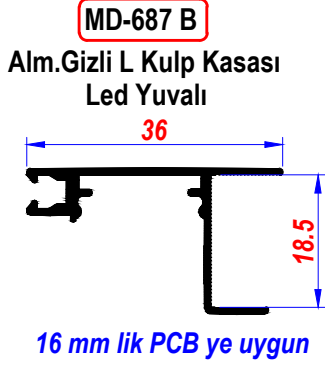

Hem gizli kulp, hemde ledli aydınlatma görevi görür

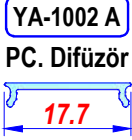
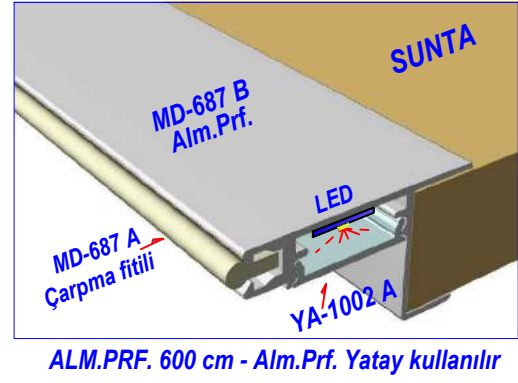

- \* Mutfaklarda, tezgah üstü, tezgah duvarı, tezgah altı (baza) aydınlatmalarında,
- \* Otel dekorasyonunda, yatak başı ve yarım lambiri aydınlatmalarında,
- \* Otel dekorasyonunda, yatak başı ve yarım lambiri aydınlatmalarında
- \* 18 mm suntaya geçme sistemi ile kolay montaj yapılabilir.

**TEZGAH ÜSTÜ DOLABI BÜYÜTÜLMÜŞ DETAY**

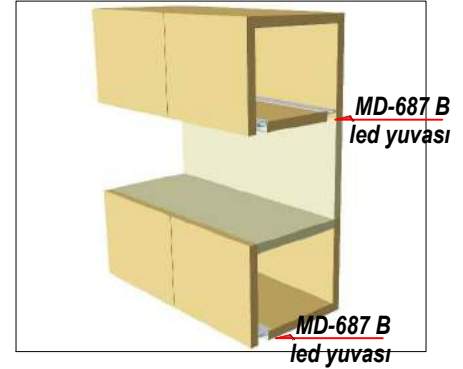
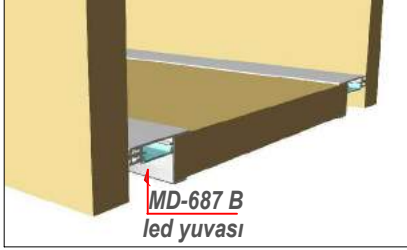

**MONTAJ YAN KESİT**

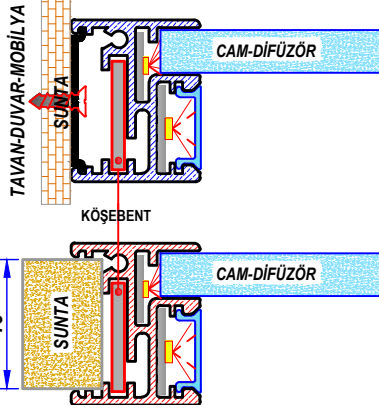
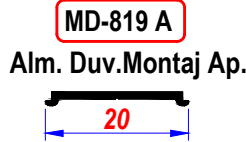
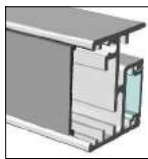
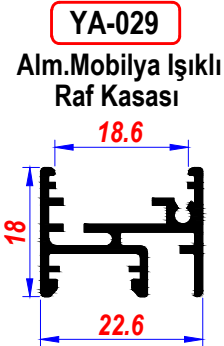
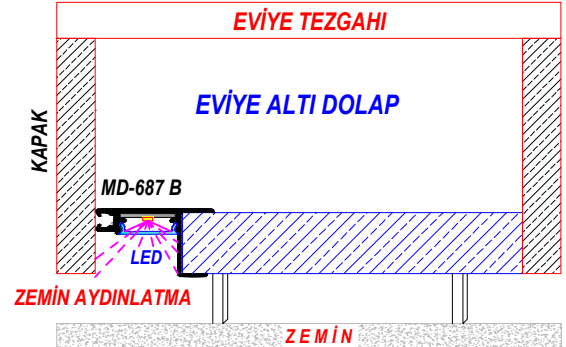
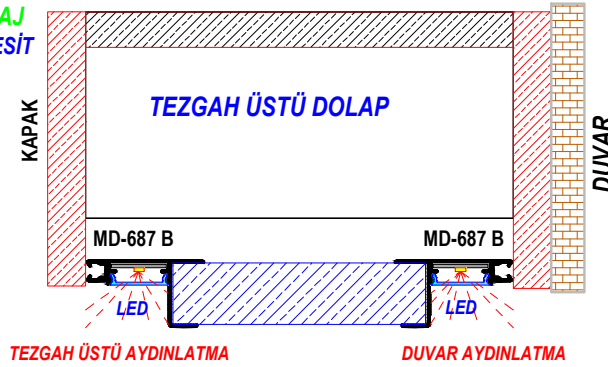

**DOLAP İÇİ LEDLİ RAF**  
**LEDLİ SARKIT ÇERÇEVE**

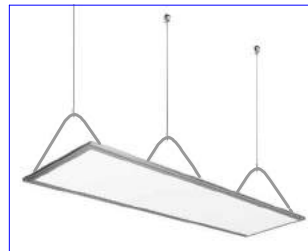

**Dolap içi ledli raf,**  
**Lineer slim sarkıt,**  
**Aıtlı üstlü,2 difüzörlü,**  
**duvar tipi ledli raf.**  
**Ledli ayna çerçevesi,**  
**Ledli çerçeve**



**DUVAR TİPİ LEDLİ RAF**

**İSTENİLEN ÖLÇÜLERDE KESİM YAPILIR**  
 All cutting dimensions can be done according to requirements

DIŐ MEKAN IP 66 ya, UYGUN ÇİZGİSEL AYDINLATMA PRF-AKSESUARLARI

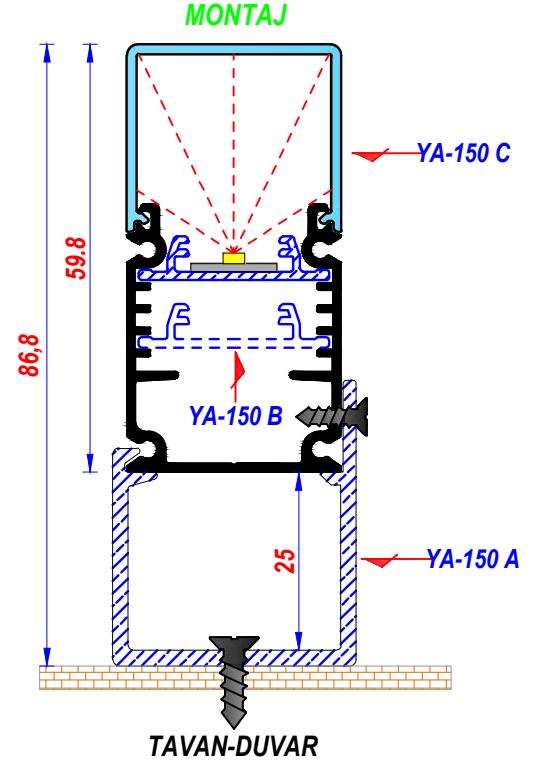
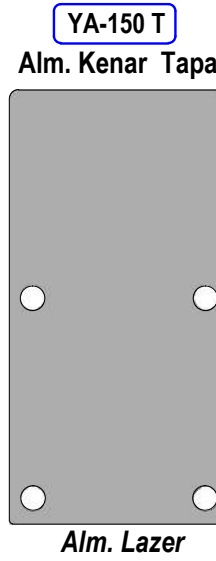
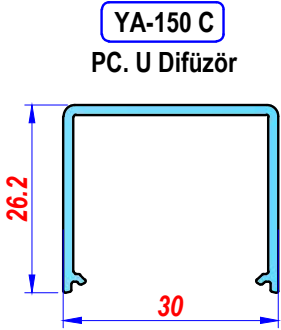
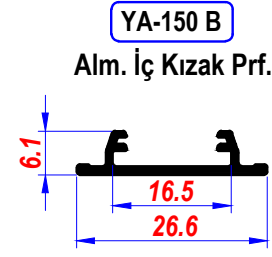
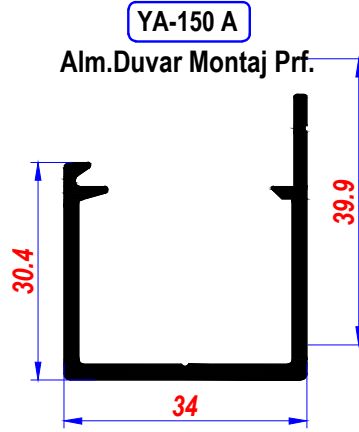
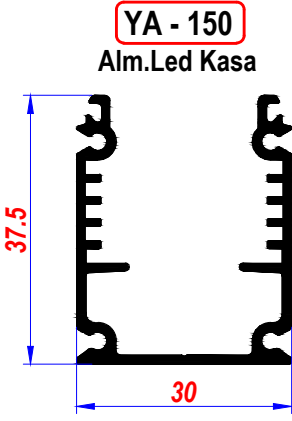

**MONTAJ**



PC.DİFÜZÖR-ALM.PRF. 610 cm

**Yazılım kumandalı, temalı aydınlatma sistemlerine uygun  
Programlanabilir, şov amaçlı cephe aydınlatmaları.  
Enerji kablosu ve kumanda modülüne uygun,  
duvar montaj prf.**

**DIŐ MEKAN ÇİZGİSEL AYDINLATMA UYGULAMASI**



YA-150, YA-201, YA-202, YA-203, YA-204 ÜRÜNLER, IP 66 ya UYGUNDUR

**İSTENİLEN ÖLÇÜLERDE KESİM YAPILIR**  
All cutting dimensions can be done according to requirements

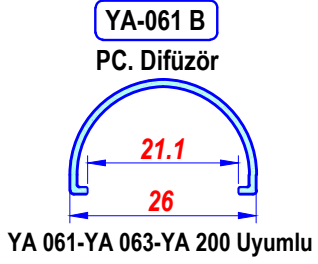
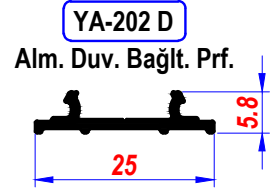
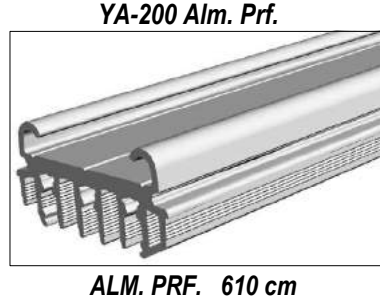
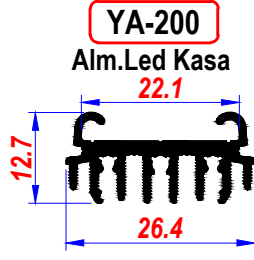

**Benzerlerinden daha fazla fonksiyonel**  
**Üç farklı cam seçeneği**  
**Üç farklı lazer kenar tapa seçeneği**  
**Soğutma kapasitesi yüksek, ekonomik ürün**

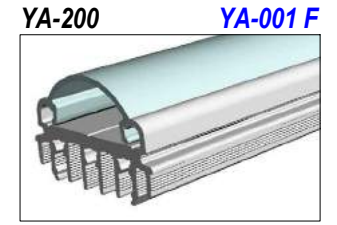
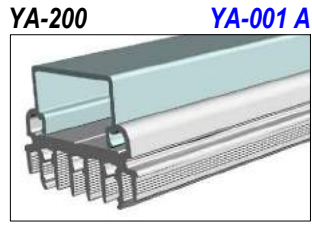
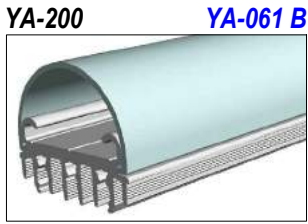
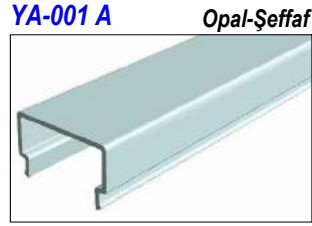
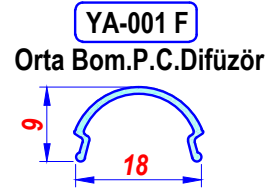
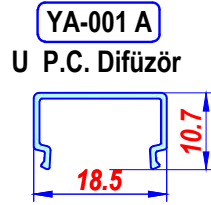

ALM.PRF. - PC. DİF. 610 cm

ALM.PRF. - PC.DİF. 610 cm

ALM.PRF. - PC.DİF. 610 cm



**ALM.PRF. - PC. CAM UYGULAMA**  
**YA-061 B, YA-001 A, YA-001 F**

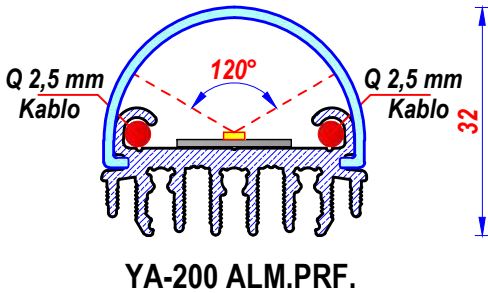

**YA-200 ALM.PRF. VE AKSESUARLARI**

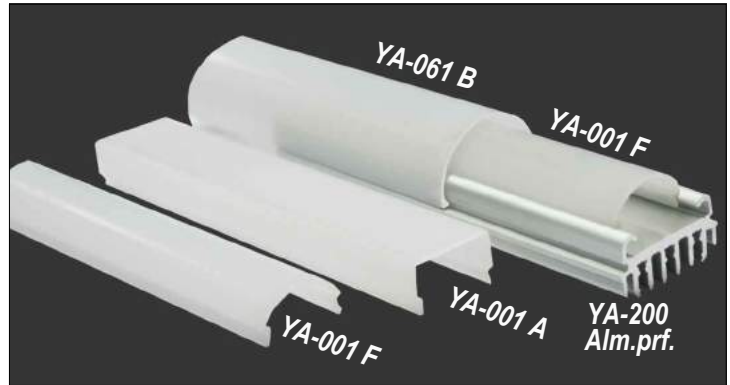

**İSTENİLEN ÖLÇÜLERDE KESİM YAPILIR**  
All cutting dimensions can be done according to requirements

YA-201

Alm.Led Kasa

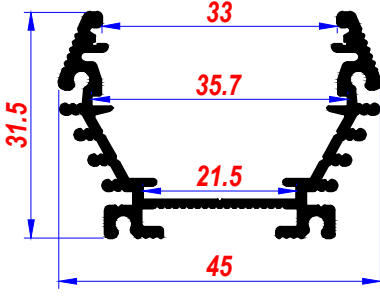

YA-201 C

P.C. Difüzör

Düşük Bombeli-Çizgili

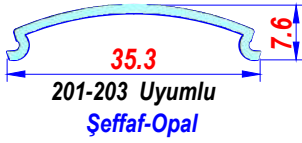

201-203 Uyumlu  
Şeffaf-Opal

YA-201 C



P.C.DİFÜZÖR 610 cm

YA-201 A

P.C.Ken.Tapa-Conta  
Düşük Bombeli



YA-201 A1

P.C.Ken.Tapa-Conta  
Düşük Bombeli



KULAKLI

MONTAJ YA-201 C

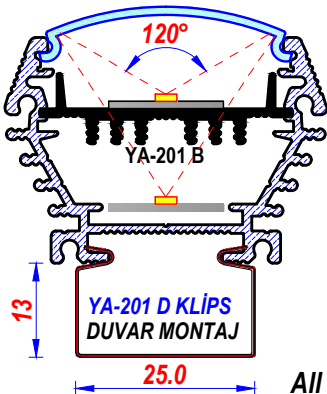

YA-201 D KLİPS  
DUVAR MONTAJ

YA-201 YA-201 D INOKS KLİPS

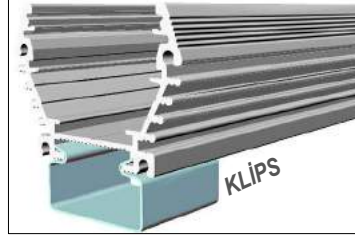

Benzerlerinden daha fazla fonksiyonel  
İki farklı cam ve iç kızak  
Dört farklı kenar tapa seçeneği  
Soğutma kapasitesi yüksek, ekonomik ürün

YA-201 C1

P.C. Difüzör  
Yüksek Bombeli



YA-201 C1



P.C.DİFÜZÖR 610 cm

YA-201 E

P.C.Ken.Tapa-Conta  
Yüksek Bombeli



YA-201 E1

P.C.Ken.Tapa-Conta  
Yüksek Bombeli



KULAKLI

ALM. PRF. VE PC. DİFÜZÖR UYGULAMALARI

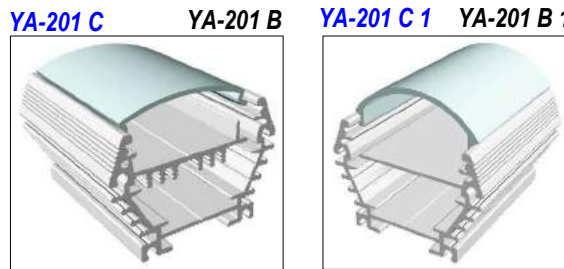

PC.DİFÜZÖR-ALM.PRF. 610 cm

İSTENİLEN ÖLÇÜLERDE KESİM YAPILIR

All cutting dimensions can be done according to requirements

YA-202 D

Alm. Duv. Bağlt. Prf.



ALM.PRF. 610 cm

YA-201 D

Duvar Bağlt.Aprt.



Paslanmaz Klips H=12,5mm

YA-201 B

Alm. Kızak Prf.

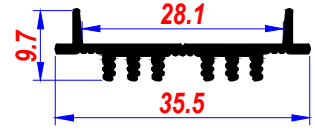

201-203 Uyumlu

YA-201 B1

Alm. Kızak Prf.



YA-252 K

Alm. Kızak Prf.



MONTAJ YA 201 YA 201 C



YA 253 M Dekoratif minik ayak  
Kasa 180° hareket ettirilebilir

YA-201 ALM.PRF. VE AKSESUARLARI

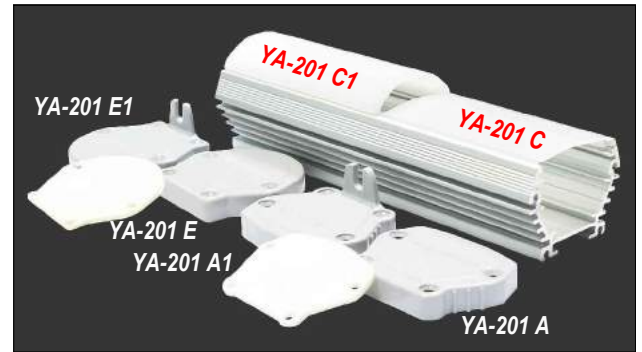

Alm.Prf.in Alt tırnağına ayak seti (YA 253 serisi) montaj  
edilerek, açılı kullanabilme imkanı

MONTAJ

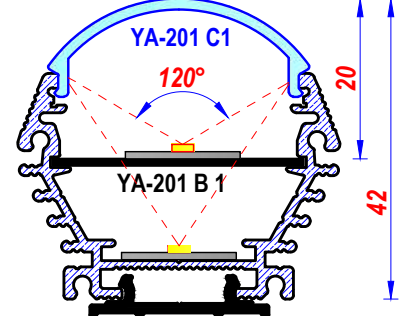

YA-202 D Duv.Bağlt.  
YA 201 C - YA 201 B  
P.C.-Kızak uygulaması

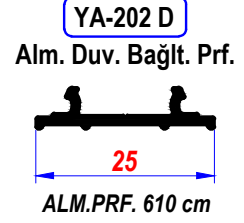
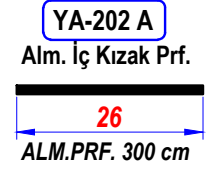
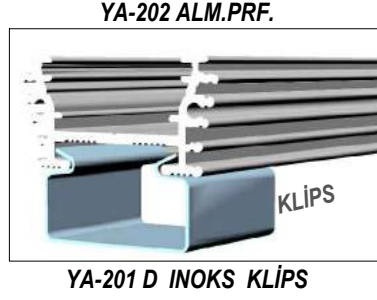
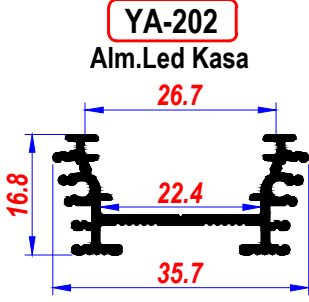

Yeni YA-202 Kalıbı Yenilendi  
IP 65 e Uygun, İç - Dış Mekan Yeni Ürün

Tek-İki sıra led uygulanabilir  
IP 65 Uygun, İç-Dış Mekan Ürün.  
Gerektiğinde Sarkıt olarak da Uygulanır  
Soğutma Kapasitesi yüksek,  
Dört farklı P.C.Difüzör seçeneği

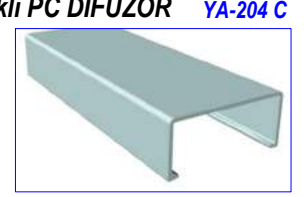
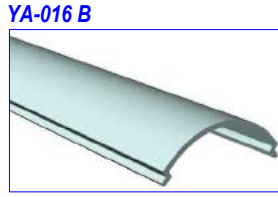
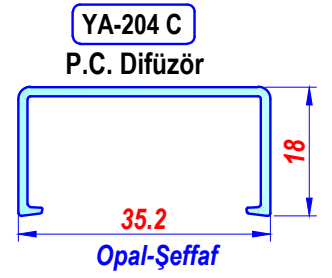
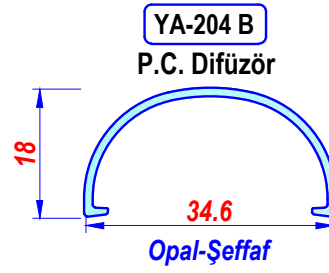
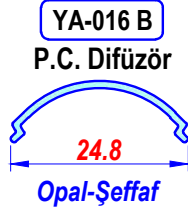
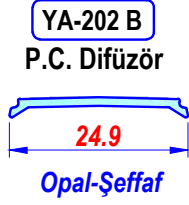

PC.DİFÜZÖR-ALM.PROF. 610 cm

PC.DİFÜZÖR-ALM.PROF. 610 cm

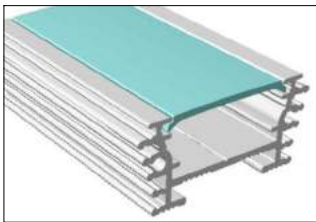

YA-202 B YA-202 ALM.PROF.

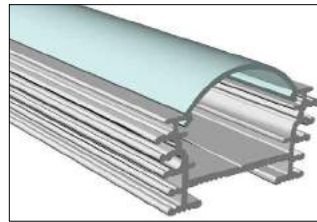

YA-016 B YA-202 ALM.PROF.

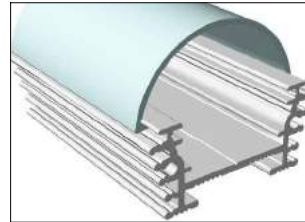

YA-204 B YA-202 ALM.PROF.

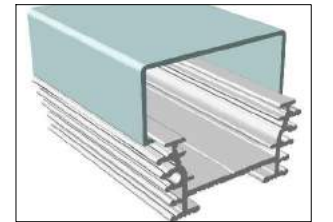

YA-204 C YA-202 ALM.PROF.

### MONTAJ

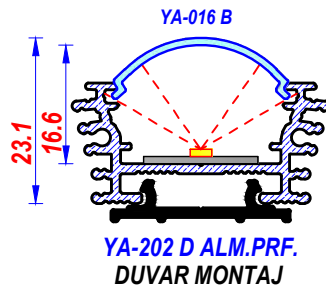
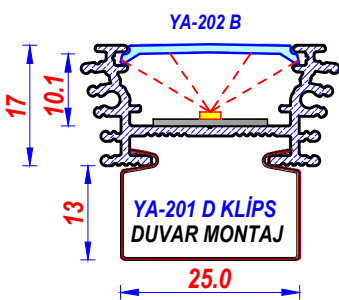

### MONTAJ

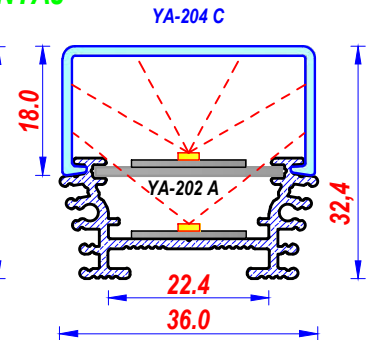
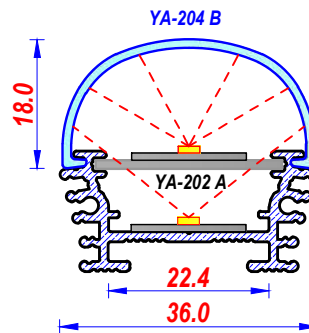

KENAR TAPALAR, ARKA SAYFADA

İSTENİLEN ÖLÇÜLERDE KESİM YAPILIR  
All cutting dimensions can be done according to requirements

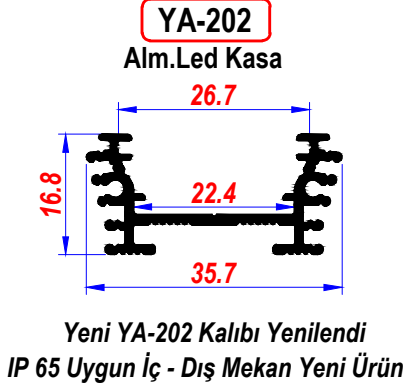

**Tek-iki sıra led uygulanabilir**  
**IP 65 Uygun, İç-Dış Mekan Ürün**  
**Sarkıt olarak kullanıma uygun aksesuarlar**  
**Soğutma Kapasitesi yüksek,**  
**Dört farklı P.C.difüzör seçenekleri**  
**Alt tırnağına ayak seti (YA 253 serisi) montaj**  
**edilerek, açılı kullanabilme imkanı**

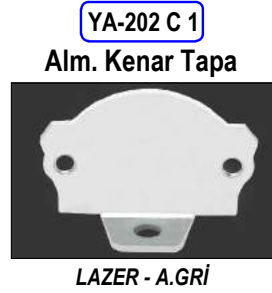
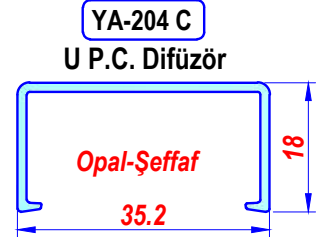
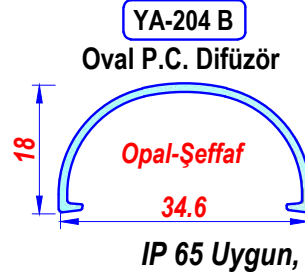
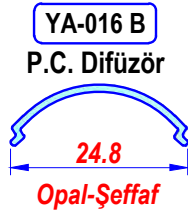

**YA-202 ALM. LED KASA VE AKSESUARLARI**

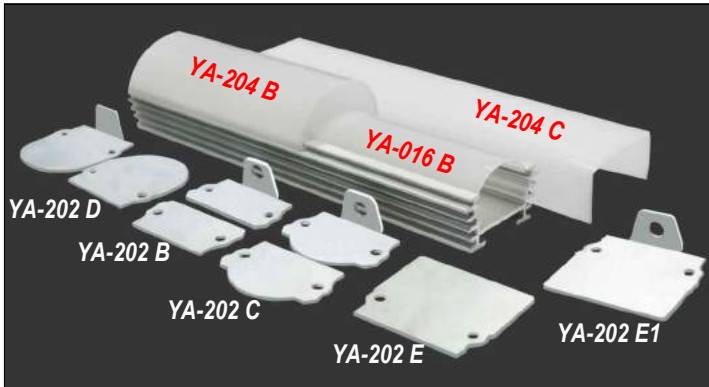

**YENİ PLS. KEN. TAPALAR, YAKINDA SATIŞA SUNULACAKTIR**

**DIŞ MEKAN MİMARİ AYDINLATMA UYGULAMASI**



**YA-202 ve AKSESUARLARI, IP 66 ya UYGUNDUR**

**İSTENİLEN ÖLÇÜLERDE KESİM YAPILIR**  
All cutting dimensions can be done according to requirements

YA-203

Alm.Led Kasa

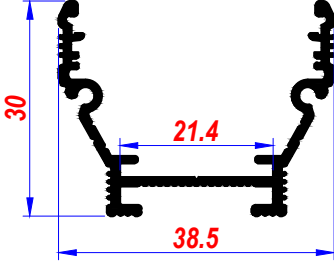

YA-203

YA-201 D INOKS KLİPS

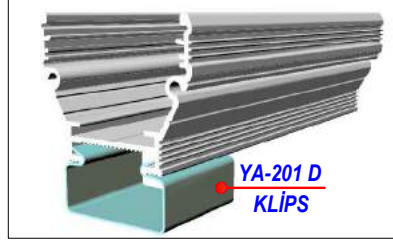

Benzerlerinden daha fazla fonksiyonel  
İki farklı cam ve iç kızak  
Dört farklı kenar tapa seçeneği  
Ekonomik ürün

YA-201 B

Alm. Kızak Prf.

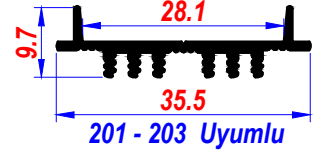

YA-201 B1

Alm. Kızak Prf.



YA-252 K

Alm. Kızak Prf.

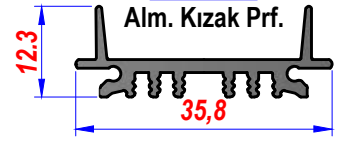

YA-201 C

P.C. Difüzör

Düşük Bombeli-Çizgili



YA-201 C



P.C.DİFÜZÖR 610 cm

YA-201 C1

P.C. Difüzör

Yüksek Bombeli



YA-201 C1



P.C.DİFÜZÖR 610 cm

YA-202 D

Alm. Duv. Bağlt. Prf.



YA-201 D

Duvar Bağlt.Aprt.

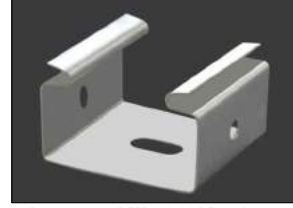

Paslanmaz Klips - H=12,5mm

MONTAJ YA 203 YA 201 C 1



YA 253 M Dekoratif minik ayak

YA-203 A

P.C.Ken.Tapa-Conta

Düşük Bombeli



RENK:Açık Gri  
IP 66 TAPA

YA-203 B

P.C.Ken.Tapa-Conta

Yüksek Bombeli



YA-203 A1

P.C.Ken.Tapa-Conta

Düşük Bombeli



RENK:Açık Gri  
IP 66 TAPA

YA-203 B1

P.C.Ken.Tapa-Conta

Yüksek Bombeli



### YA-203 ALM.LED KASA VE AKSESUARLARI

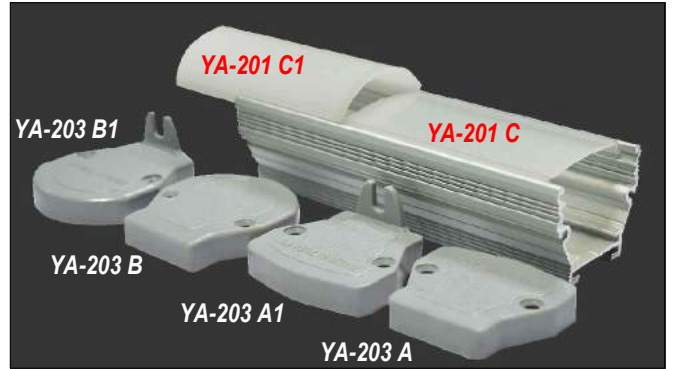

Alm.Prf.in Alt tırnağına ayak seti (YA 253 serisi) montaj edilerek, açılı kullanabilme imkanı

### ALM. PRF. ve PC. CAM UYGULAMALARI

YA-201 C

YA-201 B1

YA-201 C 1

YA-201 B

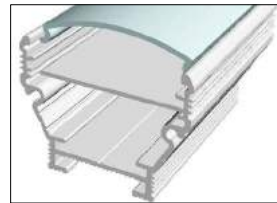

YA-201 C MONTAJ

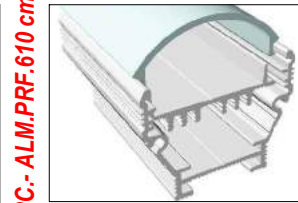

YA-201 C1 MONTAJ

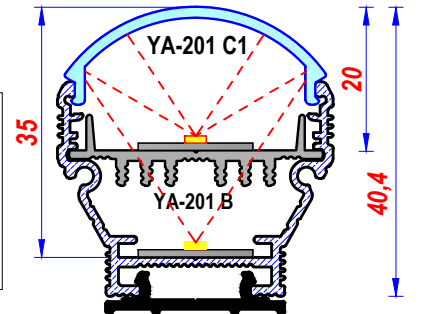

YA-202 D Duv.Bağlt.

YA 201 C - YA 201 B1

Cam-Kızak uygulaması

İSTENİLEN ÖLÇÜLERDE KESİM YAPILIR

All cutting dimensions can be done according to requirements

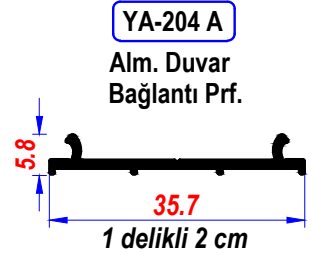
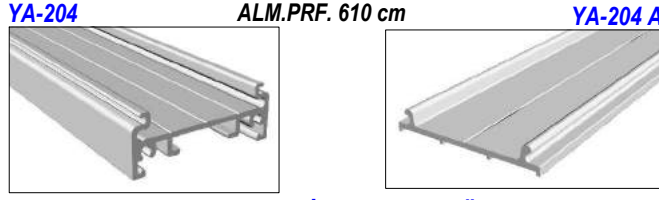
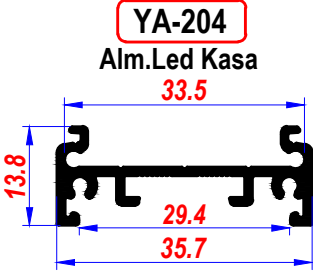

**IP 66 Uygun, İç-Dış Mekan Ürün**  
Gerektiğinde Sarkıt olarak da uygulanabilir  
İki farklı P.C.Difüzör, dörder farklı IP 66 tapa seçenekleri  
Tek-iki sıra led uygulanabilir

**EKONOMİK UYGULAMA**

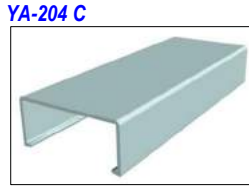
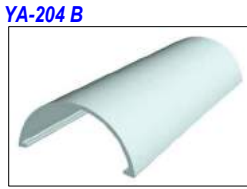
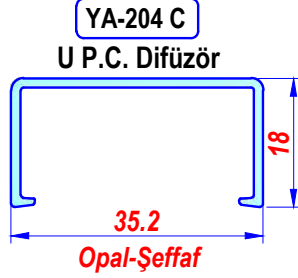
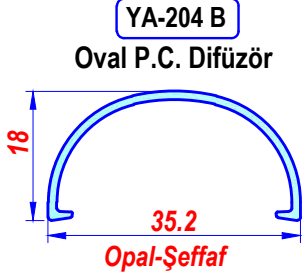

**PC.DİFÜZÖR-ALM.PROF. 610 cm**



**YA-204 ALM. KASA VE AKSESUARLARI**

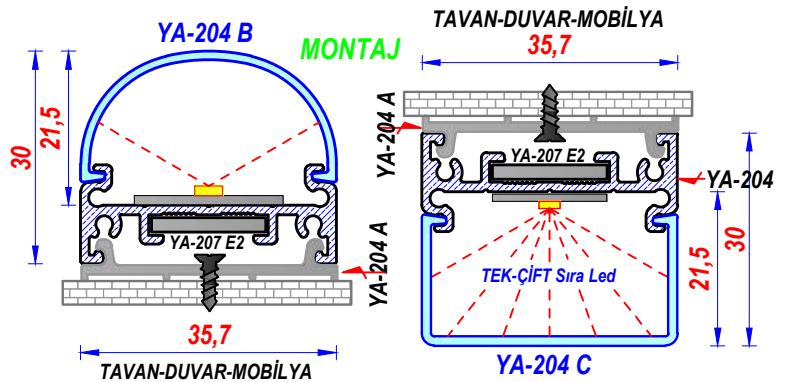
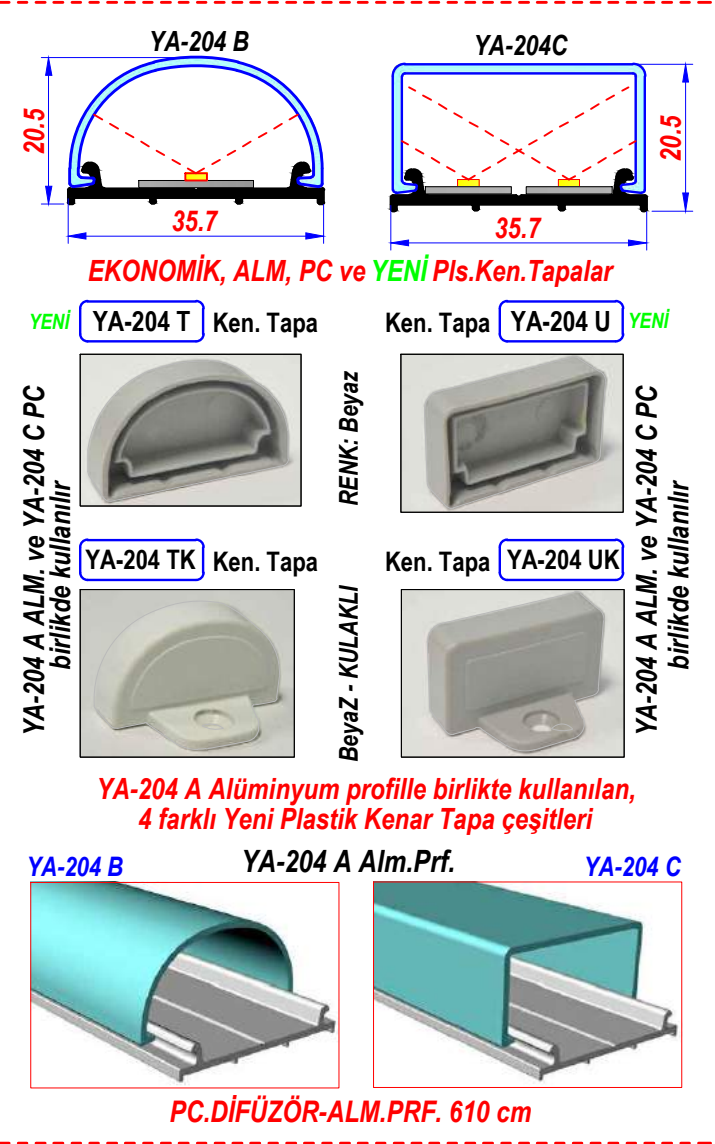

**İSTENİLEN ÖLÇÜLERDE KESİM YAPILIR**

IP 66, İÇ-DİŞ MEKAN ÇİZGİSEL AYDINLATMA

YA-205

Alm.Led Kasa

IP 66

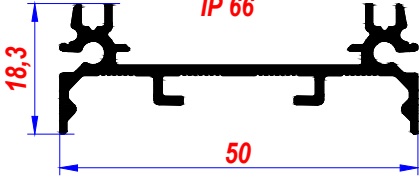

ALM.-PC.PRF. 610 cm

YA-205 C

PC.Cam-Difüzör

YA-205 C

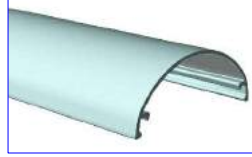

ALM.-PC.PRF. 610 cm

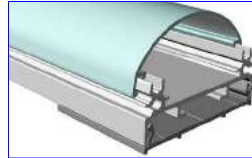

YA-205 YA-205 A

YA-205 U

PC.Cam-U Difüzör

YA-205 U

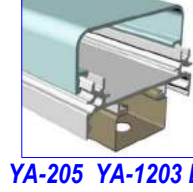

YA-205 YA-1203 D

YA-205 D

Alm.Duv.Bğt.Prfl.

50

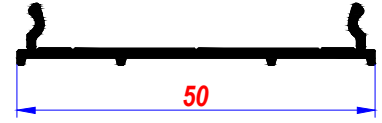

YA-254 C

Elastron fitil



PC.Difüzör Fitili

YENİ YA-205 C1

Ken.Tapa-Conta



Plastik A.Gri

YENİ YA-205 CK

Kulaklı Ken.Tapa-Conta

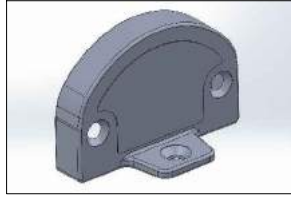

Plastik A.Gri-KULAKLI

YA-205 U1 YENİ

Ken.Tapa-Conta

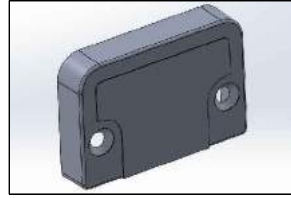

Plastik A.Gri

YA-205 UK YENİ

Kulaklı Ken.Tapa-Conta

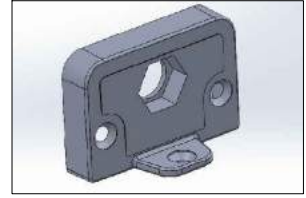

Plastik A.Gri-KULAKLI

YA-201 D

Duvar Bağlt.Aprt.

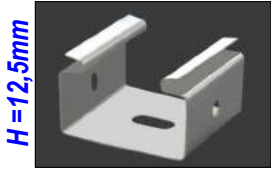

H = 12,5mm

PASLANMAZ KLİPS - ÇELİK

YA-1203 D

Duvar Bağlt. Aprt.

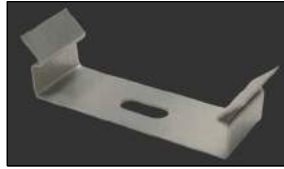

Alüminyum gövde de kullanılan, üç farklı duvar bağlantısı. YA-203 D, 8 mm lik TTR kabloya uygundur.

Benzerlerinden daha fazla fonksiyonel, İki farklı difüzör, üç duvar bağlantı aparatı, Dört farklı plastik kenar tapaları olan, PC cam fitili ile sızdırmazlık sağlayan, ekonomik ve dekoratif IP 66, ürün...

MONTAJ

ÜRÜNLER, İÇ-DİŞ MEKAN, LİNEER SARKIT OLARAK. YADA TAVANA DİREK MONTAJ EDİLEREK KULLANILIR

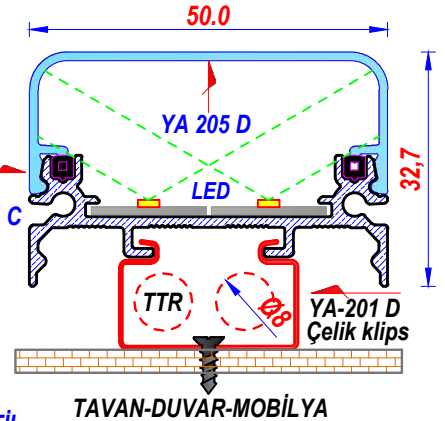
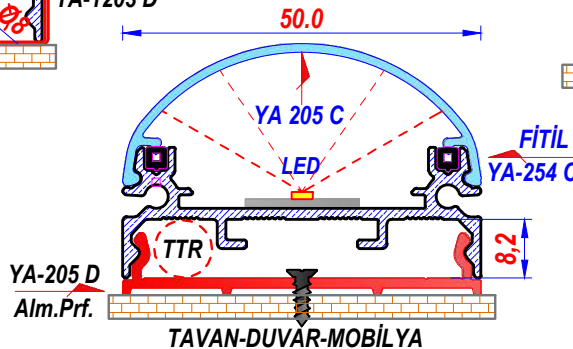
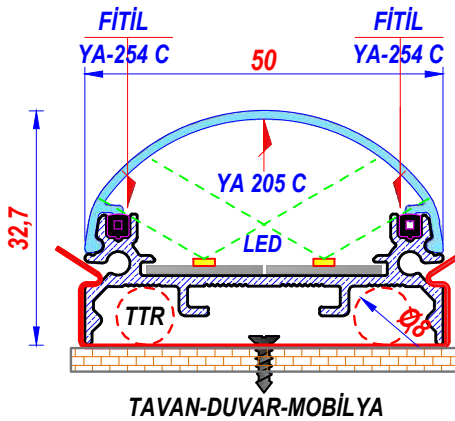

İSTENİLEN ÖLÇÜLERDE KESİM YAPILIR

All cutting dimensions can be done according to requirements

YÜKSEK TAVAN IP 65 ALM. LED PROFİL VE AKSESUARLARI

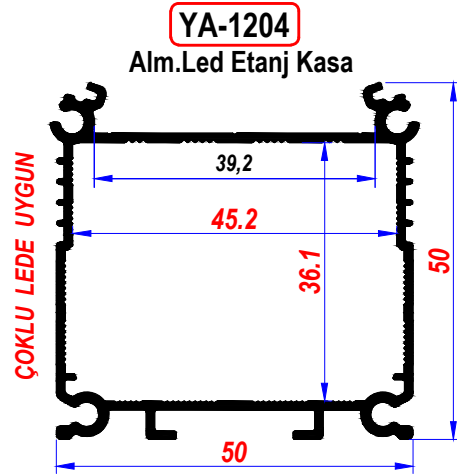
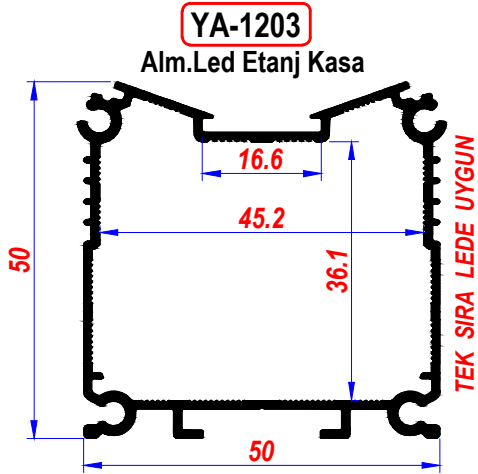

AKSESUARLAR, HER İKİ ÜRÜNE de UYGUNDUR

YA-1203 D

Duvar Bağlt. Aprt.



PASLANMAZ KLİPS - ÇELİK

YA-1203 C

PC Cam-Difüzör

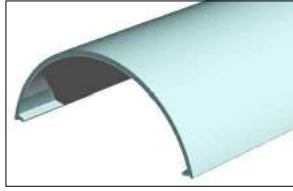

UZUNLUK 610 cm

YA-201 D

Duvar Bağlt. Aprt.

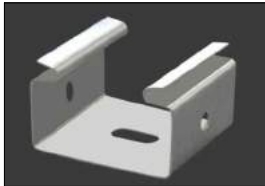

Paslanmaz Klips - H =12,5mm  
İçten Kavramalı, sağlam klips

YA-207 D

Tavan Askı Aparatı



Tekli-Krom - tel 1,5 mt  
özel tel ölçüsü, sipariş edilir

Otopark - Yüksek tavan aydınlatma  
Benzerlerinden, daha ekonomik ürün  
IP 65 e Uygun, İç-Dış Mekan Ürün  
Geniş driver alanı; 36,1 x 45,2 mm  
( Acil aydınlatma kitine uygun )

Paslanmaz 2 farklı klipsle, kolay tavan  
montajı

Sarkıt olarak kullanıma uygun aksesuarlar  
Alt tırnağa, ayak seti (YA 253 serisi)  
montaj edilerek, açılı kullanabilme imkanı

YA-1203 T

Pls.Ken.Tapa-Conta



Faturalı Conta

MONTAJ

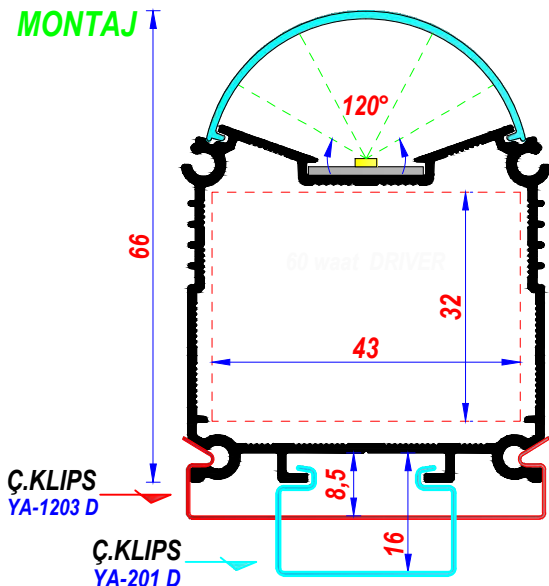

YA-1203 ALM.PROF. VE AKSESUARLARI



İSTENİLEN ÖLÇÜLERDE KESİM YAPILIR  
All cutting dimensions can be done according to requirements

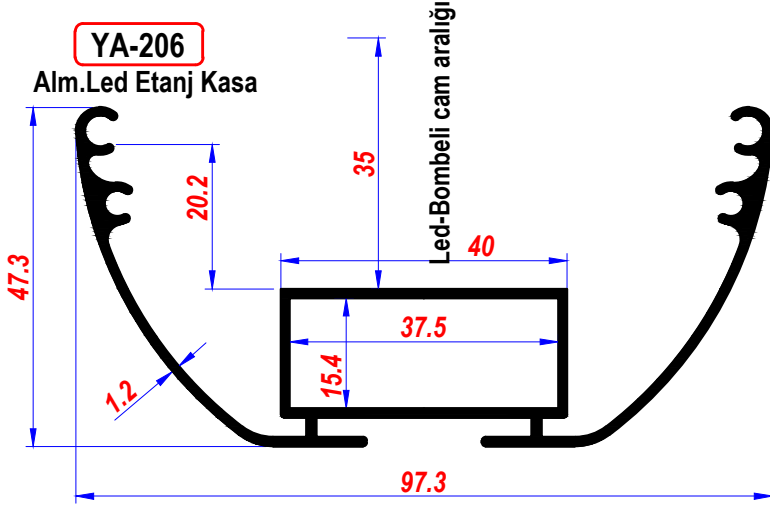

**YA-206 A**  
P.C. Difüzör  
Opal - Çizgisiz

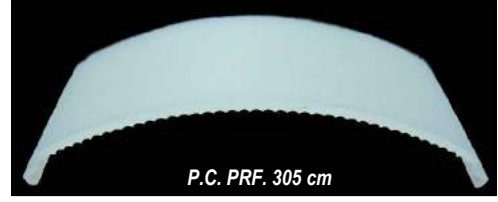

**YA-206 G**  
P.C. Difüzör  
Opal - Çizgisiz

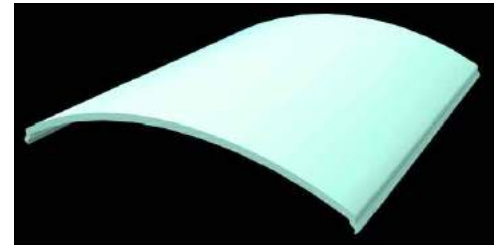

**YA-206 B**  
Zamak Enj. Tapa - Conta



**YA-206 C**  
Pls. Tapa + Conta -Siyah

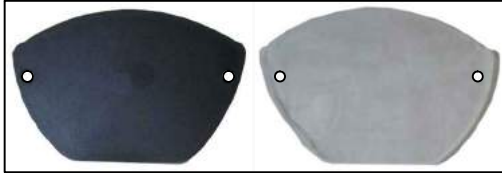

**YA-206 D**  
Alm. Lazer Tapa  
Bomb.cam için

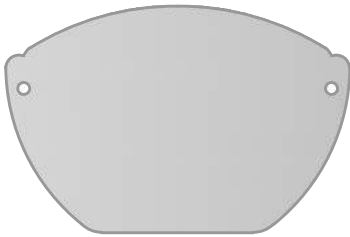

**YA-206 E**  
PMMA Akrilik Difüzör  
Opal - Şeffaf



**YA-206 D1**  
Alm. Lazer Tapa - Düz Camlar İçin

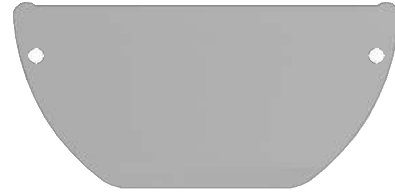

**UYGULAMA ŞEKLİ ; İÇ MEKAN SARKIT  
TAVAN - DUVAR MONTAJ**

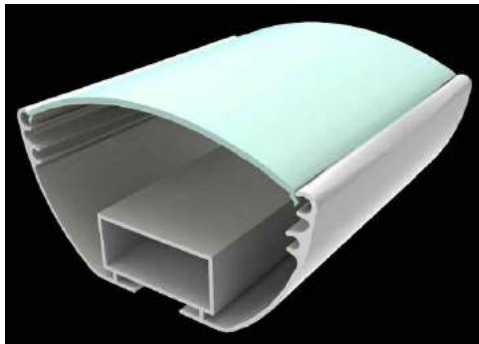

**YA-207 D**  
Tavan Askı Aparatı  
Tekli-Krom



**YA-207 D1**  
Tavan Askı Aparatı  
İkili-Krom



standart tel uzunluğu 1,5 mt  
özel tel ölçüsü sipariş edilebilir

**İSTENİLEN ÖLÇÜLERDE KESİM YAPILIR**  
All cutting dimensions can be done according to requirements



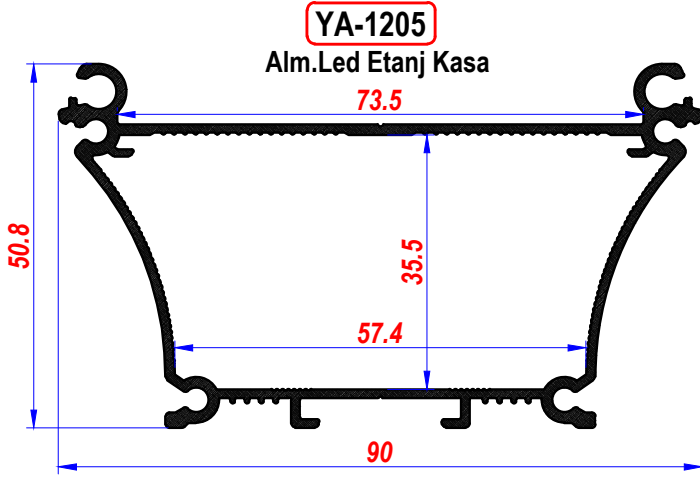

### OTOPARK UYGULAMASI



- \* IP 66 korumalı, fitilli etanj kasa
- \* Geniş driver alanı; 35,5 x 57,4 mm ( Acil aydınlatma kitine uygun )
- \* Paslanmaz klipsle, kolay tavan montajı
- \* PC.Dif. ile Alm. Prf. arasında, sızdırmaz fitili
- \* Sarkıt olarak kullanıma uygun aksesuarlar
- \* Alt tırnağına ayak seti (YA 253 serisi) montaj edilerek, açılı kullanabilme imkanı

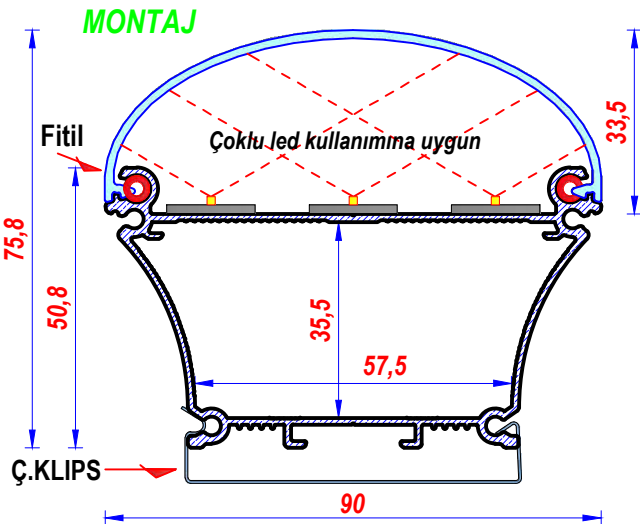
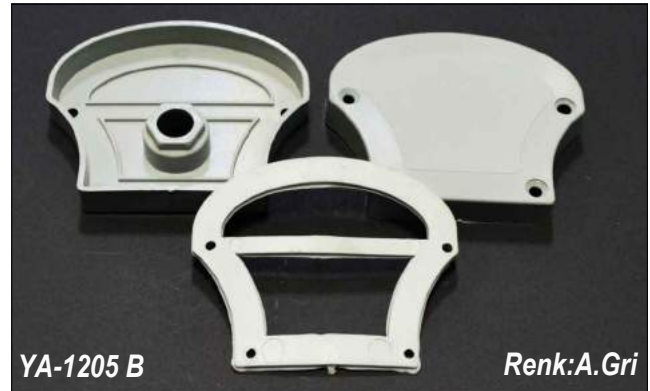
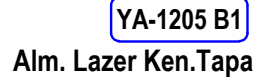
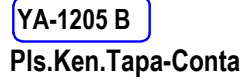
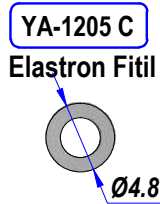
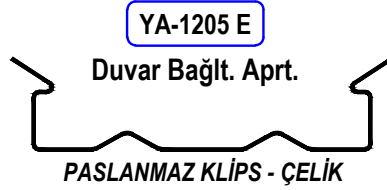
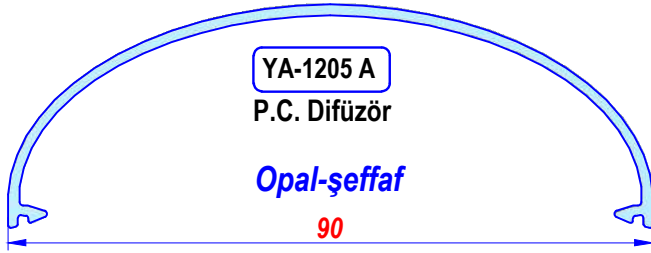

### YA-1205 ALM.PR.F. VE AKSESUARLARI



İSTENİLEN ÖLÇÜLERDE KESİM YAPILIR  
All cutting dimensions can be done according to requirements

**YA-208**  
Alu.Led  
Etange Case

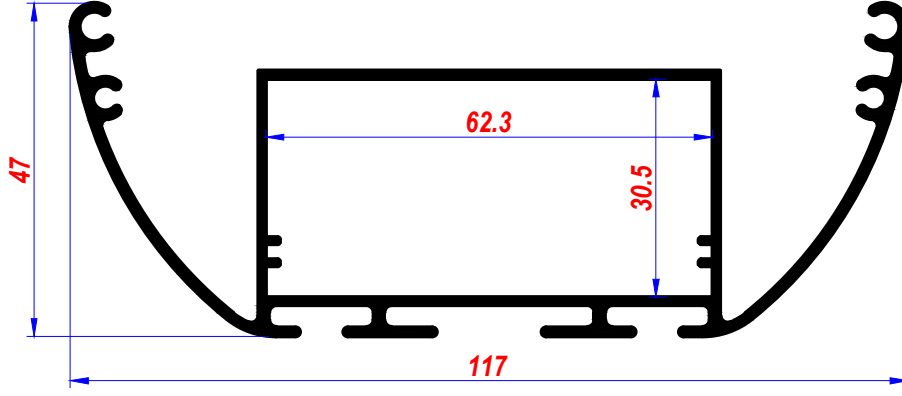

**YA-208 A**  
PC. Diffuser  
Opal - Transparent

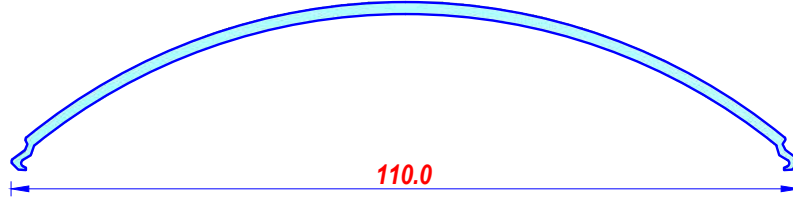

**YA-208 B**  
Plastic End Cap  
Black

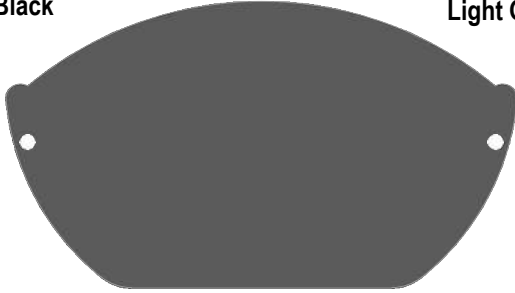

**YA-208 C**  
Alu. Laser End Cap  
Light Gray



**USAGE AREA; INDOOR / OUTDOOR AND AQUARIUM**

**YA-P01**  
Alu.Led Etange Case

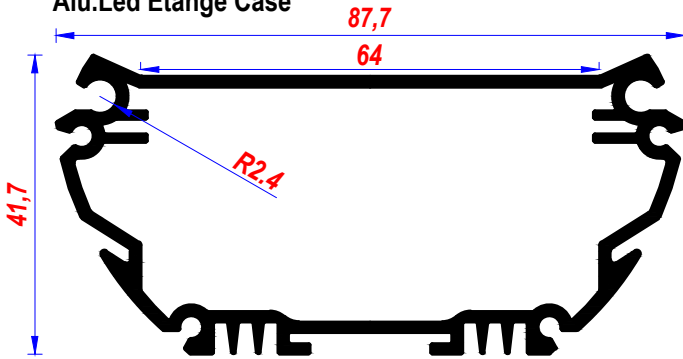

**YA-P01 A**  
PC. Diffuser  
Opal - Transparent

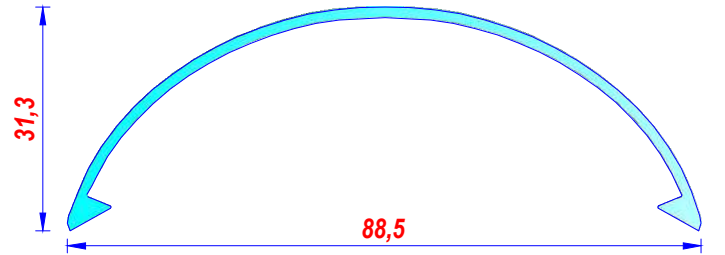

**YA-P01 B**  
Alu. Laser End Cap  
Light Gray

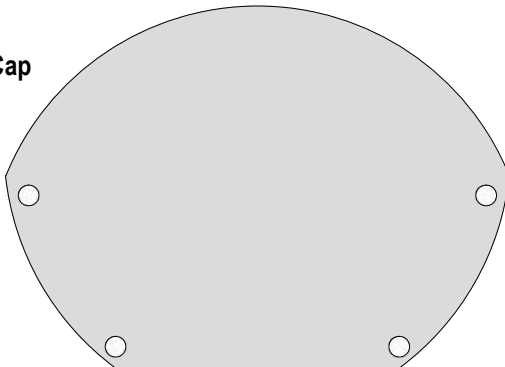

**YA-1205 C**  
Elastron Wick

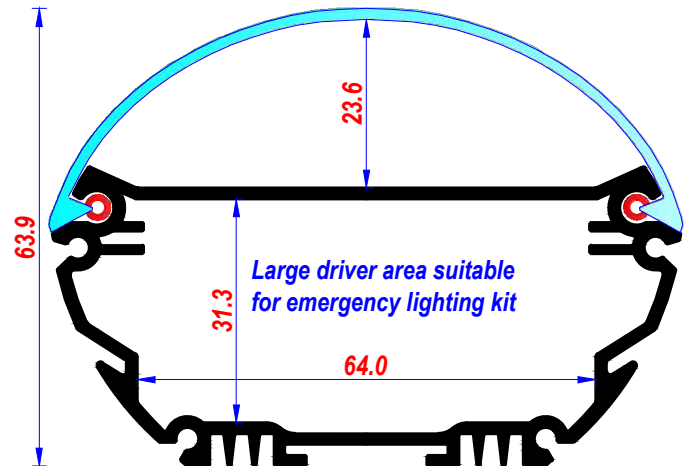

YÜKSEK TAVAN IP 66 PC - COEX ETANJ KASALAR

EP-100

Plastik Led Etanj Kasa

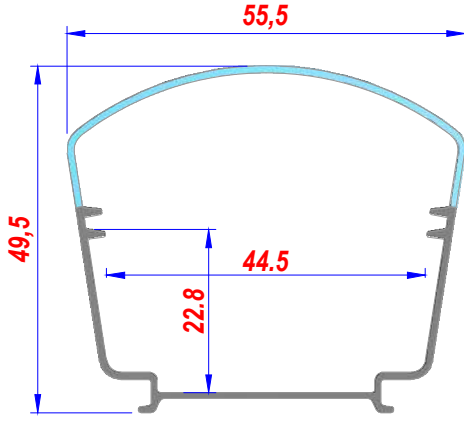

IP 66 KOEKS KÜÇÜK PC. KASA

Otopark vb-Yüksek tavan aydınlatma  
Paslanmaz klipsle, kolay tavan montajı  
İç ve Dış mekanlarda kullanıma uygun  
Benzerlerinden daha ekonomik ürün

P.C. ve ALM PRF. 305 cm



P.C. PRF.-ALM. SÜRGÜ PRF.

EP-100 T

Pls.Kenar Tapa



VİDASIZ SIKI GEÇME

EP-100 A

Alm.İç Sürgü Prf.



Alüminyum İç kızak-sürgü profili

EP-100 D

Duvar Bağlt. Aprt.



PASLANMAZ KLİPS - ÇELİK

EP-101

Plastik Led Etanj Kasa

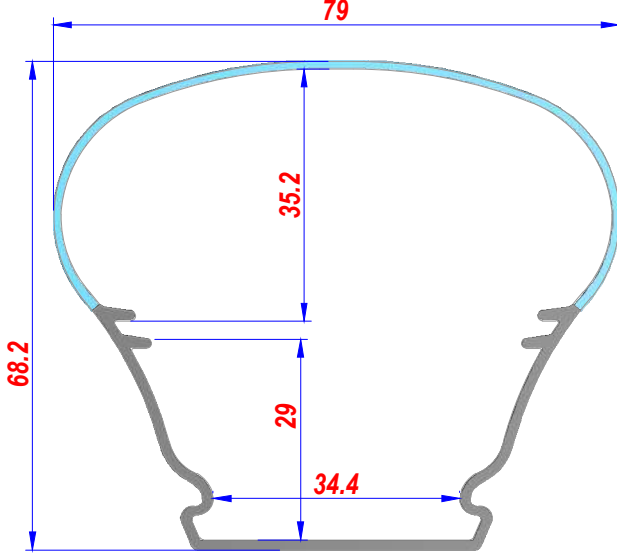

IP 66 KOEKS BÜYÜK PC. KASA

Otopark vb-Yüksek tavan aydınlatma  
Paslanmaz klipsle, kolay tavan montajı  
İç ve Dış mekanlarda kullanıma uygun  
Benzerlerinden daha ekonomik ürün

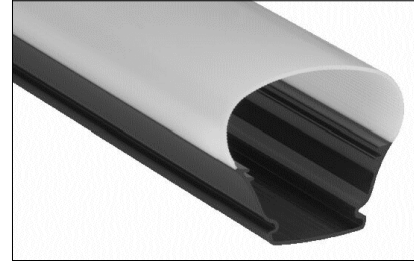

PLASTİK - P.C. IP 66, ETANJ KASA

EP-101 A

Alm.İç Sürgü Prf.

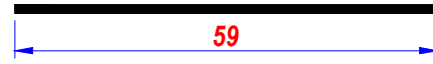

EP-101 D

Duvar Bağlt. Aprt.

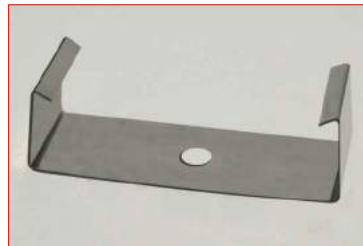

PASLANMAZ KLİPS - ÇELİK

EP-101 T

Pls.Kenar Tapa



VİDASIZ SIKI GEÇME

İSTENİLEN ÖLÇÜLERDE KESİM YAPILIR

All cutting dimensions can be done according to requirements

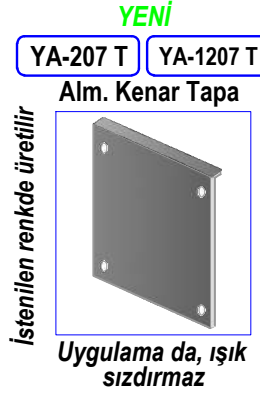
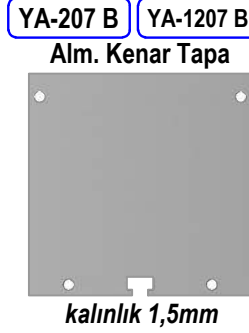
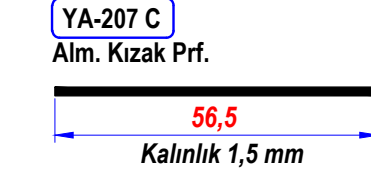
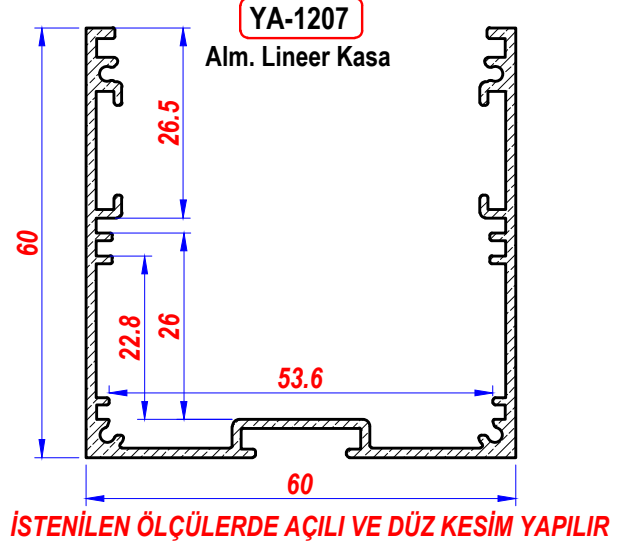
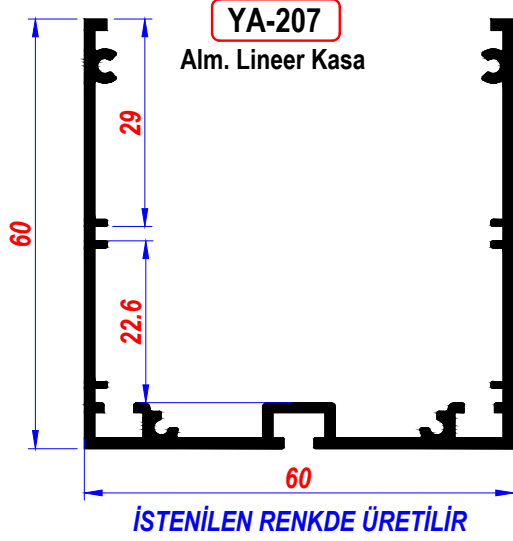

**UYGULAMA ŞEKLİ**  
ASKI APARATLARI İLE SARKIT,  
TAVAN-DUVARA VIDA İLE SABİTLEYEREK  
YA-1207 AÇILI KESİM YAPILARAK, FARKLI  
ŞEKİLLERDE ÇERÇEVE ÜRETİLEBİLİR  
METAL KÖŞELER, ALM. LİNEER PROFİLLERE  
UYGUN ÜRETİLMİŞTİR

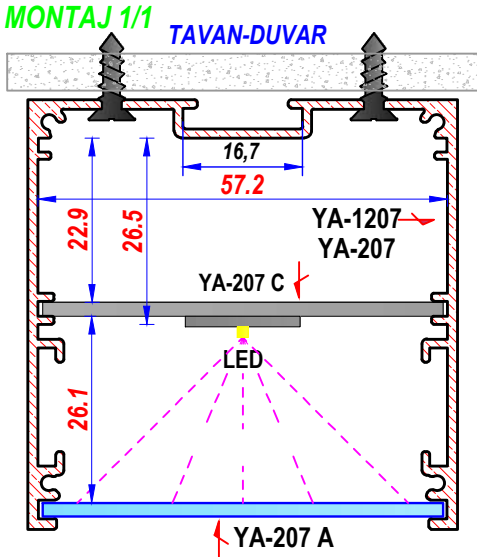

özel tel ölçüsü, sipariş edilebilir



All cutting dimensions can be done according to requirements



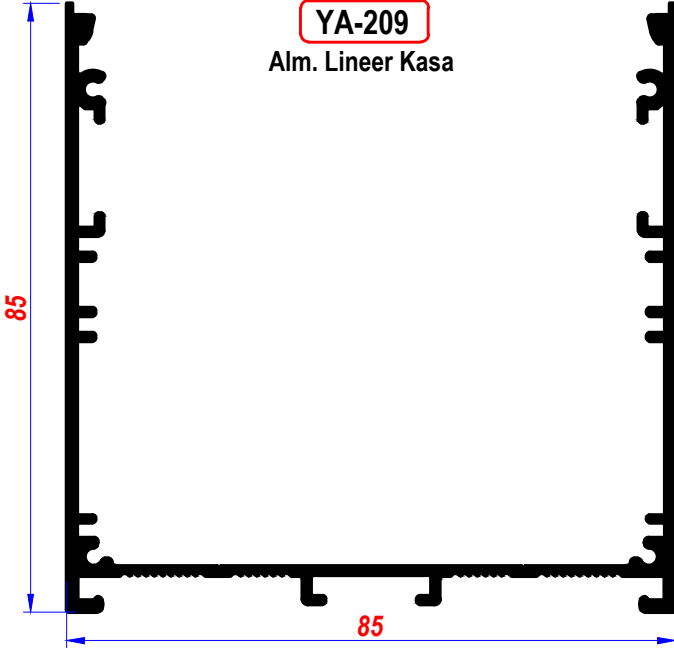

**YA-209**  
Alm. Lineer Kasa

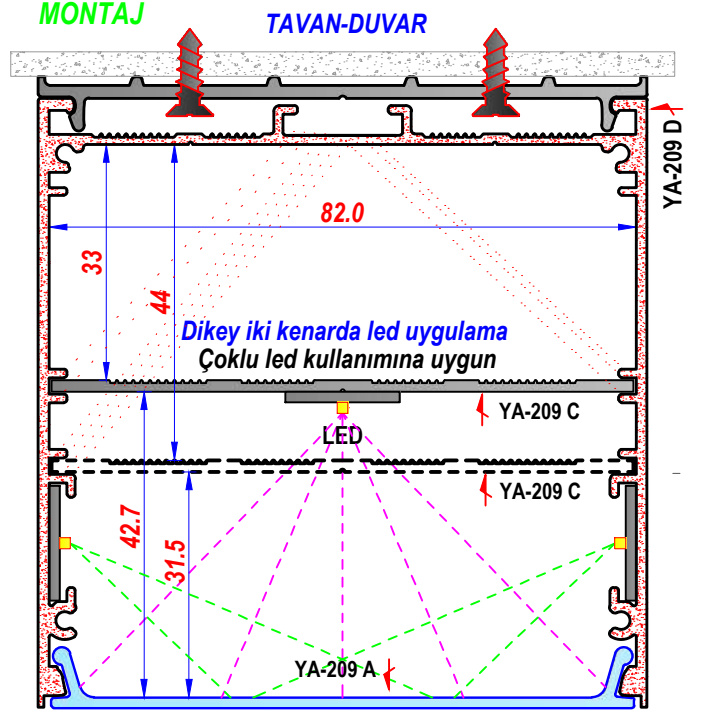

İsteğe göre tavan montaj profiliyle birlikte kullanılır

Kare-Dikdörtgen uygulamasına uygun ürün

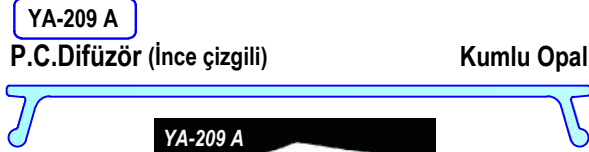

**YA-209 A**

P.C. Difüzör (İnce çizgili)

Kumlu Opal

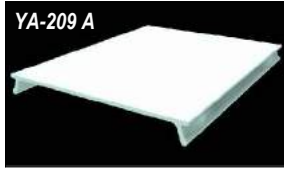

**PC.DİFÜZÖR-ALM.PRF. 610 cm**

**YA-209 C**

Alm. İç Kızak Prf.

ALM.PRF.610 cm

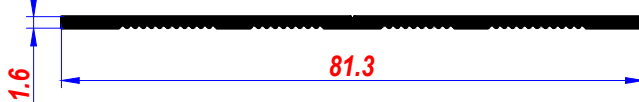

**YA-209 D**

Alm. Prf. (Duvar Montaj)

ALM.PRF.610 cm

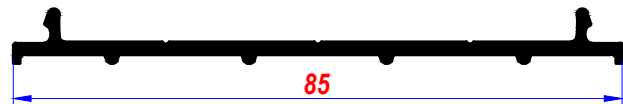

Tavan-Duvar Montaj Prf.

**KARE UYGULAMASI**

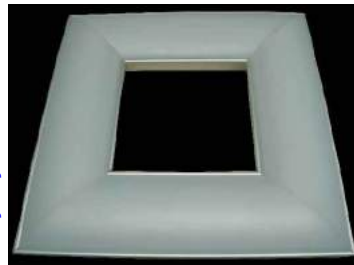

İSTENİLEN ÖLÇÜLERDE ÇERÇEVE YAPILIR

<b>YA-207 D</b>	Tekli
Tavan Askı Aparatı	
<b>YA-207 D1</b>	İkili
Tavan Askı Aparatı	
<b>YA-207 E</b>	
Dikey 90° Metal Köşe	
<b>YA-207 E1</b>	
Yatay 90° Köşe-Metal	
<b>YA-207 E 2</b>	
Metal askı teli tutucu	

**YA-209 B**  
Alm.Ken.Tp.

Kalınlık 1,5 mm

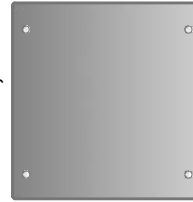

İstenilen renkte üretilir

**YA-209 T** **YENİ**  
Alm.L Ken.Tp.

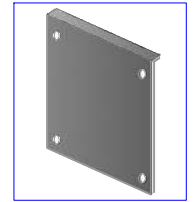

Uygulama da, ışık sızdırmaz

İÇ MEKAN, ASKI APARATLARI İLE SARKIT,  
YA-209 D kullanılmadan, Tavan veya duvara,  
vidayla sabitlenerek kullanılabilir

MONTAJ



YA-209  
YA-209 A  
YA-209 C  
YA-209 D

İsteğe göre; YA-209 D, Tavan veya duvara vidayla sabitlenir, daha sonra ana kasa, sıkı geçme takılır



İSTENİLEN ÖLÇÜLERDE KESİM YAPILIR

All cutting dimensions can be done according to requirements

TÜRKİYE DE BU GENİŞLİKTE LİNEER KASA, İLK ve TEK

YA-216

Alm. Lineer Kasa

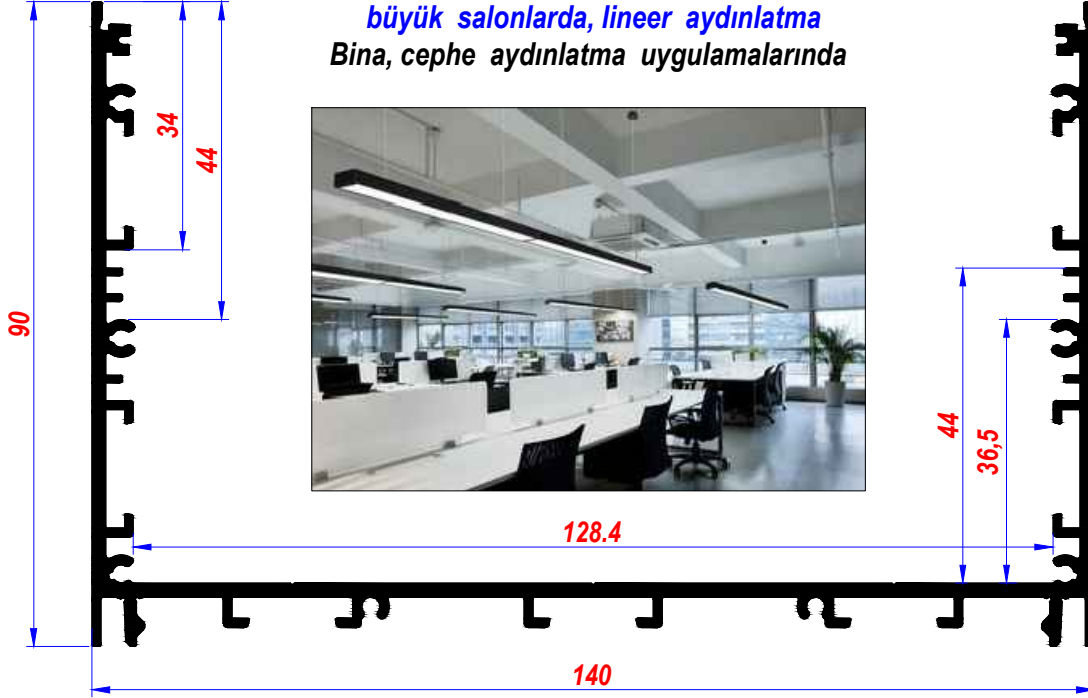

Eğlence, Lobi, showroom gibi yüksek tavanlı büyük salonlarda, lineer aydınlatma Bina, cephe aydınlatma uygulamalarında

PC.DİFÜZÖR-ALM.PRF. 610 cm

YA-216 A

Alm. Prf.

Tavan montaj-İç Kızak Prf.

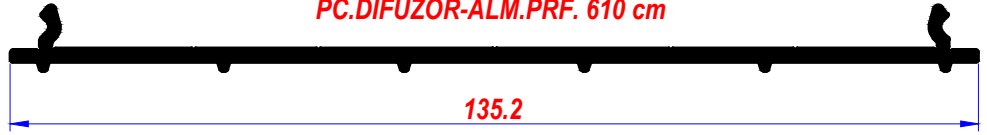

Yüksek tavanlı mekanlarda, tavan montaj profili İç kızak profili olarak da kullanılabilir

YA-216 B

P.C.Difüzör

OPAL

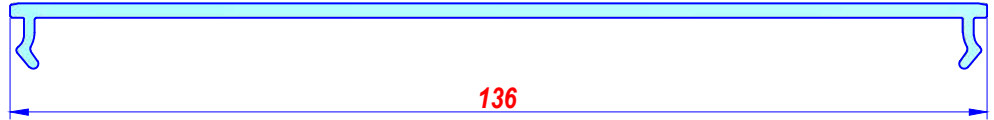

Havaalanı - Stadyum - Tünel - Metro İstasyonu gibi büyük tesislerde, acil aydınlatma ve yönlendirme amaçlı kullanımlara uygun ürün

YA-216 C

Alm.Kenar Tapa

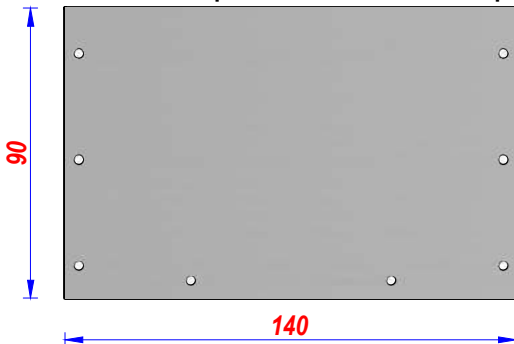

YENİ

YA-216 L

Alm. L Ken. Tp.

askı aparatları ile, sarkıt olarak da kullanılabilir

TAVAN-DUVAR

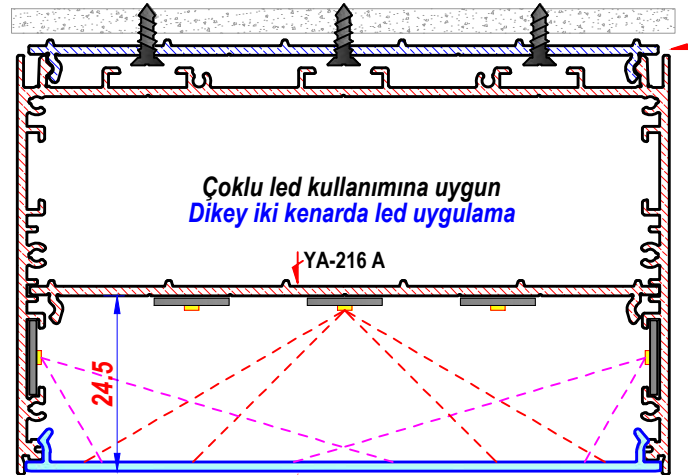

YA-216 A (Tavan Montaj Prf.)

MONTAJ

İSTENİLEN ÖLÇÜLERDE KESİM YAPILIR

All cutting dimensions can be done according to requirements

YENİ

YA-210

Alm. Led Kasa (Orta)  
SIVA ALTI

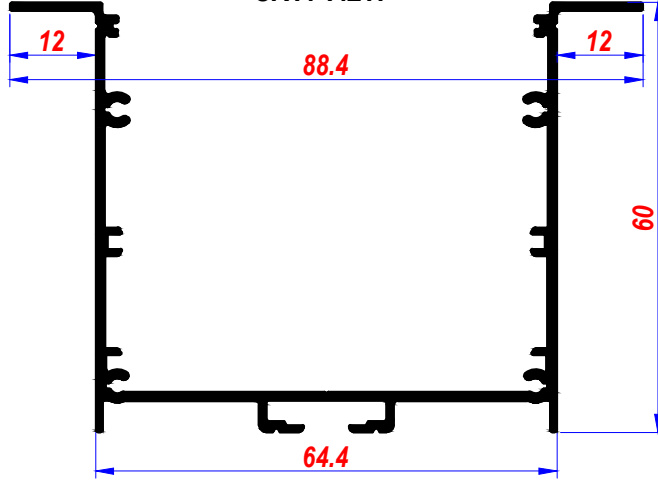

ALÇI TAVAN ve DUVARA GÖMME OLARAK  
KESİNTİSİZ UYGULANABİLEN  
DEKORATİF YENİ ÜRÜN

YA-1210 A

P.C. Difüzör



PC.DİFÜZÖR-ALM.PRF. 610 cm

YA-1210 C

Alm. İç Kızak Prf.

Kalınlık 1,5 mm



Kolay montaj, alçıpanı parçalamadan  
çıkartabilmeye uygun, 2 farklı sistem  
Tek kişi ile montaj kolaylığı

YA-210 A

Alçıpan Montaj Aparatı-Metal

1,5 mm Galvaniz

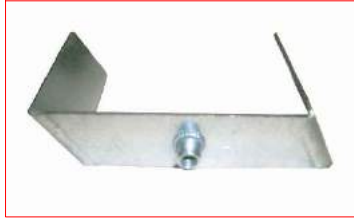

YA-G 50 C

Alçıpan İkili montaj yayı

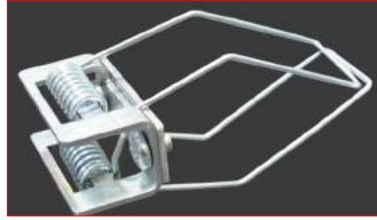

YA-210 B

Alm.Kenar Tapa



İki farklı montaj şekli olan, ( Aşağıdaki uygulama 1-2 gibi )  
Alçıpan - duvar ve ahşaba, ankastre olarak uygulanır

UYGULAMA 1

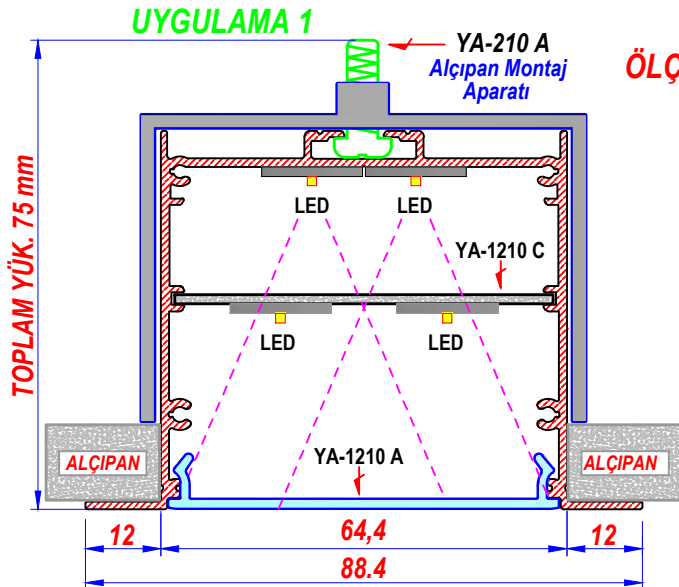

ÖLÇEKSİZ

YA-G 50 C  
Alçıpan İkili  
Montaj Yayı

UYGULAMA 2

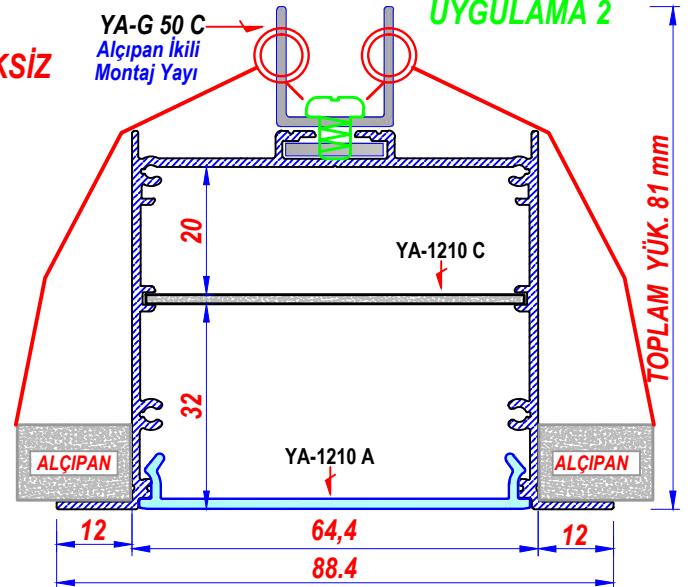

İSTENİLEN ÖLÇÜLERDE KESİM YAPILIR  
All cutting dimensions can be done according to requirements

YA-211

Alm. Led Kasa (Büyük)  
SIVA ALTI

109

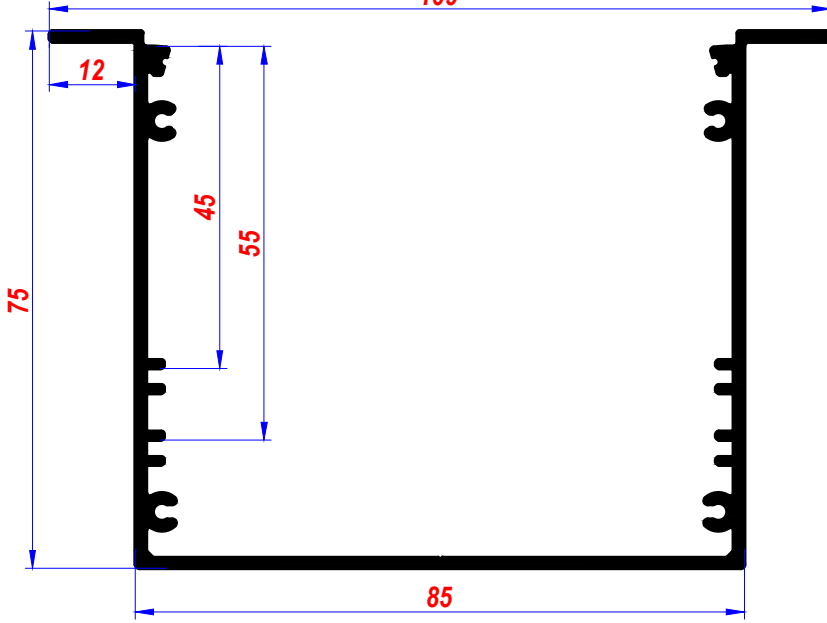

YA-211 A

Alçıpan Montaj Aparatı-Metal



1,5 mm Galvaniz

YA-211 B

Alm.Kenar Tapa



### MONTAJ



YA-209 A

P.C.Difüzör (İnce çizgili)

Kumlu Opal



YA-209 C

Alm. İç Kızak Prf.

ALM.PRF.610 cm



### MONTAJ

Tek - Çift sıra led  
Kullanımına uygun

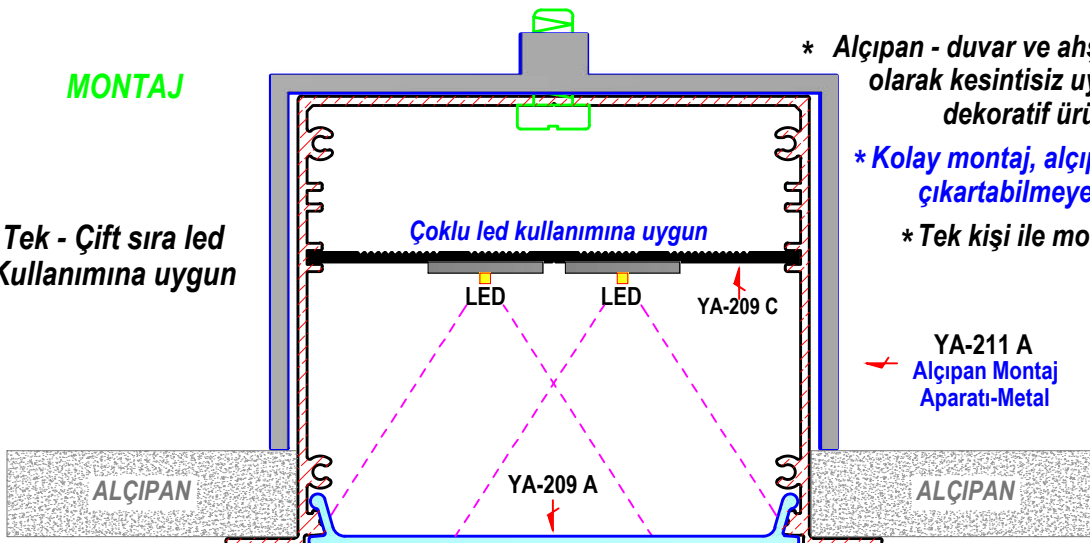

\* Alçıpan - duvar ve ahşaba, ankastre olarak kesintisiz uygulanabilen dekoratif ürün

\* Kolay montaj, alçıpanı parçalamadan çıkartabilmeye uygun sistem

\* Tek kişi ile montaj kolaylığı

YA-211 A  
Alçıpan Montaj  
Aparatı-Metal

İSTENİLEN ÖLÇÜLERDE KESİM YAPILIR

All cutting dimensions can be done according to requirements

YENİ

YA-212

Alm. Led Kasa (Küçük)  
SIVA ALTI

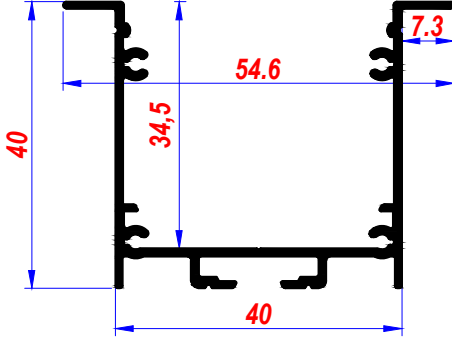

ALÇI TAVAN ve DUVARA GÖMME OLARAK  
KESİNTİSİZ UYGULANABİLEN  
DEKORATİF YENİ ÜRÜN

YA-1209 A

P.C. Difüzör

Opal-Şeffaf



P.C. DİFÜZÖR 610 cm

YA-213 U

P.C. U Difüzör

Opal

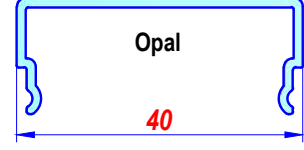

YA 213 U PC CAM

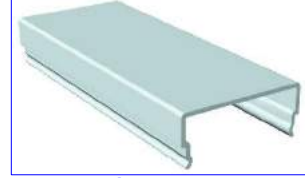

P.C. DİFÜZÖR 610 cm

YA-1209 C

Alm. Kızak Prf.



36.5

YA-210 B

Alm. Kenar Tapa



YA-210 A

Alçıpan Montaj Aparatı-Metal

1,5 mm Galvaniz



YA-G 50 C

Alçıpan İkilili montaj yayı

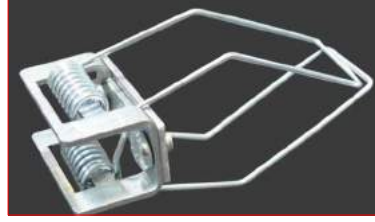

İki farklı montaj şekli olan, ( Aşağıdaki uygulama 1-2 gibi )  
Alçıpan - duvar ve ahşaba, ankastre olarak uygulanır  
Kolay montaj, alçıpanı parçalamadan  
çıkartabilmeye uygun, 2 farklı sistem  
Tek kişi ile montaj kolaylığı



UYGULAMA 1 MONTAJ

UYGULAMA 1

ÖLÇEK 1/1

UYGULAMA 2

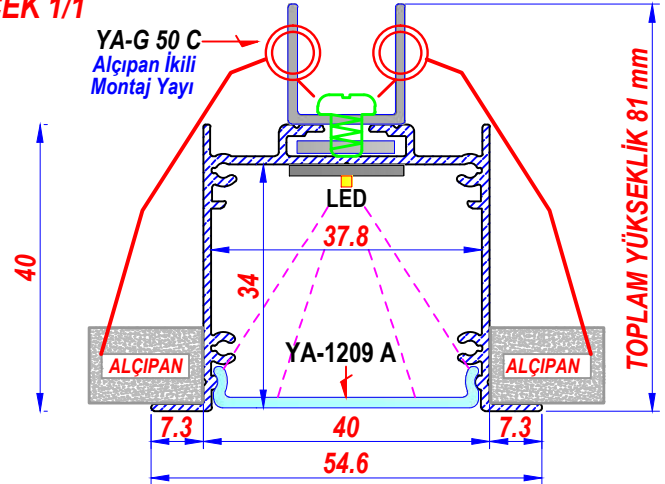
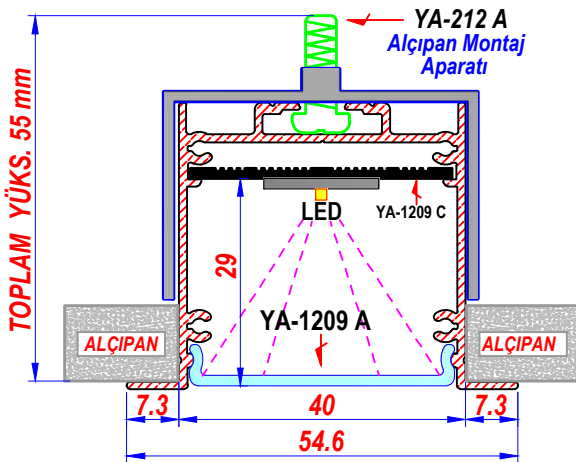

İSTENİLEN ÖLÇÜLERDE KESİM YAPILIR

All cutting dimensions can be done according to requirements

YENİ, SIVA ALTI - ANKASTRE KASA

YENİ

YA-AG 35

Alm.Siva Altı Led Kasa

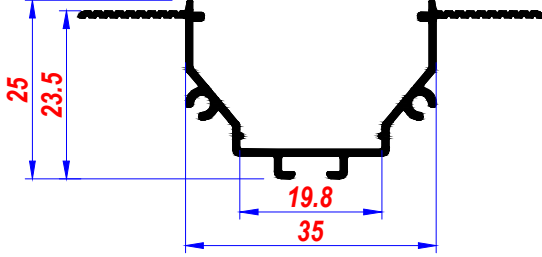

Alçıpan için özel üretilmiştir

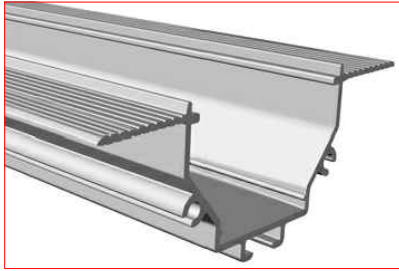

ALM.- PRF. 610 cm

YA-G 35 C

PC.Cam-Difüzör

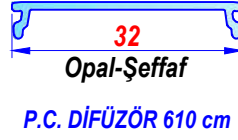

YA-AG 35 T

Alm. Ken.Tapa



Kalınlık 1 mm

YA-G 35 Y

Tekli Montaj Yayı



Tek vidalı

YA-AG 35

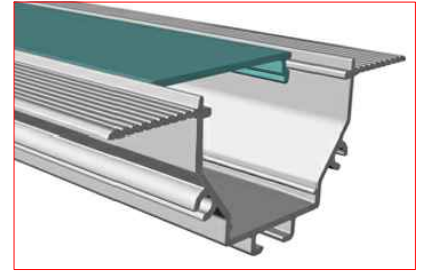

ALM.-PC.PRF. 610 cm

Alçıpana, kesintisiz monte edilerek uygulanabilen, dekoratif siva altı Ankastr yeni küçük ürün

UYGULAMA 1

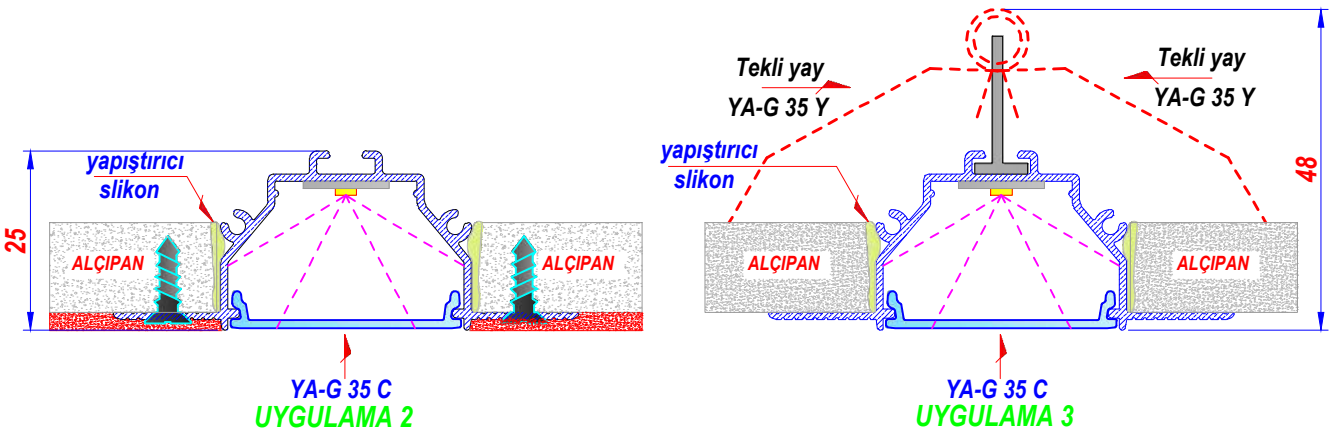
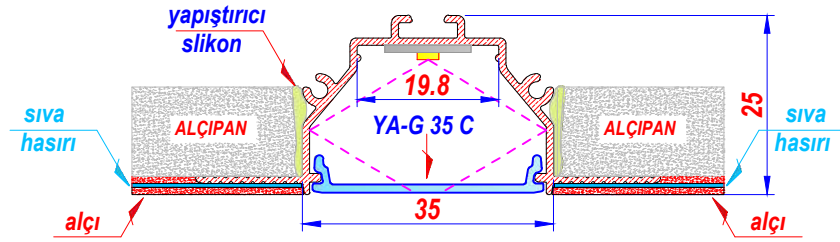

YA-G 35 C  
UYGULAMA 2

YA-G 35 C  
UYGULAMA 3

İSTENİLEN ÖLÇÜLERDE KESİM YAPILIR  
All cutting dimensions can be done according to requirements

**YA-G 35**

Alm.Sıva Altı Led Kasa

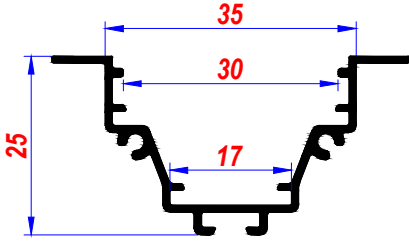

YA-G 35

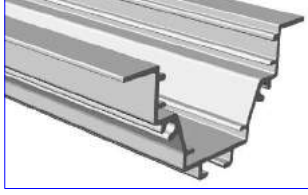

ALM.-PC.PRF. 610 cm

**YA-G 35 C**

PC.Cam-Difüzör

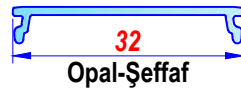

**MONTAJ**

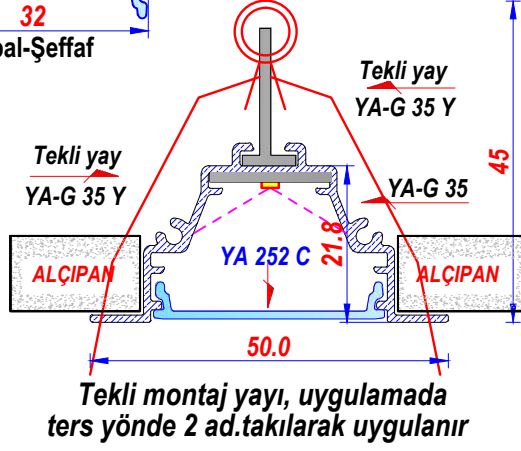

Tekli montaj yayı, uygulamada ters yönde 2 ad.takılarak uygulanır

**YA-G 35 T**

Alm. L Ken.Tapa

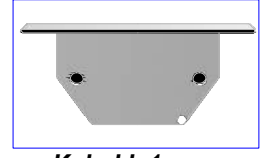

Kalınlık 1 mm

**YAKINDA**

**YA-G 35 Y**

Tekli Montaj Yayı



Tek vidalı

**TEKLİ YAY**

**YA-G 50 Y**

Alm.Sıva Altı Led Kasa

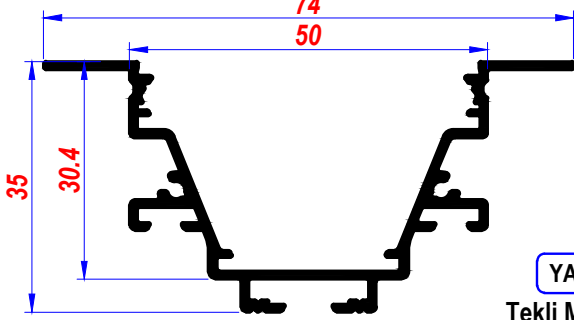

**YA-G 50 A**

PC.Cam-Difüzör

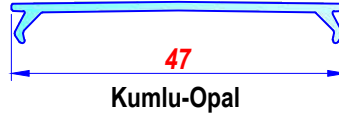

**YA-G 50 T**

Alm. L Ken.Tapa

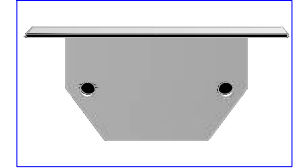

Kalınlık 1 mm

**YA-G 35 Y**

Tekli Montaj Yayı



Tek vidalı

**YA-G 50 C**

Alçıpan İkilili montaj yayı



U genişlik 20 mm

**YA-G 50 D**

U Montaj Aparatı-Metal



YA G 50 D aparat ile de, alçıpana montaj yapılabilir

YENİ NESİL GÖMME ÜRÜNLERDE

Üç farklı montaj şekli olan, yeni nesil Ekonomik ve dekoratif ürün

**UYGULAMA 2**

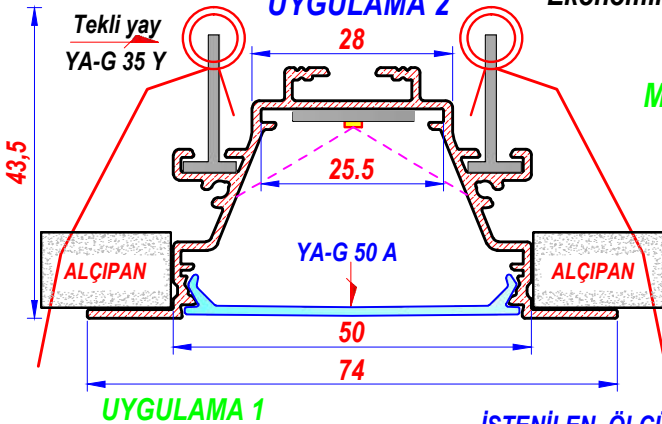

**UYGULAMA 1**

**UYGULAMA 1**

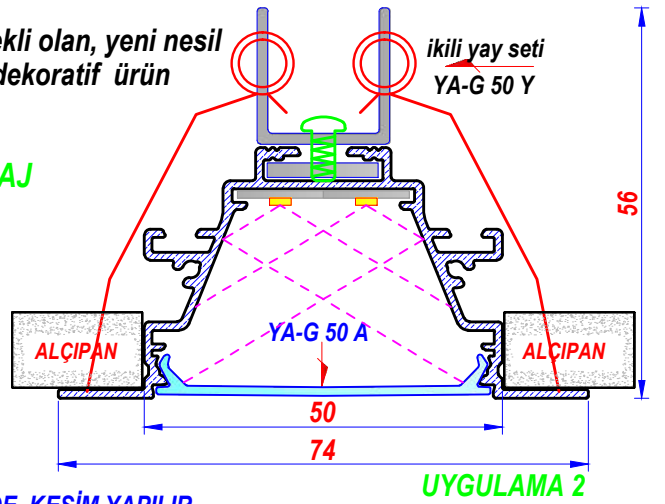

**UYGULAMA 2**

İSTENİLEN ÖLÇÜLERDE KESİM YAPILIR

All cutting dimensions can be done according to requirements

YA-G 60

Alm.Siva Altı Led Kasa

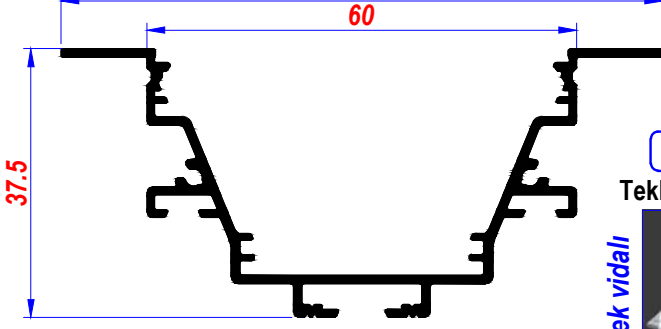

YA-220 C

PC.Cam-Difüzör



Opal-Şeffaf

YA-G 60 T

Alm. L Ken.Tapa

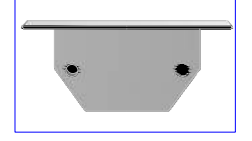

YA-G 35 Y

Tekli Montaj Yayı

Tek vidalı



YENİ YA-G 50 C

Alçıpan İkili montaj yayı



YA-G 60 D

U Montaj Aparatı-Metal



Üç farklı montaj şekli olan, yeni nesil ekonomik ankastre ürün.  
YA G 60 D aparat ile de, alçıpana montaj yapılabilir

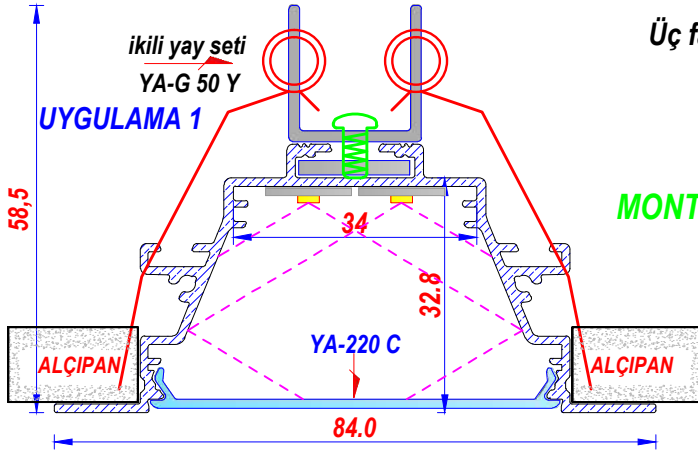

MONTAJ

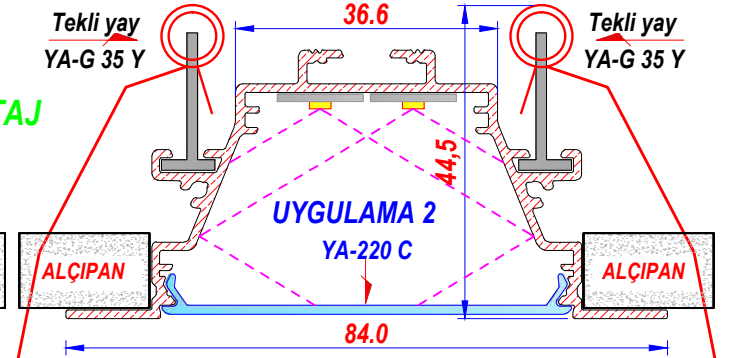

803 g YA-G 75

Alm.Siva Altı Led Kasa

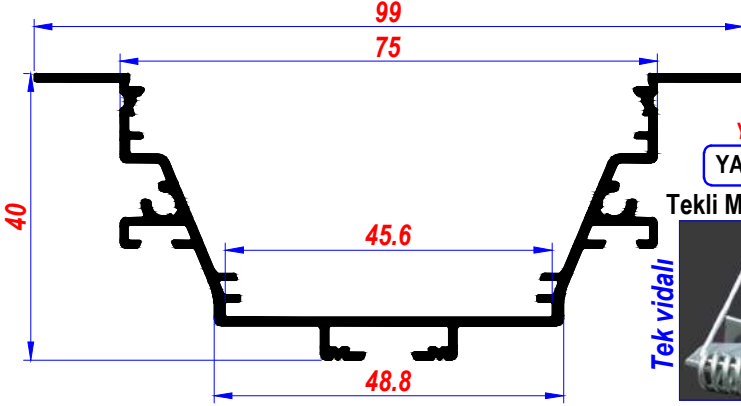

YA-222 C

PC.Cam-Difüzör

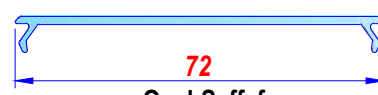

Opal-Şeffaf

YA-G 75 T

Alm. L Ken.Tapa

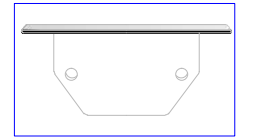

YENİ YA-G 35 Y

Tekli Montaj Yayı

Tek vidalı



YENİ YA-G 50 C

Alçıpan İkili montaj yayı

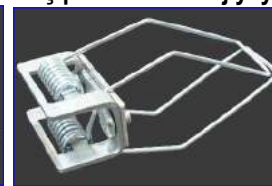

YA-G 75 D

U Montaj Aparatı-Metal



Üç farklı montaj şekli olan, yeni nesil ekonomik ankastre ürün  
YA G 75 D Aparat ile de, alçıpana montaj yapılabilir

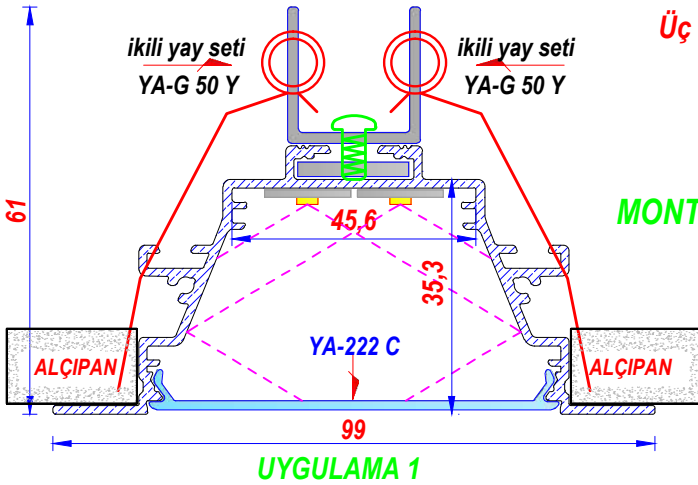

MONTAJ

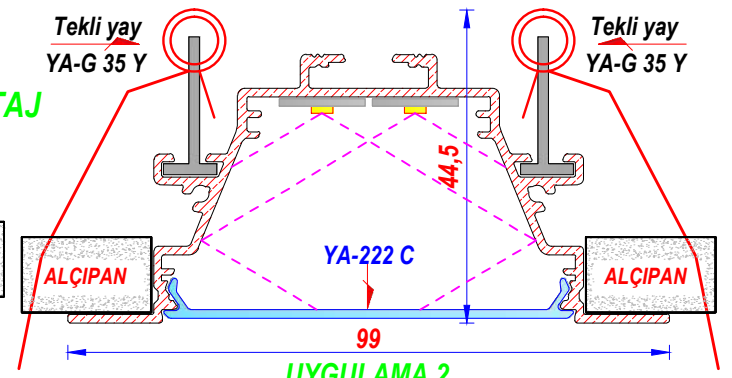

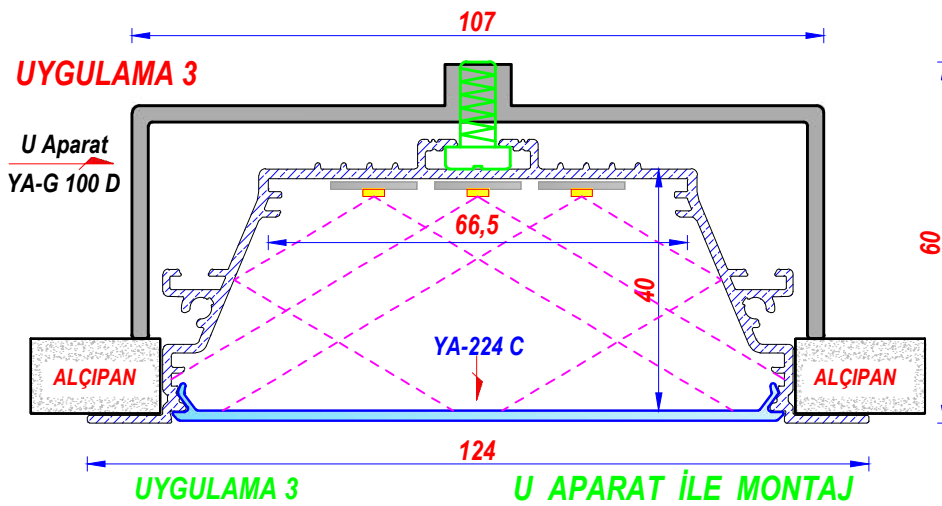
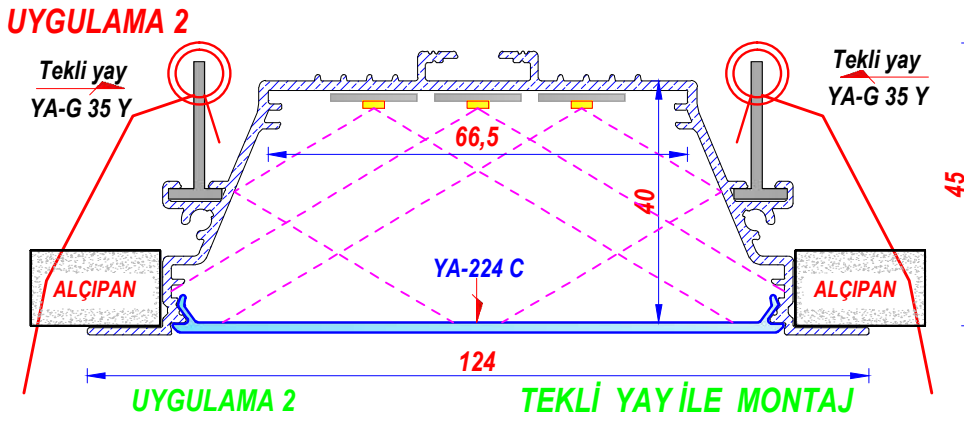
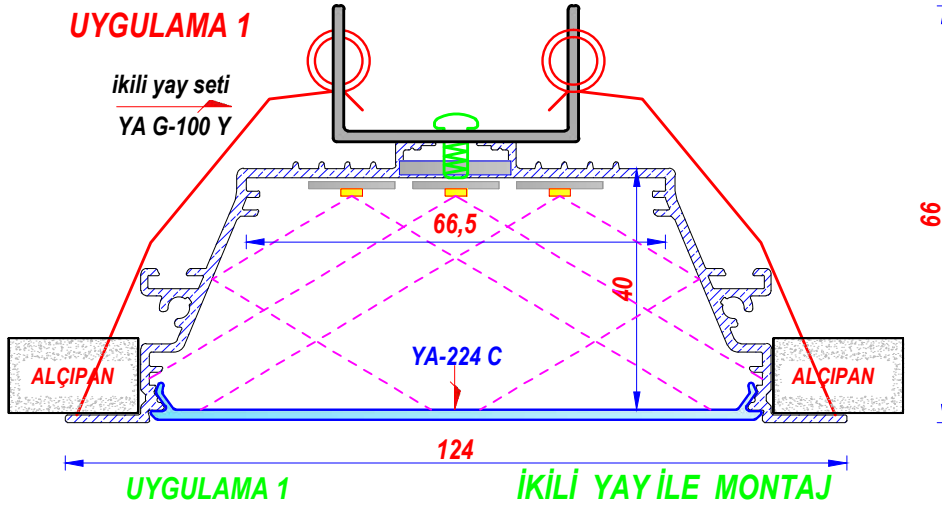
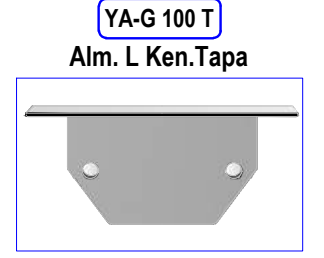
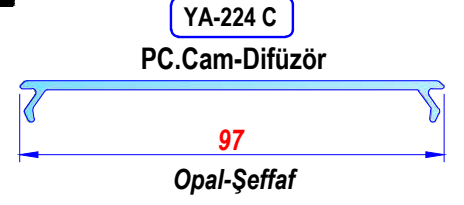
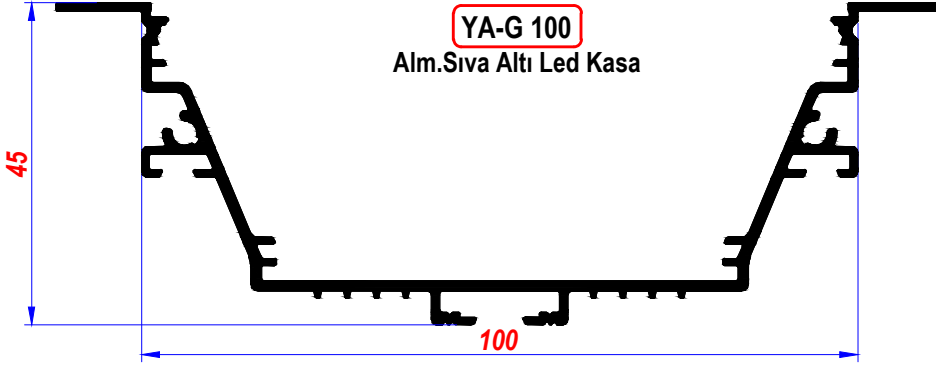

YA-218

Alm. Lineer Kasa

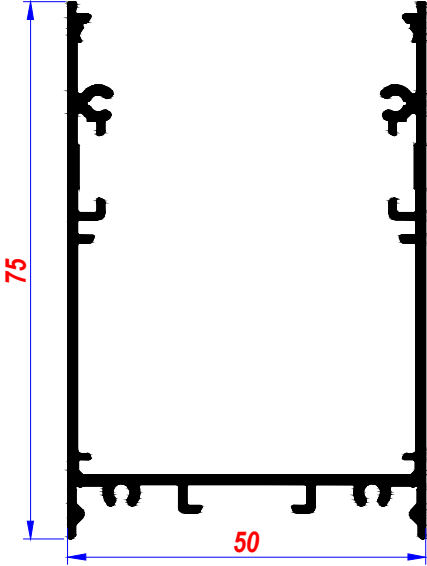

**İSTENİLEN RENKDE ÜRETİLİR**

Kare, Dikdörtgen, Altıgen gibi, çerçeve üretimine uygun ürün

YA-218 TAKIM, MONTAJ

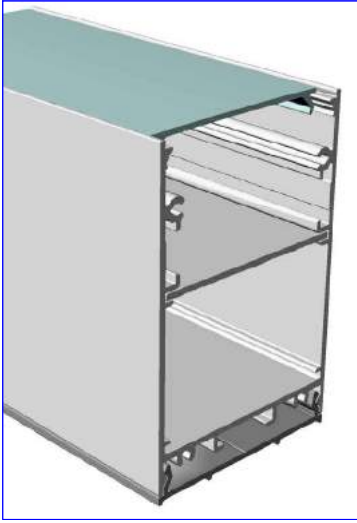

ALM.-PC.PRF. 610 cm

YA-G 50 A

PC.Cam-Difüzör

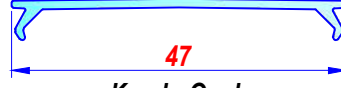

Kumlu-Opal

PC.Cam-Difüzör, üstten tatlı sıkı, takılıp çıkartılabilir

YA-218 T Alm.L Kenar tapa yeni üründür. DİFÜZÖR ile tapa arasında, ışık sızdırmaz. Düz tapaya göre, daha dekoratiftir. İstenilen renge boyanabilir

YA-218 B

Alm. Kızak Prf.



Kalınlık 1,5 mm

YA-205 D

Alm. Prf. (Duvar Montaj)

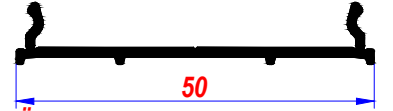

Ürün, 5 cm kısa parçalar halinde bağlantı klipsi gibi de kullanılır

YA-218 T

Alm. L Ken.Tapa

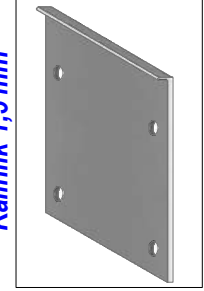

İstenilen renkte üretilir Kalınlık 1,5 mm

Difüzör ile tapa arasında, ışık sızdırmaz.

Lineer ürünlerde, Yeni L TAPA

YA-207 D

Tavan Askı Aparatı



standart tel 1,5 mt

Tekli Krom

YA-207 D1

Tavan Askı Aparatı



özel tel ölçüsü sipariş edilebilir

İKİLİ-KROM

YA-207 E2

Askı Teli Tutucu



Kalınlık 2,5 mm

YA-207 E3

Metal Düz Gönye



Uz.110 mm Kalınlık 2,5 mm

YA-207 E

Dikey 90° Metal Köşe



Kalınlık 2,5 mm

YA-207 E1

Yatay 90° Metal Köşe



Kalınlık 2,5 mm

YA-207 E4

Metal Gönye



Kalınlık 2,5 mm

YA-207 E5

Yatay 120° Metal Köşe



Kalınlık 2,5 mm

YA-207 E6

Yatay 135° Metal Köşe



Kalınlık 2,5 mm

YA-207 E7

Yatay 150° Metal Köşe



Kalınlık 2,5 mm

**UYGULAMA ŞEKLİ ;**

**İÇ MEKAN, ASKI APARATLARI İLE SARKIT, TAVAN-DUVARA VİDA İLE SABİTLEYEREK**

YA-218 D Kullanılmadan, tavan veya duvara, direkt YA-218 i vidalayarak, uygulanır. isteğe göre, YA-218 D Tavana vidayla sabitlenir, daha sonra ana kasaya, sıkı geçme takılır.

**Z UYGULAMASI**

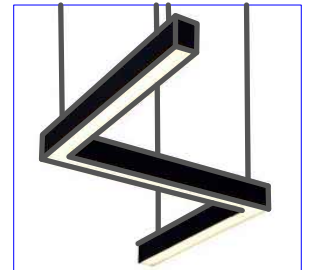

**İSTENİLEN ÖLÇÜLERDE KESİM YAPILIR**

All cutting dimensions can be done according to requirements

YA-220

Alm. Linear Kasa

İKİ YÖNLÜ LED AYDINLATMA

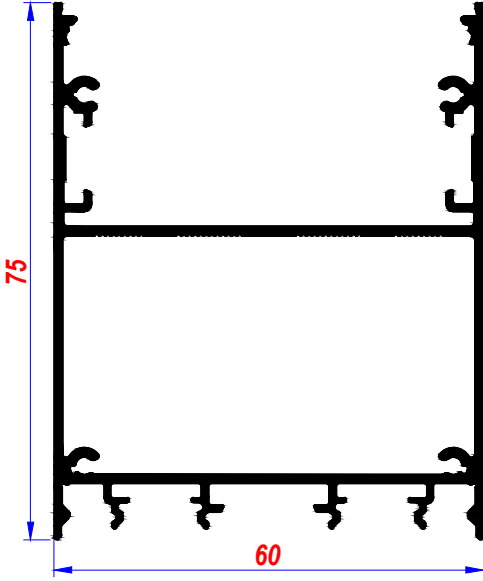

İSTENİLEN RENKDE ÜRETİLİR  
Kare, Dikdörtgen, Altıgen gibi, çerçeve  
üretimine uygun ürün  
YA-220 TAKIM, MONTAJ

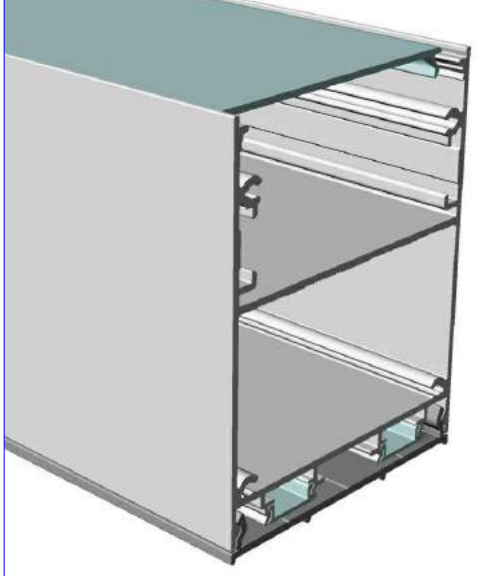

ALM.-PC.PRF. 610 cm SABİT KIZAKLI

KARE UYGULAMASI



Ürünlerle ilgili, köşe birleştirme aparatları mevcuttur

All cutting dimensions can be done according to requirements

YA-220 C

PC.Cam-Difüzör

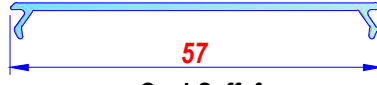

Opal-Şeffaf

PC.Cam-Difüzör, üstten tatlı sıkı,  
takılıp çıkartılabilir

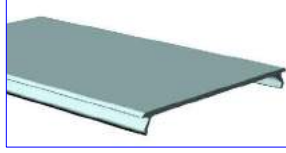

PC.PRF. 610 cm

Sarkıt uygulamalarda, aşağı ve  
yukarı aydınlatma imkanı sunar  
DİFÜZÖR ile tapa arasında, ışık sızdırmaz.  
Düz tapaya göre, daha dekoratiftir.  
İstenilen renge boyanabilir

YA-220 D

Alm. Prf. (Duvar Montaj)



ALM. PRF. 610 cm

YA-220 T

Alm. L Ken.Tapa

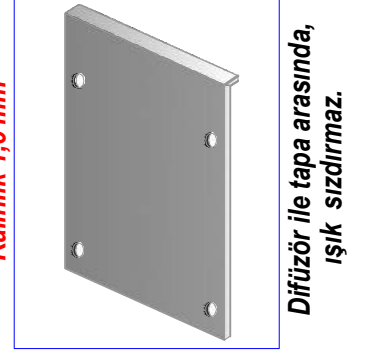

İstenilen renkte üretilir  
Kalınlık 1,5 mm

Difüzör ile tapa arasında,  
ışık sızdırmaz.

Lineer ürünlerde, Yeni L TAPA

YAKINDA

YA-019 C

PC.Cam-Difüzör

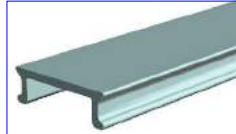

Sarkıt üründe Kullanılır

YA-207 D

Tavan Askı Aparatı



Standart tel 1,5 mt

YA-207 D1

Tavan Askı Aparatı



özel tel ölçüsü sipariş edilebilir

Tekli Krom

İkili-Krom

MONTAJ

TAVAN-DUVAR

YA-220 D

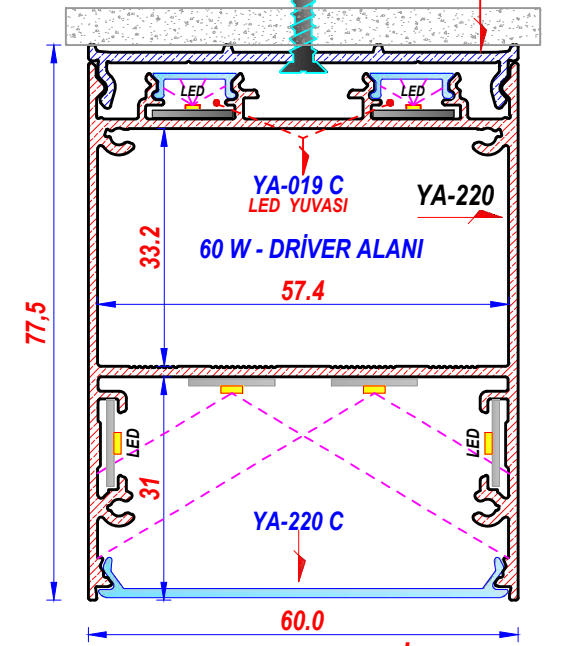

UYGULAMA ŞEKLİ

İç mekan, askı aparatları ile sarkıt,  
Tavan ve duvara sabitleyerek uygulanır

ALTIGEN UYGULAMASI



İSTENİLEN ÖLÇÜLERDE  
AÇILI KESİM YAPILIR

SIVA ÜSTÜ-SARKIT, İKİ YÖNLÜ LİNEER AYDINLATMA

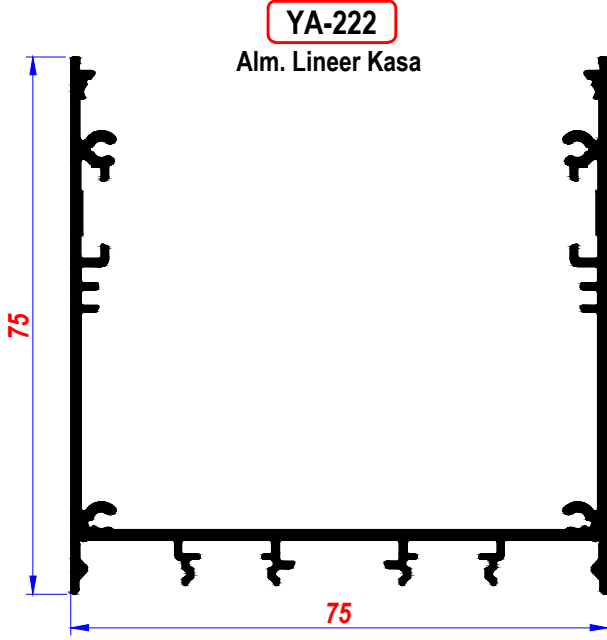

İSTENİLEN RENKDE ÜRETİLİR  
Kare, Dikdörtgen, Altıgen gibi, çerçeve  
üretimine uygun ürün

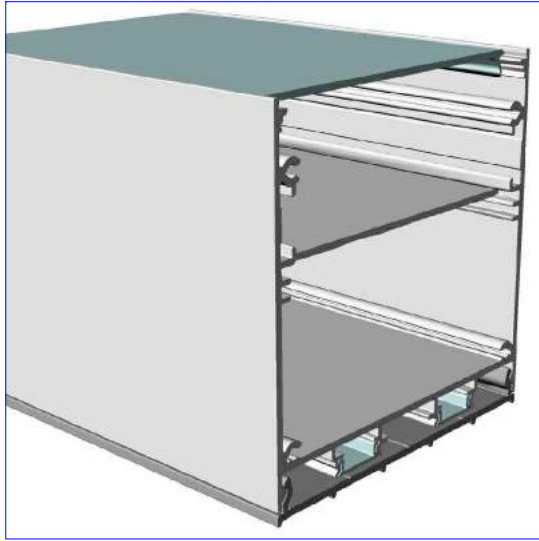

YA-222 TAKIM, MONTAJ

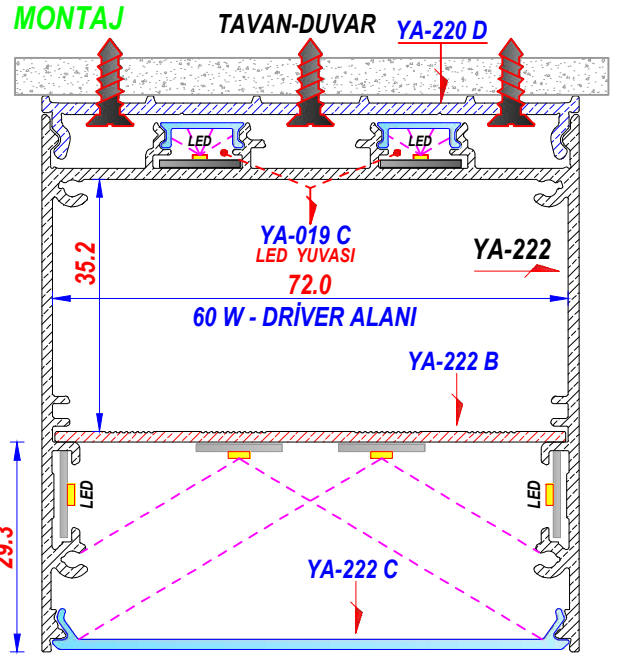
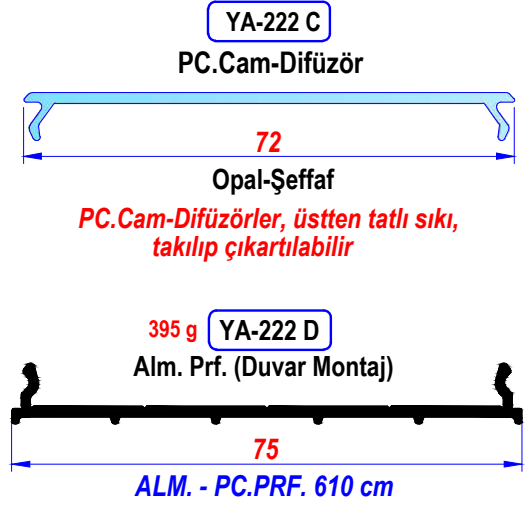

UYGULAMA ŞEKLİ

İç mekan, askı aparatları ile sarkıt,  
Tavan ve duvara direkt vida ile sabitleyerek.  
isteğe göre, YA-220 D Tavana vidayla sabitlenir,  
daha sonra ana kasaya, sıkı geçme takılır.  
Aydınlatma iki yönlüdür. Sarkıtta, YA 019 C,  
tavanı aydınlatır

YA-222 B  
Alm. Kızak Prf.



YA-207 D  
Tavan Askı Aparatı



Tekli KROM  
özel tel ölçüsü sipariş edilebilir-Standart tel: 1,5 mt

YA-207 D1  
Tavan Askı Aparatı



İkili KROM

YA-207 E2  
Askı Teli Tutucu



YA-220 T  
Alm. L Ken.Tapa

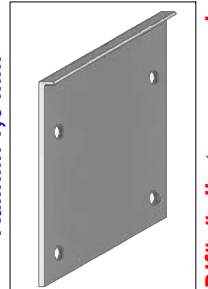

İstenilen renkte üretilir  
Kalınlık 1,5 mm

Difüzör ile tapa arasında,  
ışık sızdırmaz.

İSTENİLEN ÖLÇÜLERDE KESİM YAPILIR

All cutting dimensions can be done according to requirements

YA-223

Alm. Lineer Kasa

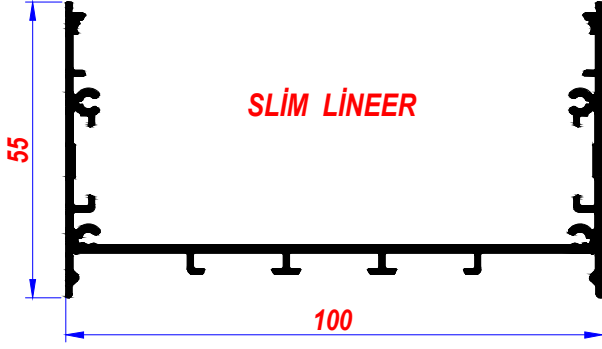

**İSTENİLEN RENKTE ÜRETİLİR**  
Kare, Dikdörtgen, Altgen gibi, çerçeve  
üretimine uygun ürün

YA-224 C

PC.Cam-Difüzör



YA-224 D

Alm. Prf. (Duvar Montaj)

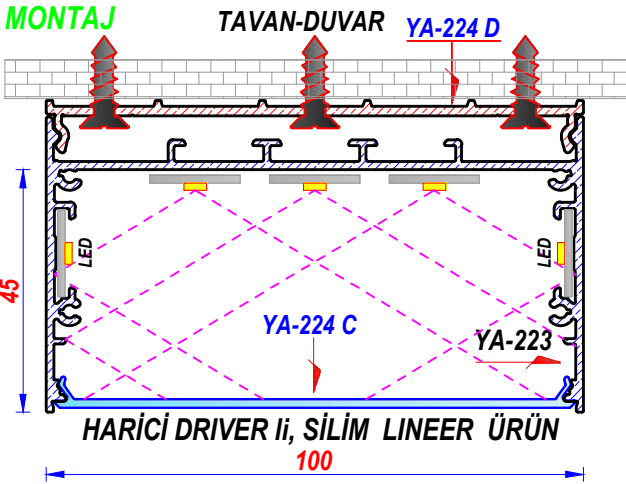
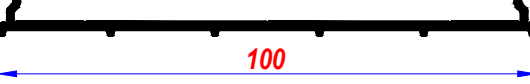

YA-224

Alm. Lineer Kasa

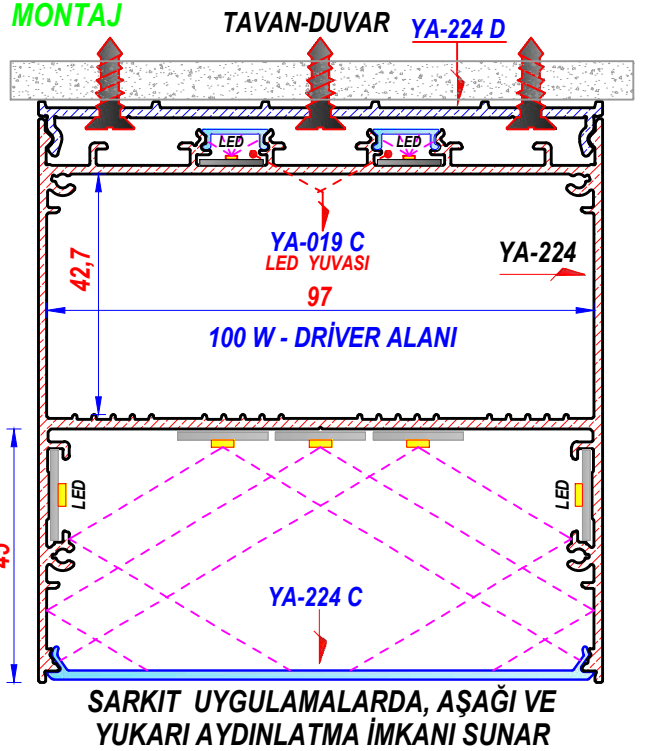
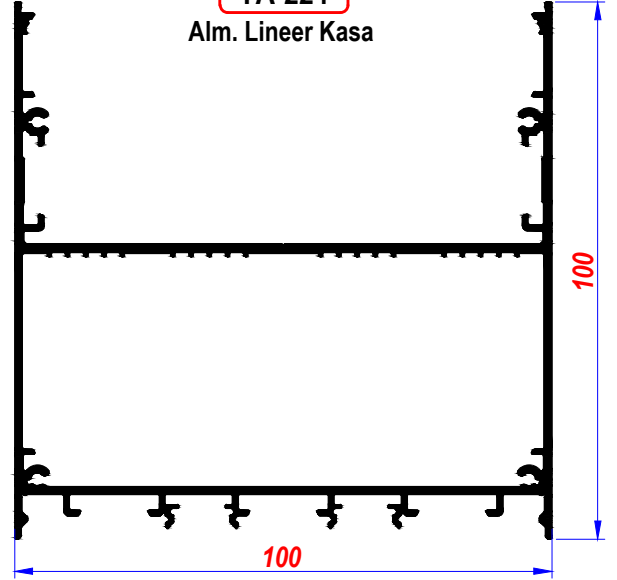

**İç mekan, askı aparatları ile sarkıt,  
Tavan ve duvara direkt vida ile sabitleyerek.  
isteğe göre, YA-224 D Tavana vidayla sabitlenir,  
daha sonra ana kasaya, sıkı geçme takılır.**

YA-223 T

Alm. L Ken.Tapa

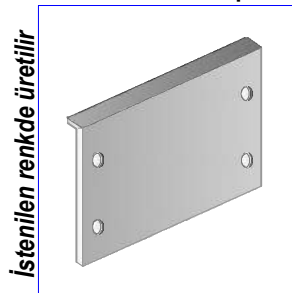

**DİFÜZÖR ile tapa arasında,  
ışık sızdırmaz.**

YA-019 C

PC.Cam-Difüzör



YA-207 D

Tavan Askı Aparatı



özel tel ölçüsü sipariş edilebilir-Standart tel: 1,5 mt

YA-207 D1

Tavan Askı Aparatı



YA-224 T

Alm. L Ken.Tapa

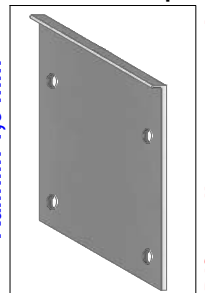

Lineer ürünlerde, Yeni L TAPA

**İSTENİLEN ÖLÇÜLERDE KESİM YAPILIR**

All cutting dimensions can be done according to requirements

YENİ

YA-214

Alm. Linear Kasa

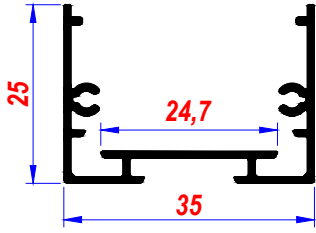

Ekonomik-Minik Linear Profil

YA-214

YA-1209 A

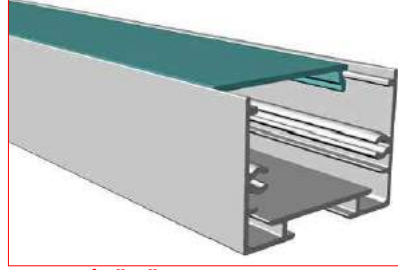

PC.DİFÜZÖR-ALM.PRF. 610 cm

YA-G 35 C

PC.Cam-Difüzör



Opal-Şeffaf

YA-214

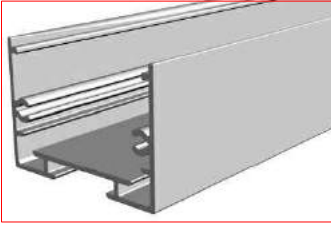

ALM. PRF. 610 cm

YA-214 T

Alm. L Ken.Tapa

İstenilen renkte üretilir  
Kalınlık 1,5 mm

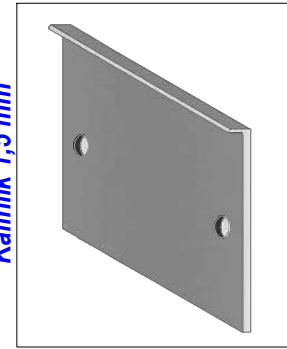

Difüzör ile tapa arasında,  
ışık sızdırmaz.

Linear ürünlerde, Yeni L TAPA

YA-207 D

Tavan Askı Aparatı



Tekli-Krom

YA-207 D1

Tavan Askı Aparatı



İkili-Krom

Standart tel uzunluğu 1,5 mt  
Özel tel ölçüsü sipariş edilebilir

YA-214 T Alm.Ken.Tapa, yeni üründür.  
Difüzör ile tapa arasında, ışık sızdırmaz.  
Düz tapaya göre, daha dekoratiftir.  
İstenilen renge boyanabilir

UYGULAMA ŞEKLİ;

İÇ MEKAN, ASKI APARATLARI İLE SARKIT,  
TAVAN-DUVARA VİDA İLE SABİTLEYEREK

MONTAJ

TEK SIRA LED UYGULAMASI

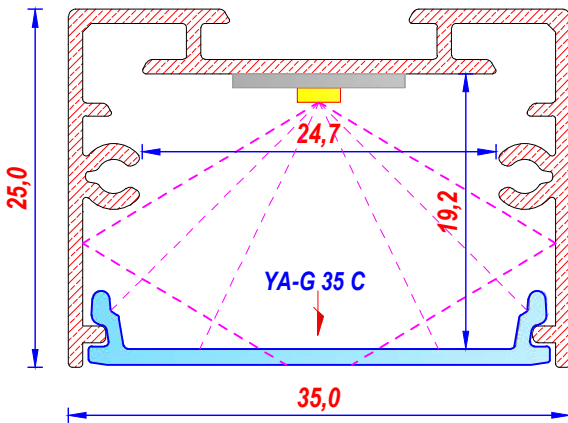

İKİ SIRA LED UYGULAMASI

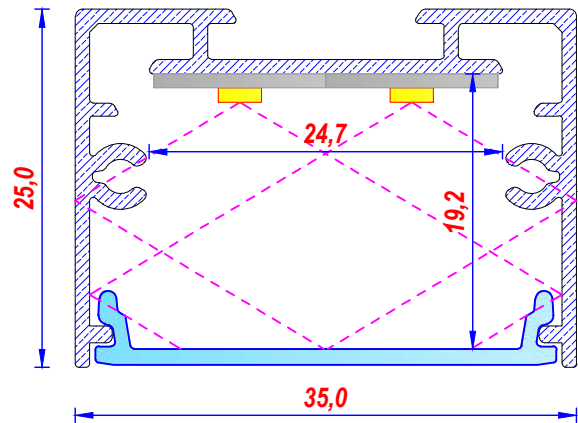

İSTENİLEN ÖLÇÜLERDE KESİM YAPILIR

All cutting dimensions can be done according to requirements

YA-213

Alm. Linear Kasa

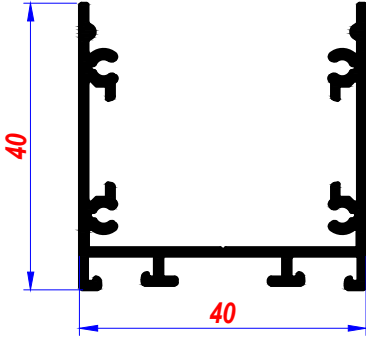

TAVAN MONTAJI KOLAY ÜRÜN  
İki farklı PC. Difüzör Seçeneği

YA-213 A

Alm. Prf. (Duvar Montaj)

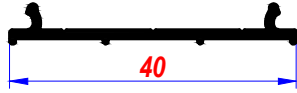

Kolay uygulanabilir, tavan-duvar  
montaj aparatı

Ürün 3 cm lik parçalar halinde kullanılabilir

YA-1209 A

P.C. Difüzör

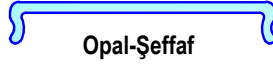

P.C. DİFÜZÖR 610 cm

YA-213 U

P.C. U Difüzör

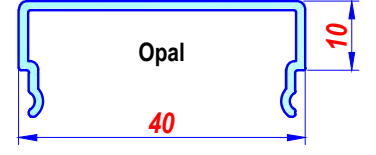

YA 213 U P.C. DİFÜZÖR 610 cm

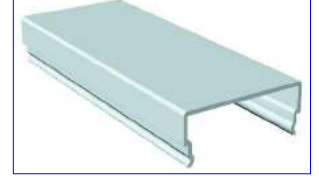

YA-213 L

Alm. L Ken.Tapa

İstenilen renkte üretilir  
Kalınlık 1,5 mm

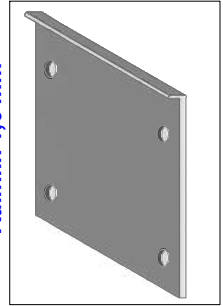

Difüzör ile tapa arasında,  
ışık sızdırmaz.

Lineer ürünlerde, Yeni L TAPA

YA-213 B

YA-213 B1

Alm.kenar tapa

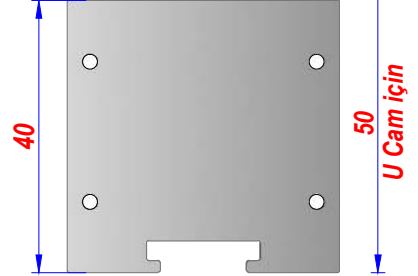

U Cam için, YA 213 B1  
Ken.Tapa Kullanılmalıdır

YA-207 D

Tavan Askı Aparatı



Tekli-Krom

YA-207 D1

Tavan Askı Aparatı



İkili-Krom

YA-207 E1

Yatay 90° Köşe-Metal



YA-207 E

Dikey 90° Köşe-Metal



YA-207 E2

Metal Askı Teli Tutucu



YA-1209 C

Alm. Kızak Prf.



Her iki camla birlikte tavan sarkıt olarak kullanılabilir  
İsteğe göre; YA-213 A, Tavan veya duvara vidayla sabitlenir  
Daha sonra ana kasa (YA-213 e), sıkı geçme takılır  
YA 213 A, ürünle birlikte kablo kanalı gibide kullanılır

### MONTAJ VE UYGULAMA ŞEKİLLERİ

YA-213 YA-213 A YA-1209 A

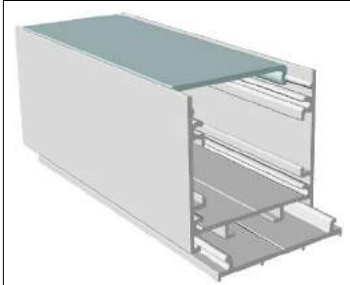

PC.DİFÜZÖR-ALM.PR.F. 610 cm

İSTENİLEN ÖLÇÜLERDE ÇERÇEVE YAPILIR  
45° AÇI İLE KESİLİP, KARE-DİKDÖRTGEN GİBİ  
DEKORATİF ŞEKİLLERDE ÇERÇEVE ÜRETİLEBİLİR

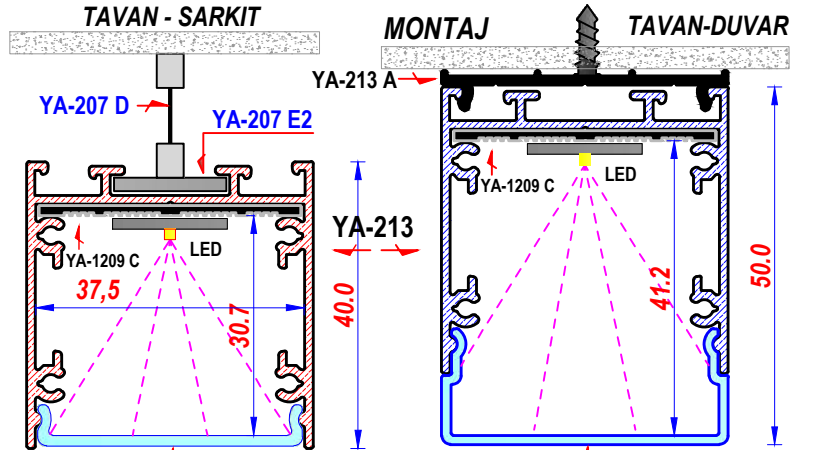

YA-213 PC DİFÜZÖR

YA-213 U PC DİFÜZÖR

İSTENİLEN ÖLÇÜLERDE KESİM YAPILIR

All cutting dimensions can be done according to requirements

YA-1209

Alm. Lineer Kasa

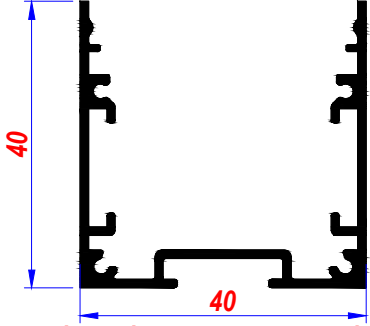

İSTENİLEN RENKDE ÜRETİLİR  
İki farklı PC. Difüzör Seçeneği

YA-1209 B

YA-1209 B1

Alm. Kenar tapa

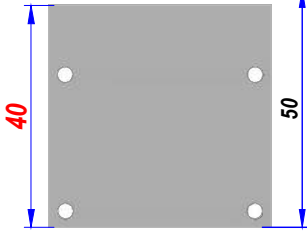

U Cam için

YA-1208 L

Alm. L Ken.Tp.

İstenilen renkte üretilir  
Kalınlık 1,5 mm

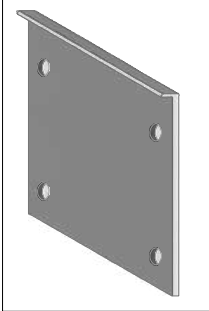

Difüzör ile tapa arasında,  
ışık sızdırmaz.

Lineer ürünlerde, Yeni L TAPA

YA-1209 A

P.C. Difüzör

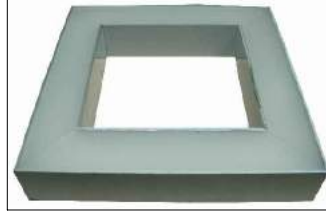
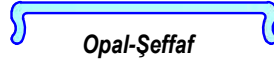

İSTENİLEN ÖLÇÜLERDE ÇERÇEVE YAPILIR

YA-213 U

P.C. U Difüzör

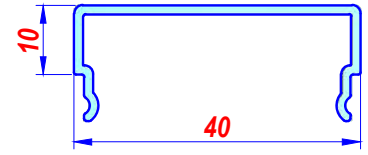

YA 213 U



P.C. DİFÜZÖR 610 cm

YA-1209 C

Alm. Kızak Prf.

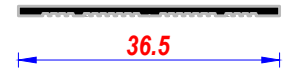

TAVAN - SARKIT



YA-207 D

YA-207 E2

MONTAJ VE UYGULAMA ŞEKİLLERİ

TAVAN-DUVAR

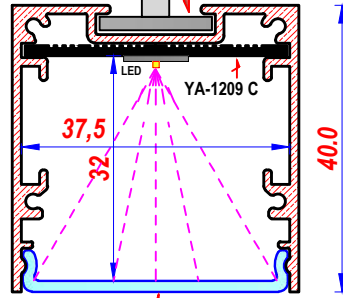

YA-213 PC DİFÜZÖR

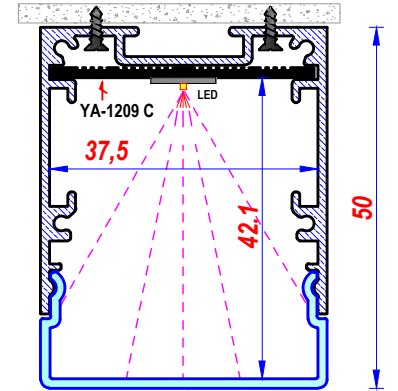

YA-213 U PC DİFÜZÖR

UYGULAMA ŞEKLİ;

İÇ MEKAN, ASKI APARATLARI İLE SARKIT,  
TAVAN-DUVARA VİDA İLE SABİTLEYEREK

YA-1209

PC-DİFÜZÖR-ALM.PRF. 610 cm

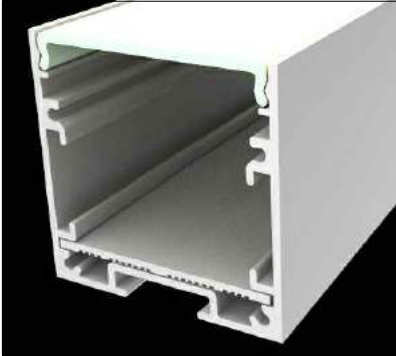

İSTENİLEN ÖLÇÜLERDE AÇILI VE DÜZ KESİM YAPILIR



45 DERECE AÇI İLE KESİLİP, KARE-DİKDÖRTGEN GİBİ  
DEKORATİF ŞEKİLLERDE ÇERÇEVE ÜRETİLEBİLİR

İSTENİLEN ÖLÇÜLERDE KESİM YAPILIR

All cutting dimensions can be done according to requirements

YA-1208

Alm. Lineer Kasa

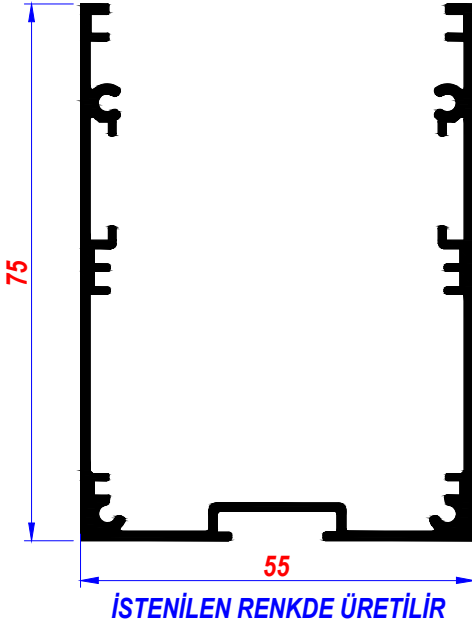

YA-1208 A

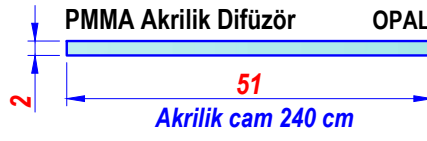

YA-1208 C



YA-1208 B

Alm. Düz Ken. Tp.

YA-1208 L

Alm. L Ken. Tp.

İstenilen renkte üretilir  
Kalınlık 1,5 mm

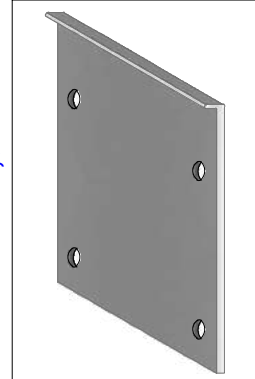

Lineer ürünlerde, Yeni L TAPA

YA-1208 L Alm. ken. tapa yeni üründür.  
Difüzör ile tapa arasında, ışık sızdırmaz.  
Düz tapaya göre, daha dekoratiftir.  
İstenilen renge boyanabilir

YA-207 D

Tavan Askı Aparatı



Tekli-Krom

standart tel uzunluğu 1,5 mt  
özel tel ölçüsü sipariş edilebilir

YA-207 D1

Tavan Askı Aparatı



İkili-Krom

YA-207 E

Dikey 90° Metal Köşe



YA-207 E1

Yatay 90° Metal Köşe



YA-207 E2

Metal Askı Teli Tutucu



UYGULAMA ŞEKLİ ;

İÇ MEKAN, ASKI APARATLARI İLE SARKIT,  
TAVAN-DUVARA VİDA İLE SABİTLEYEREK



KARE-DİKDÖRTGEN GİBİ DEKORATİF  
ŞEKİLLERDE ÇERÇEVE ÜRETİLEBİLİR

İSTENİLEN ÖLÇÜDE  
KARE - DİKDÖRTGEN  
ÇERÇEVE YAPILIR

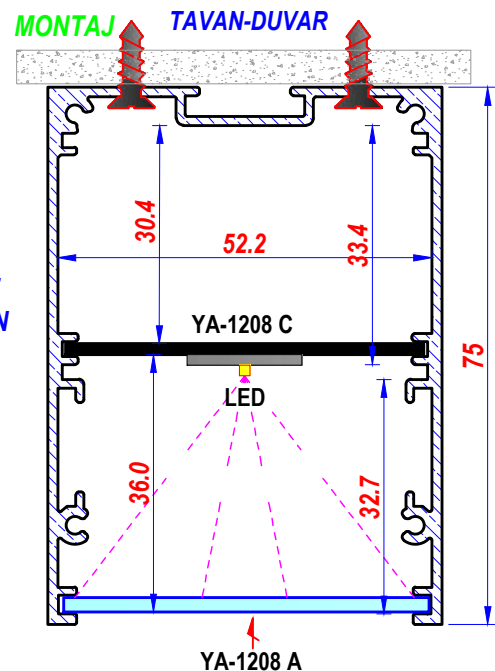

İSTENİLEN ÖLÇÜLERDE KESİM YAPILIR

All cutting dimensions can be done according to requirements

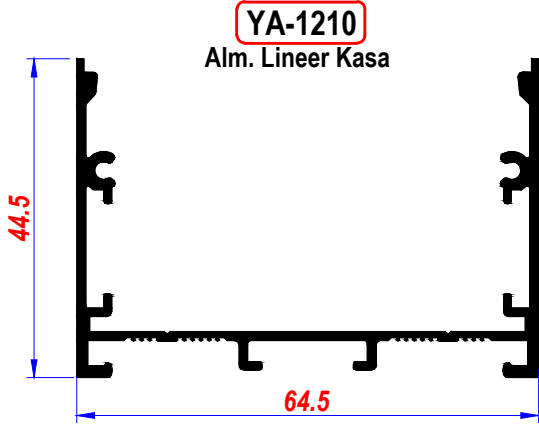

İSTENİLEN RENKDE ÜRETİLİR  
İSTENİLEN ÖLÇÜLERDE AÇILI VE DÜZ KESİM YAPILIR

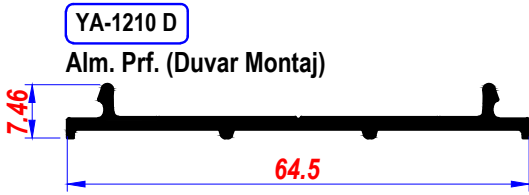

**UYGULAMA ALANLARI ;**

İÇ MEKAN, ASKI APARATLARI İLE SARKIT,  
TAVAN-DUVARA VIDA İLE SABİTLEYEREK

\* YA-1210 D kullanılmadan, Tavan veya duvara,  
vidayla sabitlenerek kullanılabilir  
İsteğe göre; YA-1210 D, Tavan veya duvara vidayla sabitlenir.  
Daha sonra ana kasa, sıkı geçme takılır

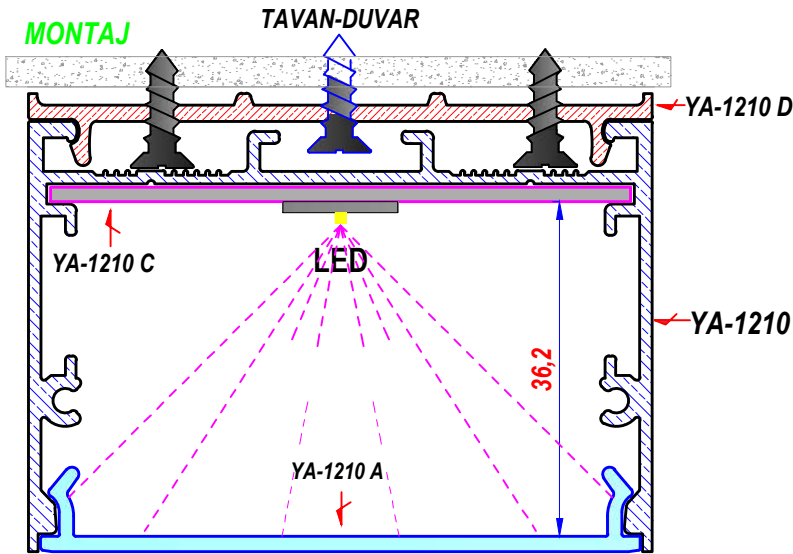

45 DERECE AÇI İLE KESİLİP, KARE-DİKDÖRTGEN GİBİ  
DEKORATİF ŞEKİLLERDE ÇERÇEVE ÜRETİLEBİLİR

İSTENİLEN ÖLÇÜLERDE KESİM YAPILIR

All cutting dimensions can be done according to requirements

**YA-1210 A**  
P.C. Difüzör

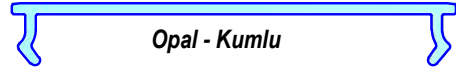

**YA-1210 B**  
Alm. Düz Ken. Tp.

**YA-1210 L**  
Alm. L Ken. Tp.

İstenilen renkte üretilir  
Kalınlık 1,5 mm

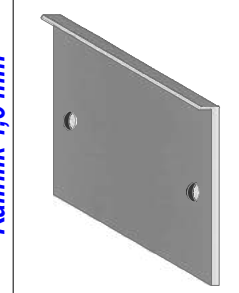

Difüzör ile tapa arasında,  
ışık sızdırmaz.

Lineer ürünlerde, Yeni L TAPA

**YA-1210 C**  
Alm. Kızak Prf.

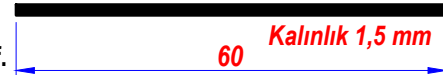

**YA-207 D** Tekli  
Tavan Askı Aparatı



**YA-207 D1** İkili  
Tavan Askı Aparatı



**YA-207 E**  
Dikey 90° Köşe-Metal



**YA-207 E1**  
Yatay 90° Köşe-Metal



**YA-207 E2**  
Metal Askı Teli Tutucu



**YA-1210**



İSTENİLEN ÖLÇÜLERDE ÇERÇEVE YAPILIR

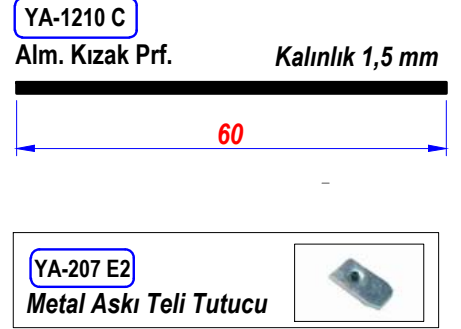
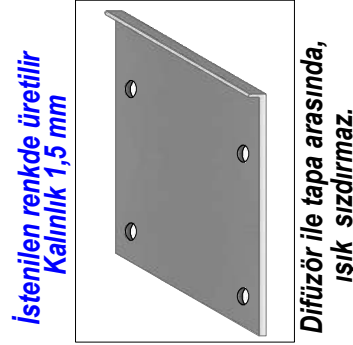
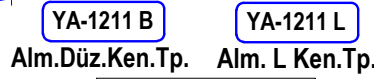
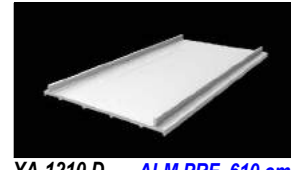
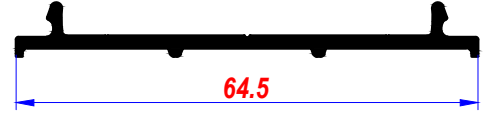
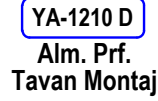
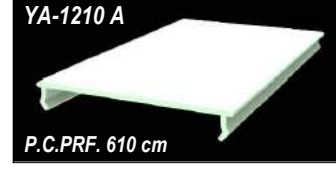
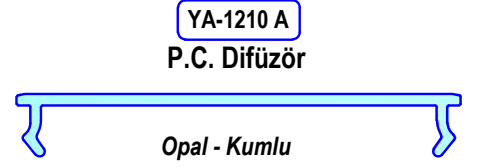
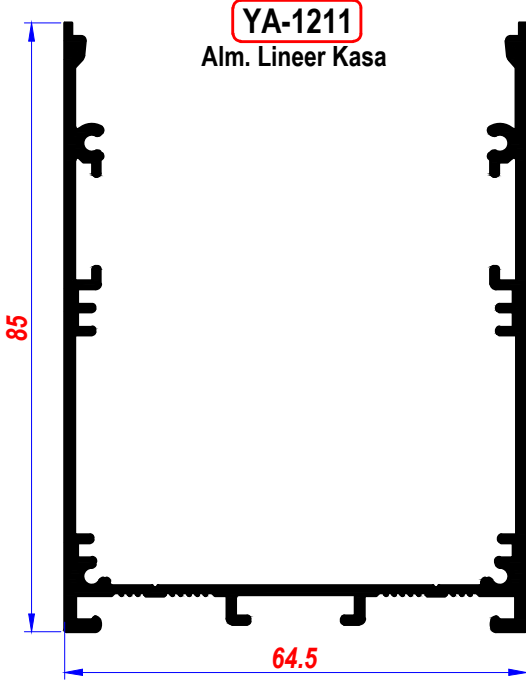

Lineer ürünlerde, Yeni L TAPA

UYGULAMA ALANLARI ;

İÇ MEKAN, ASKI APARATLARI İLE SARKIT,  
TAVAN-DUVARA VİDA İLE SABİTLEYEREK  
45 DERECE KESİLİP, 90 DERECE KARE-DİKDÖRTGEN  
GİBİ DEKORATİF ARMATÜRLER de ÜRETİLEBİLİR

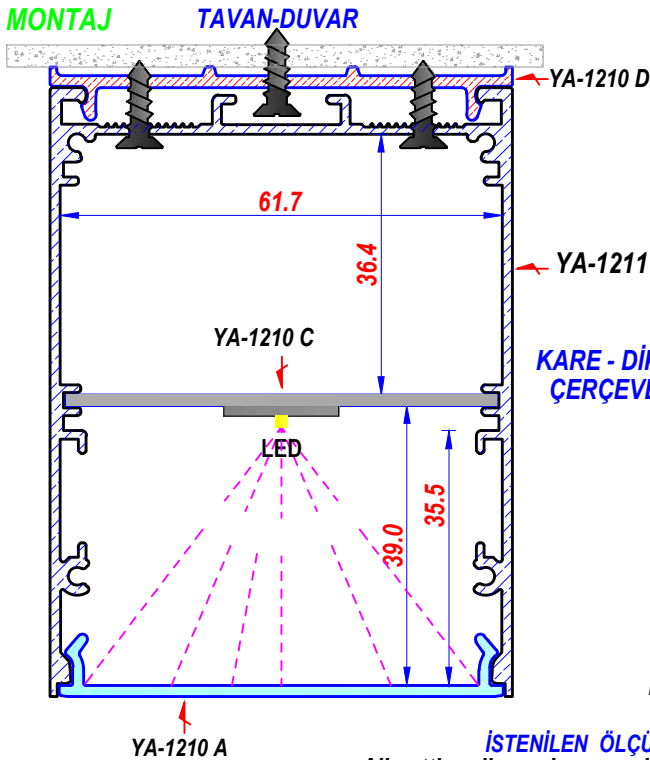

KARE - DİKDÖRTGEN  
ÇERÇEVE YAPILIR



YA-1210 D kullanılmadan, Tavan veya duvara,  
vidayla sabitlenerek de kullanılabilir  
İsteğe göre; YA-1210 D, Tavan veya duvara vidayla sabitlenir.

İSTENİLEN ÖLÇÜLERDE KESİM YAPILIR

All cutting dimensions can be done according to requirements

YENİ

YA - 225

Alm. Lineer Kasa  
Çok Noktadan Aydınlatma

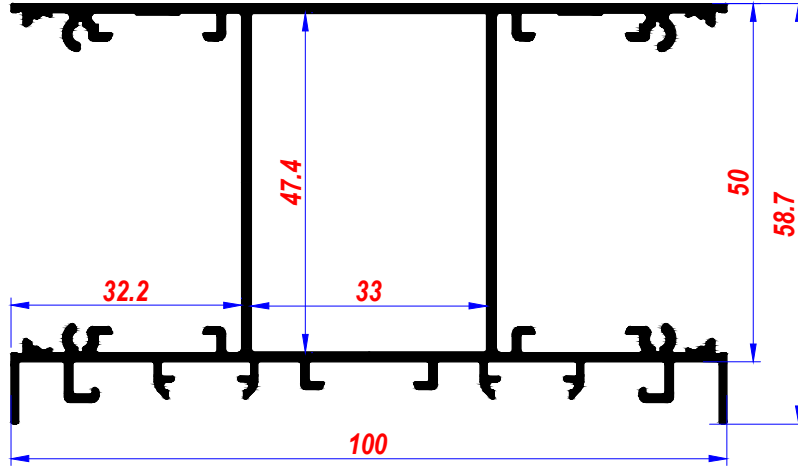

YA-G 50 A

PC.Cam-Difüzör

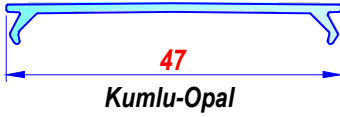

PC.Cam-Difüzör, üstten tatlı sıkı,  
takılıp çıkartılabilir

YA-209 D

Alm. Prf. (Tavan Montaj)

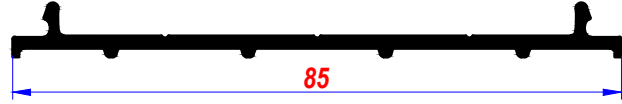

Alm.Profil 610 cm

YA-19 C

PC.Cam-Difüzör

11.4



Çizgili

Kumlu-Opal

YA-225 T

Alm. Ken.Tapa

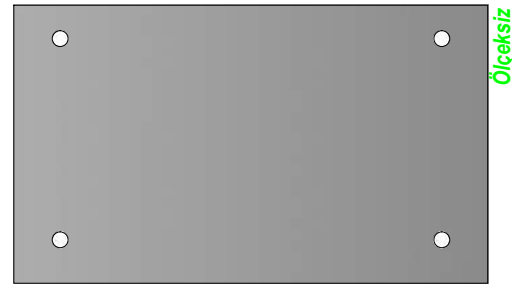

Alm. Lazer Kenar Tapa, 1.5 mm

UYGULAMA ALANLARI ;

İÇ MEKAN, ASKI APARATLARI İLE SARKIT,  
TAVAN-DUVARA VİDA İLE SABİTLEYEREK

Sarkit aydınlatma, dört noktadan  
Tavana montajda, iki noktadan  
Aydınlatmaya uygun, yeni ürün

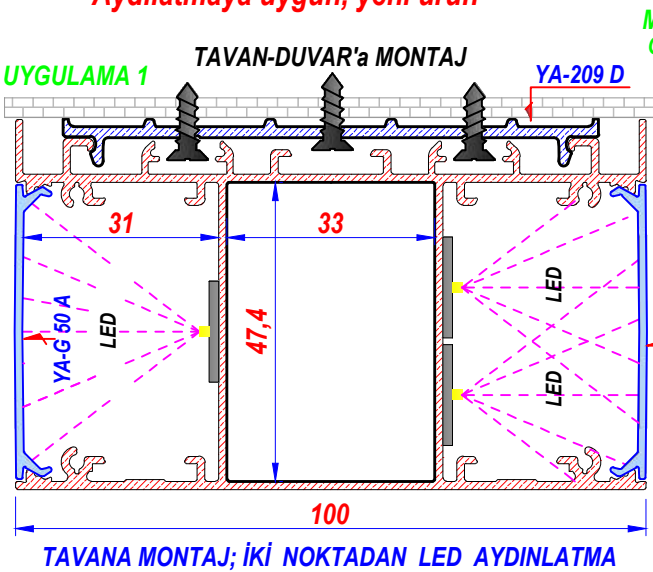

MONTAJ  
Ölçeksiz

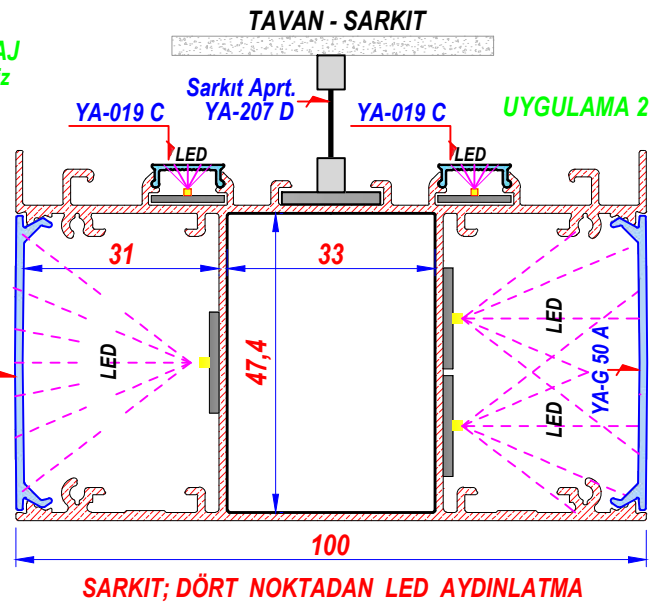

All cutting dimensions can be done according to requirements

YA-253 A

Büyük Ayak Seti  
Tek Vidalı

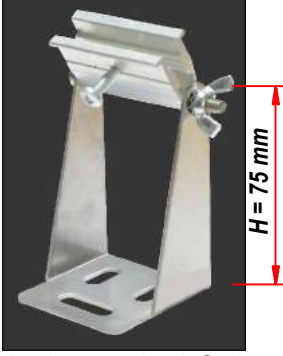

Paslanmaz Ayak Seti  
Kalinlik 1,5 mm

YA-253 B

Küçük Ayak Seti  
Tek Vidalı

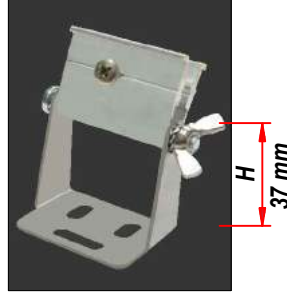

Paslanmaz Ayak Seti  
Kalinlik 1,2 mm

YA-253 F

Özel Ayak Seti  
Tek Vidalı



Paslanmaz Ayak Seti  
Kalinlik 1,5 mm

YA-253 M

Minik Ayak Seti  
Tek Vidalı

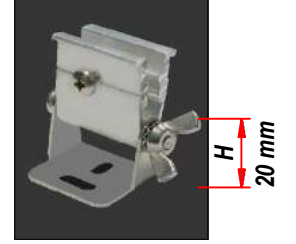

Paslanmaz Ayak Seti  
Kalinlik 1 mm

YA-253 C

Lüks Kç. Ayak Seti  
İki Vidalı

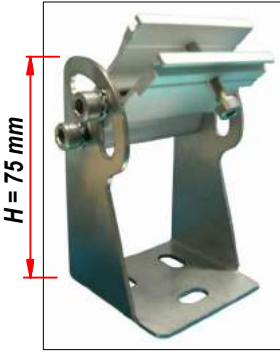

Paslanmaz Ayak Seti  
Kalinlik 1,5 mm

YA-253 D

Lüks Orta Ayak Seti  
İki Vidalı

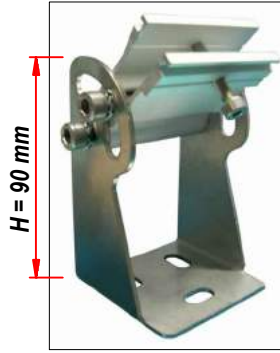

Paslanmaz Ayak Seti  
Kalinlik 1,5 mm

YA-253 D 1

Lüks By. Ayak Seti  
İki Vidalı

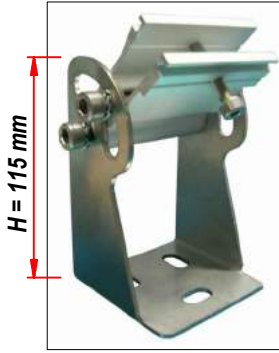

Paslanmaz Ayak Seti  
Kalinlik 1,5 mm

YA-253 E

Lüks By. Ayak Seti  
İki Vidalı

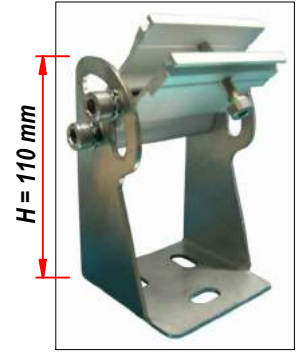

Paslanmaz Ayak Seti  
Prj. Kasalarına uygun  
Kalinlik 2mm

YA-253 L

L KOL  
Uzatma Aparatı

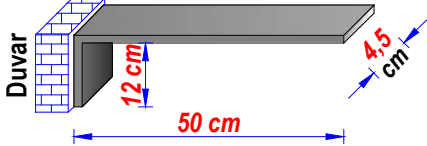

WW - Uzatma Aparatı  
Kalinlik 3 mm - Uzunluk 50 cm  
A. Gri - Elk. Stk. Toz Boyalı

YA-253 L 1

L KOL  
Uzatma Aparatı

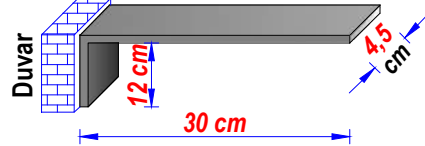

WW - Uzatma Aparatı  
Kalinlik 3 mm - Uzunluk 30 cm  
A. Gri - Elk. Stk. Toz Boyalı

YA-253 L 2

L KOL  
Uzatma Aparatı

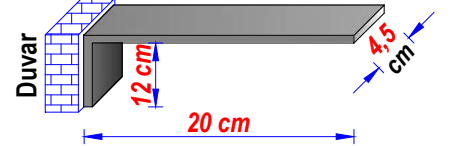

WW - Uzatma Aparatı  
Kalinlik 3 mm - Uzunluk 20 cm  
A. Gri - Elk. Stk. Toz Boyalı

Renk A.Gri

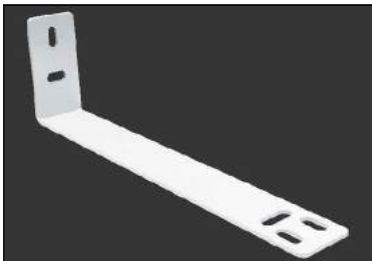

Renk A.Gri

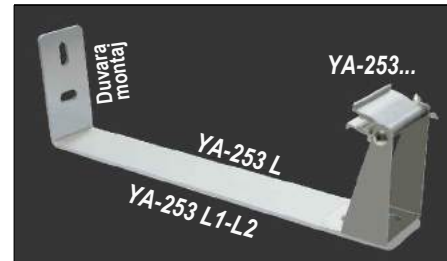

YA-253 L - YA-253 L1 - YA-253 L2

L AYAK ve AYAK SETİNİN MONTAJI



IP 66 WW

YA-254

Alm. WW Kasa  
Duvlar Boyama

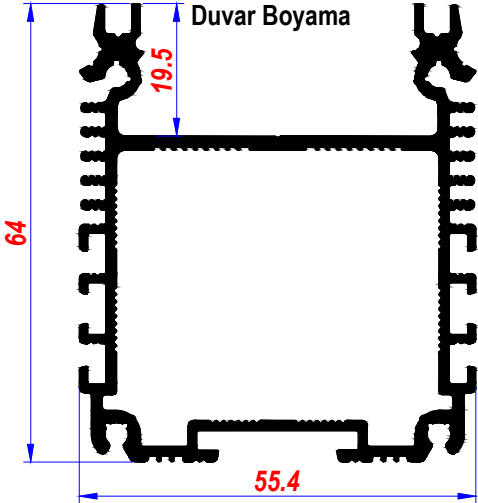

IP 66 UYGUN, WW ALM. PRF.

YA-254 A

Polikarbon Cam

PC.Cam(Coeks)Gri-Őef. 610 cm



YA-254 C

Elastron fitil



PC. Cam Fitili  
Renk:A.Gri

YA-254

YA-254 A

YA-254 C



ALM. PRF. - P.C. CAM 610 cm

YA-254 B

Pls.Kenar Tapa + Conta

Renk:A.Gri



Cam takviyeli polyamid

M 4 X 14 IMBUS VIDA KULLANILMALIDIR

YA-L1

Polikarbon lens



Lens açısı 45°

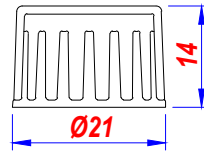

LENS; Duvlar boyama(ww), projektör ve sokak  
armatür kasalarında kullanıma uygundur...

YA-254 ALM. PRF. ve AKSESUARLARI



IP 66 ya uygun yeni wallwasher ürün

Yeni nesil dekoratif UV katkılı Polikarbon cam ( Coeks )  
Sızdırmaz fitil, cam takviyeli kenar tapa

MONTAJ

YA-254 A

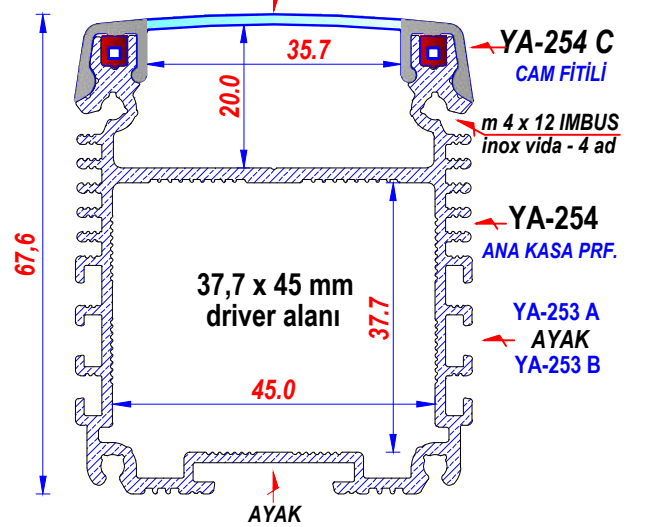

37,7 x 45 mm lik geniş driver alanı

3 noktadan ayak takma yeri ( Sağ-sol-alt )  
DEKORATİF, CAM TAKVİYELİ PLS. KENAR TAPA

İSTENİLEN ÖLÇÜLERDE KESİM YAPILIR

All cutting dimensions can be done according to requirements

YA-255

Alm. WW Kasa (Küçük)

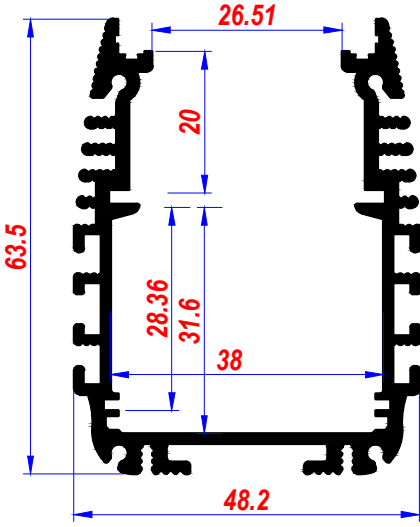

EKONOMİK ÇOK SATAN ÜRÜN

YA-255 A

Alm.İç Kızak Prf.

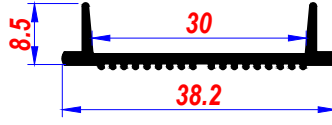

IP 65 e UYGUN ÜRÜN  
CAM TAKVİYELİ POLYAMİD  
PLASTİK KENAR TAPA  
İSTENİLEN ÖLÇÜLERDE TEMPERLİ CAM  
3 NOKTADAN AYAK TAKMA YERİ  
sağ-sol-alt

YA-255 B

Pls. Ken. Tapa+Conta

Renk:A.Gri



Cam takviyeli polyamid  
m 3 x 12 x 4 ad. imbus vida

YA-253 A

Büyük Ayak Seti



Paslanmaz Ayak Seti

YA-253 B

Küçük Ayak Seti



YA-255 D

PG - 7

Polyamid Rakor-IP 68



Wallwasher - Projektör  
Kasalarına uygun

YA-255 D 1

PG - 9

Polyamid Rakor-IP 68

YA-255 E

PG - 7

Metal Rakor-IP 68



Wallwasher - Projektör  
Kasalarına uygun

YA-255 E 1

PG - 9

Metal Rakor-IP 68

YA-255 PV

Polyamid

Havalandırma Ventili



Wallwasher - Projektör  
Kasalarına uygun

YA-255 MV

Metal

Havalandırma Ventili



Wallwasher - Projektör  
Kasalarına uygun

H = 76 mm

H = 37 mm

- İSTENİLEN ÖLÇÜLERDE TEMPERLİ CAM
- PROFİLE UYGUN AYAK SETİ ; YA-253 A, YA-253 B, YA 253 C
- FARKLI ÖLÇÜLERDE TEK-ÇİFT VİDALI PASLANMAZ AYAK SETİ

YA-255  
YA-255 A



PRF. 610 cm

Farklı ölçülerde tek-çift vidalı ayak seti mevcut

MONTAJ YA-255



3 NOKTADAN AYAK TAKILABİLİR  
SAĞ - SOL - ALT

İSTENİLEN ÖLÇÜLERDE KESİM YAPILIR

All cutting dimensions can be done according to requirements

YD-003

Alm. WW Kasa (Orta)

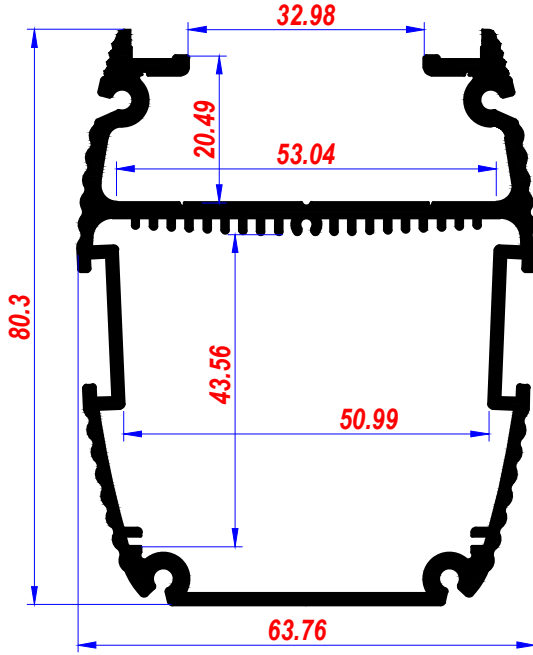

IP 65 e UYGUN ÜRÜN  
İSTENİLEN ÖLÇÜLERDE TEMPERLİ CAM

MONTAJ



2 NOKTADAN ( SAĞ -SOL ) AYAK TAKILABİLİR

YD-003 A

PLS. Ken.Tapa + Conta  
Cam Takviyeli Polyamid

Renk : A.Gri

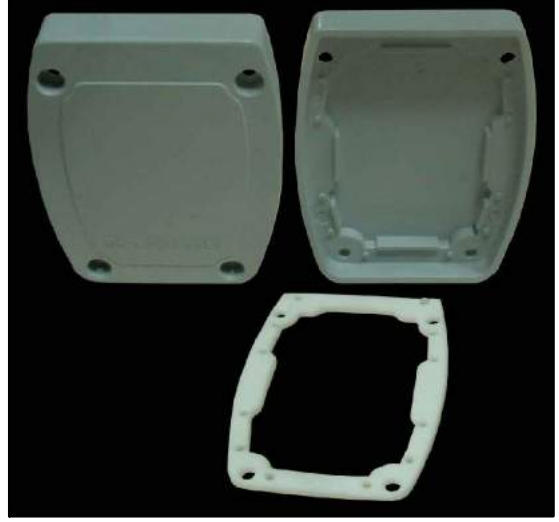

M 4 X 14 IMBUS VİDA KULLANILMALIDIR

- İSTENİLEN ÖLÇÜLERDE TEMPERLİ CAM
- PROFİLE UYGUN AYAK SETİ ; YA-253 D
- FARKLI ÖLÇÜLERDE TEK-ÇİFT VİDALI PASLANMAZ AYAK SETİ

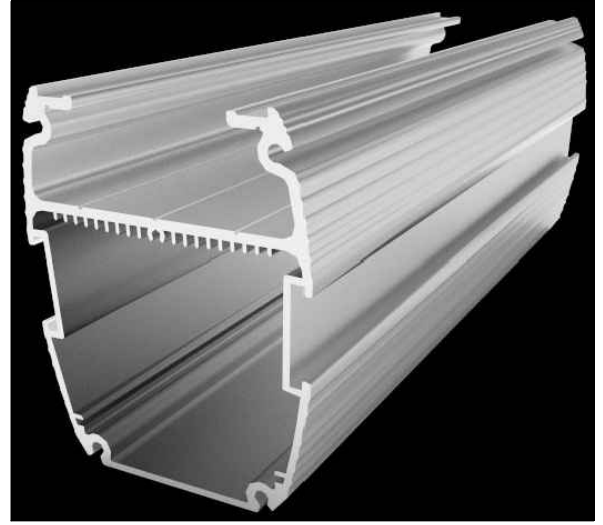

PRF. 610 cm

YD - 003

YA-255 D

PG - 7

YA-255 D 1

PG - 9



Polyamid Rakor - IP 68



Metal Rakor-IP 68

YA-255 E

PG - 7

YA-255 E 1

PG - 9



İSTENİLEN ÖLÇÜLERDE KESİM YAPILIR

All cutting dimensions can be done according to requirements

YD-004

Alm. WW Kasa (Büyük)

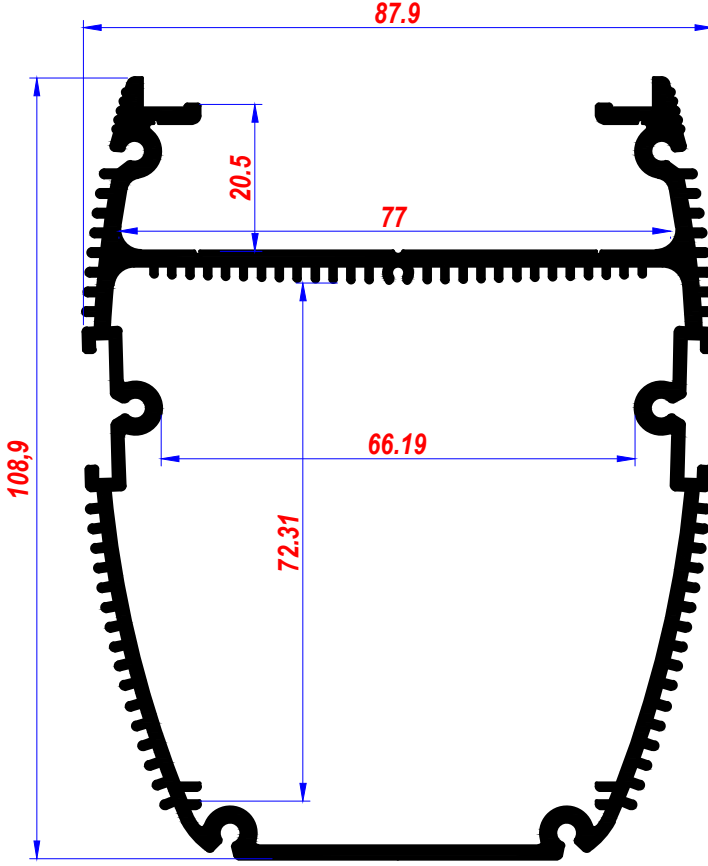

## İKİ SIRA LED İÇİN UYGUN KASA

YD-004 A

PLS. Ken.Tapa + Conta  
Cam Takviyeli Polyamid

Renk : A.Gri



M 4 X 10 IMBUS VİDA KULLANILMALIDIR

IP 65 e UYGUN ÜRÜN  
FİRMA İSMİ İÇİN ETİKET YUVASI  
İSTENİLEN ÖLÇÜLERDE TEMPERLİ CAM  
DEKORATİF CAM TAKVİYELİ, PLS. KENAR TAPA

MONTAJ YD - 004



2 NOKTADAN ( SAĞ - SOL ) AYAK TAKILABİLİR



2 NOKTADAN ( SAĞ - SOL ) AYAK TAKILABİLİR

- İSTENİLEN ÖLÇÜLERDE TEMPERLİ CAM
- PROFİLE UYGUN AYAK SETİ ; YA-253 D1
- Farklı ölçülerde tek - çift vidalı ayak seti mevcut

YA-255 D YA-255 D 1  
PG - 7 PG - 9  
Polyamid Rakor - IP 68

YA-255 E YA-255 E 1  
PG - 7 PG - 9  
Metal Rakor - IP 68

İSTENİLEN ÖLÇÜLERDE KESİM YAPILIR

All cutting dimensions can be done according to requirements

ALÜMİNYUM EKSTRÜZYON DUVAR BOYAMA WW - SOKAK ARMATÜRÜ  
POLİKARBON DİFÜZÖR

YA-265

Alm. WW Kasa  
Sokak Arm.Kasa

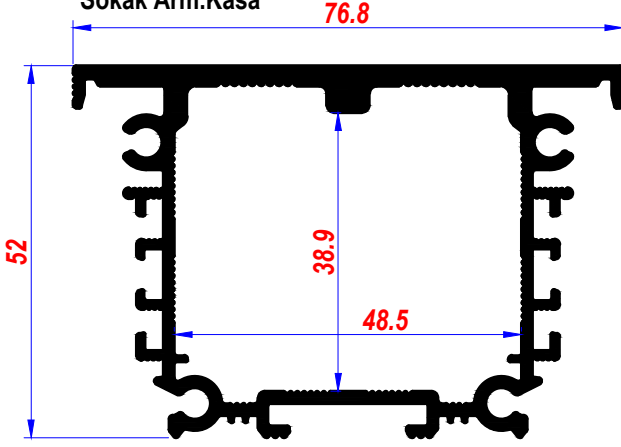

IP 66, SOKAK ARM.-DUVAR BOYAMA KASASI

IP 66 KORUMALI, PC ENJ. DİFÜZÖRLÜ, YENİ EKONOMİK  
DUVAR BOYAMA ve SOKAK ARMATÜR KASASI

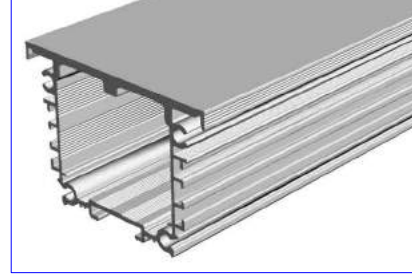

ALM. PRF. 610 CM

YA-265 T

Pls.Ken.Tapa + Conta



Sonlandırma Tapası

YA-1203 D

Duvar Bağlt. Aprt.



PASLANMAZ KLİPS - ÇELİK

YA-265 P

Enj. PC.Difüzör+Conta



Gen. 75,5 mm-Uz. 350 mm-H=22,5 mm  
PCB ALANI ; 50 mm x 315 mm

Üç noktadan ayak takabilme  
Çift sıra led kullanımına uygun  
Park, site içi, dekoratif sokak armatürü  
Daha geniş driwer alanı

ALM. WW - DUVAR BOYAMA KASASI

PC DİFÜZÖR 35 CM



PC DİFÜZÖR YAN YANA, ÇOKLU UYGULANABİLİR

PC DİFÜZÖR 35 CM



YA-265 S SOKAK ARMATÜR KASASI

YA-265 UT

Pls.U Mafsall Tapası+Conta

Mafsall Bağlantı Tapası



TAVAN - DUVARA, 2 FARKLI  
KLİPSLE, MONTAJI YAPILABİLİR

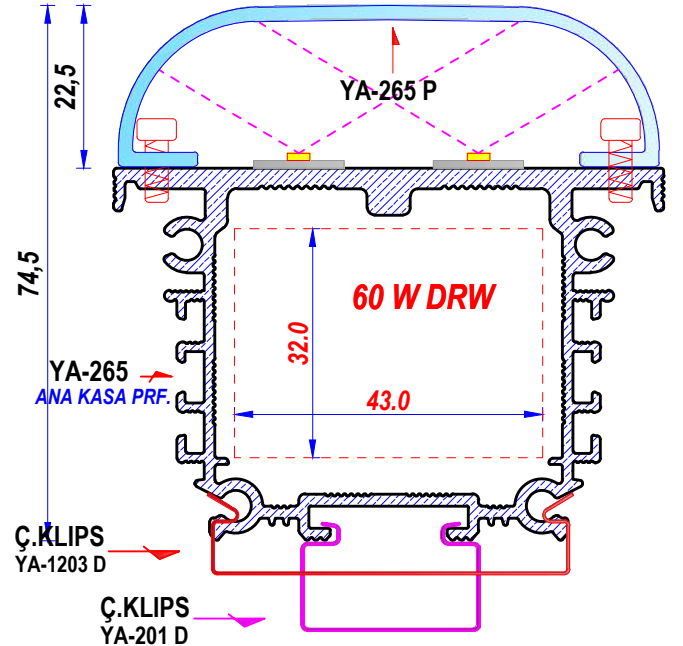

YA-266

Alm. WW Kasa

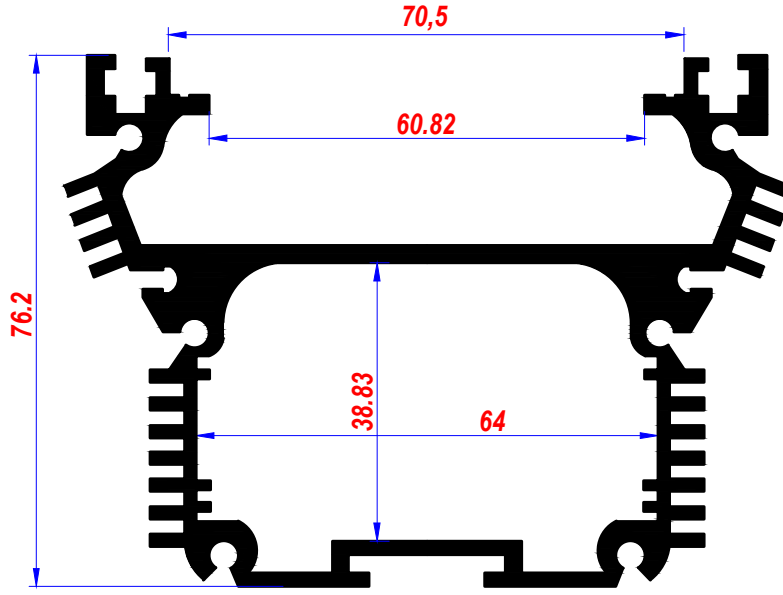

YA-301 D

Alm. Cam Çıta Prf.  
İŐlenmiŐ-vida(Setli)



YA-251 C

Cam Fiteli



YA 251-258-266 Uyumlu

YA-266 A

Alm.Metal.Tapa+Conta  
Cam Çıtasına Uygun



TalaŐlı imalat

YA-266 B

Plastik Tapa + Conta  
Cam çıtasız



YA-266 D

P.C. Tapa + Conta  
Cam çıtalı

YA-266 C

Alm.Metal Tapa+Conta  
Zamak Enj. (Cam çıtalı)



İŐTENİLEN ÖLÇÜLERDE KESİM YAPILIR

All cutting dimensions can be done according to requirements

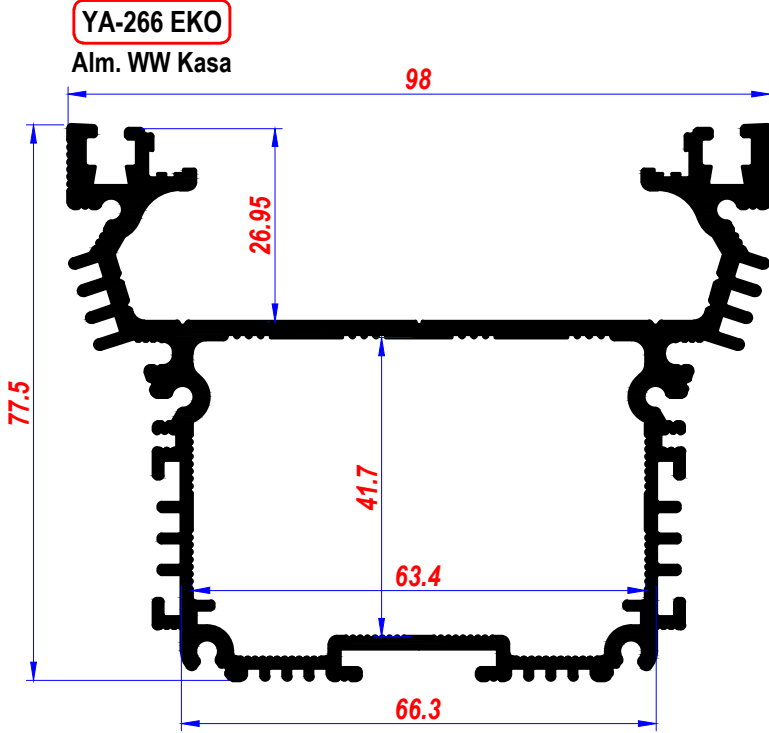

- Benzerlerinden daha ekonomik
- Yeni silikon cam fitili
- Üç noktadan ayak takabilme
- Çift sıra led kullanımına uygun
- Daha geniş driver alanı
- Dekoratif-slim Sokak Armatürü

**YA-266 F** Alm. WW Kasa  
Sokak Armatürü

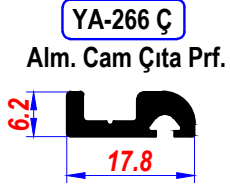

Fitil, cam çitasına takılıyor

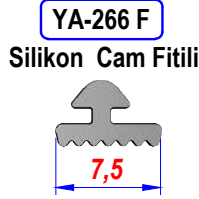

**YA-255 PV** Polyamid  
**YA-255 MV** Metal  
Havalandırma Ventili



Wallwasher - Projektör  
Kasalarına uygun

**YA-266 M**  
Metal Direk  
Mafsalı



**YA-266 B 1**  
Pls.Kenar Tapa + Conta  
Renk:A.Gri



Cam çita profiliyle birlikte kullanılır

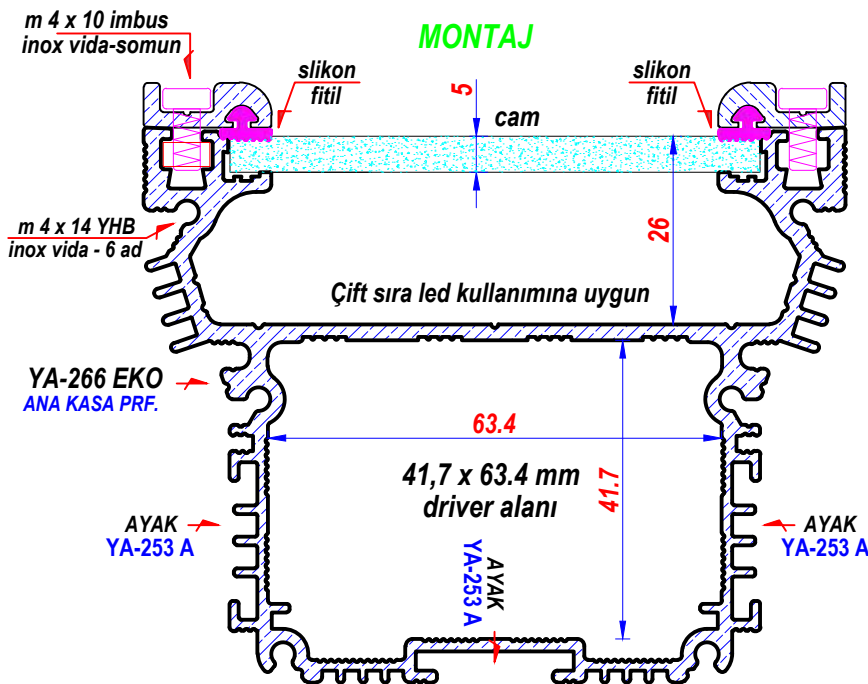
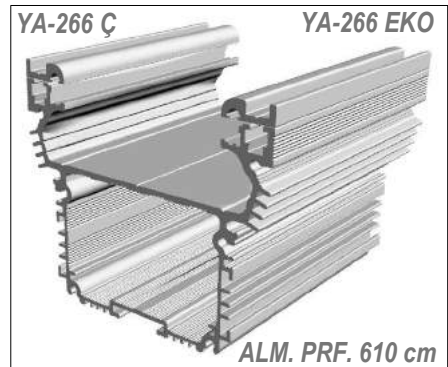

İSTENİLEN ÖLÇÜLERDE KESİM YAPILIR

All cutting dimensions can be done according to requirements

YA-267

Alm. WW Kasa

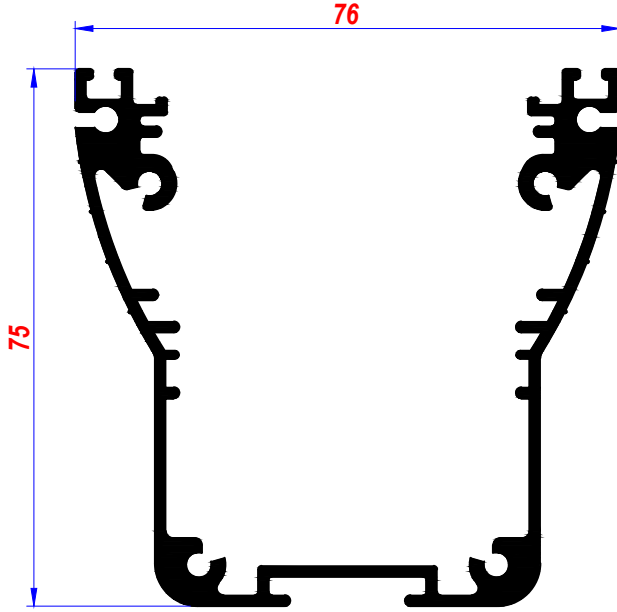

YA-269

Alm. ww Prf.

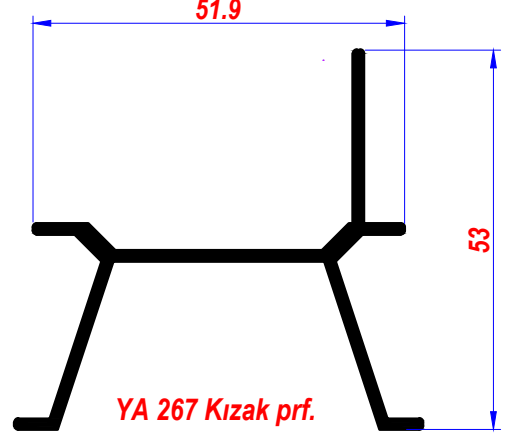

YA-267 B

Pls. Tapa + conta  
Cam çitasız



YA-267 A

Metal Tapa+conta  
Alm.Enj.(Cam çitalı)



YA-301 D

Alm.Cam Çita Prf.



YA-251 C

Fitil



YA 251-258-266-267 Uyumlu

YA-267 C

Metal Tapa + conta  
Zamak-cam çitalı



Cam çita profiliyle birlikte kullanılır

WW-DUVAR BOYAMA UYGULAMASI



MONTAJ

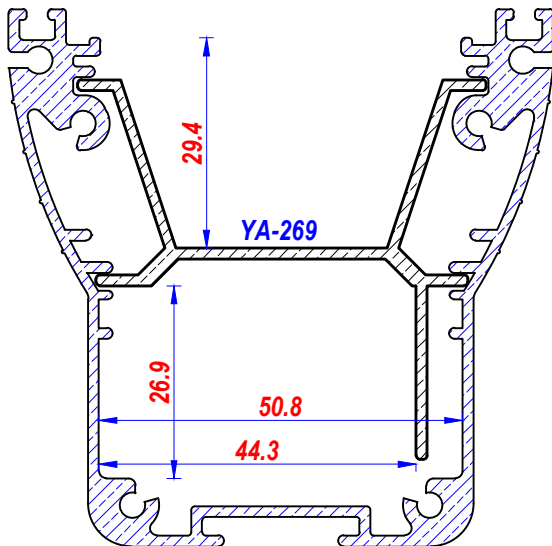

İSTENİLEN ÖLÇÜLERDE KESİM YAPILIR

All cutting dimensions can be done according to requirements

ALM. ENJEKSİYON SOKAK ARMATÜRÜ

YA-309

Sokak Arm. Kasa (Enj.)

50 - 75 W

54 Ledli

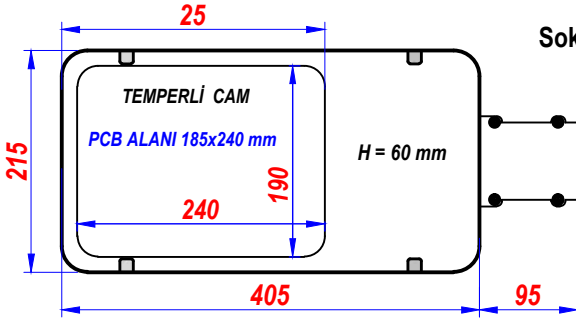

IP 65 PCB alanı : 185 x 240 mm

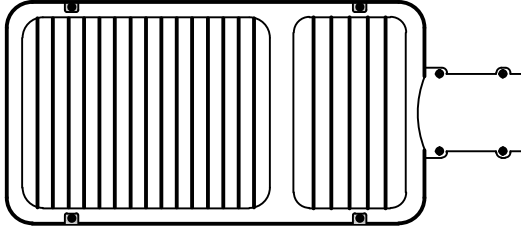

ALM. ENJEKSİYON PROJEKTÖR KASASI

YA-312

Projektör Kasası (Enj.)

50 - 75 W

54 Ledli

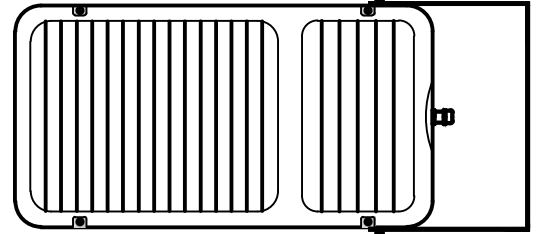
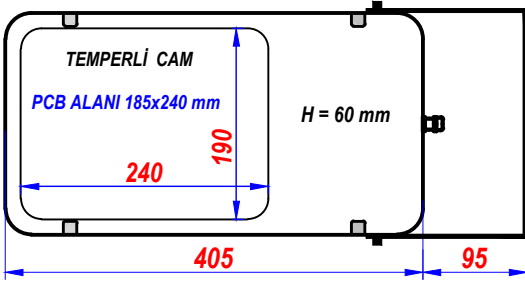

IP 65 PCB alanı : 185 x 240 mm

ALM. ENJEKSİYON KANOPI KASASI

YA-320

Kanopi Kasası

Yüksek soğutmaya sahip,ÜRÜN

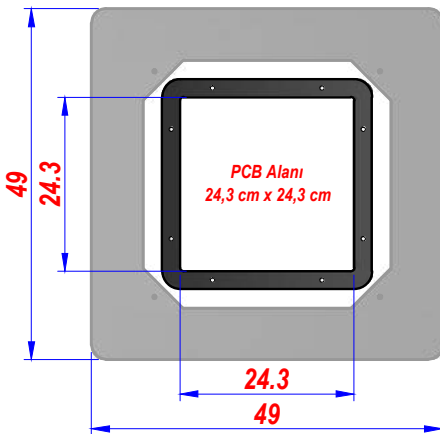

100 W KANOPI

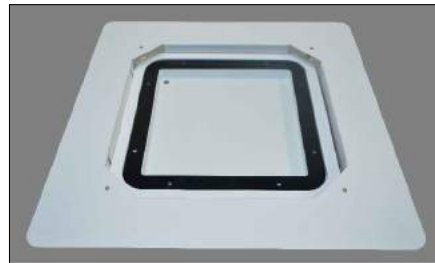

Alm.Enj.Kasa ve 1,5 mm sac

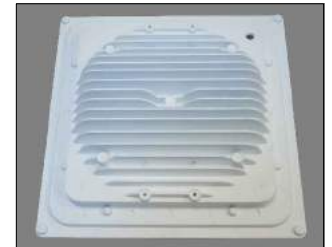

Üründe 4 mm cam kullanılır

İSTENİLEN ÖLÇÜLERDE KESİM YAPILIR

All cutting dimensions can be done according to requirements

ALM. ENJEKSİYON SOKAK ARMATÜRLERİ

YA-314

Sokak Arm. Kasa (Enj.)

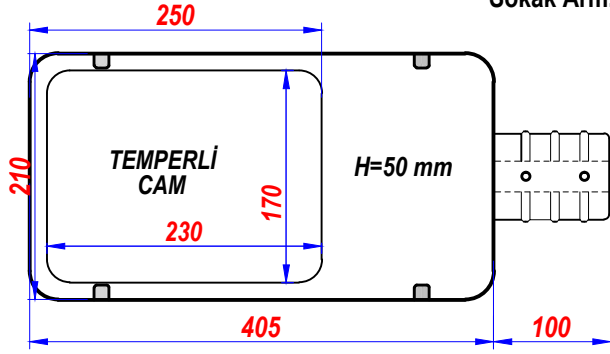

IP 66 - 100 W

IP 66 - 100 W



KASA RENGİ - AÇIK GRİ

IP 66 - 100 W

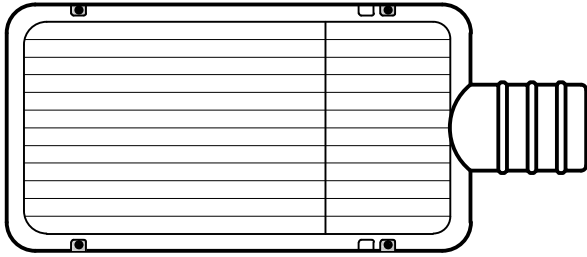

PCB Alanı : 170 x 230 mm

DRIVER Alanı : h=45,5 x 100x175 mm

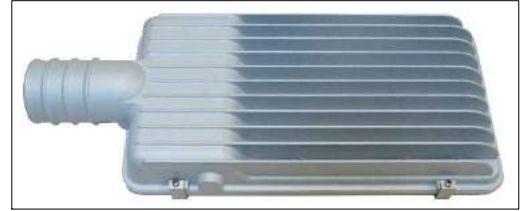

Müşteriye özel, PCB ve LED dizgi tasarımı yapılır

ALM. ENJEKSİYON PROJEKTÖR KASASI

YA-314 A

Projektör Kasası (Enj.)

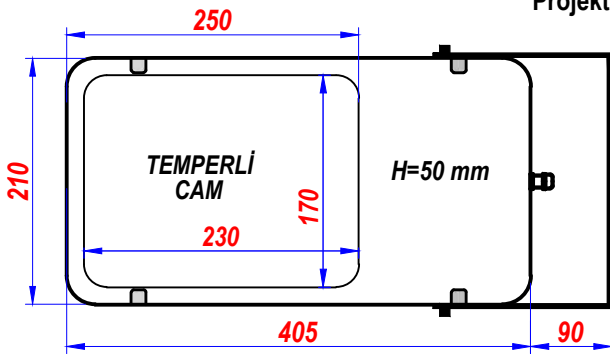

IP 66 - 100 W

IP 66 - 100 W



KASA RENGİ - SİYAH

IP 66 - 100 W

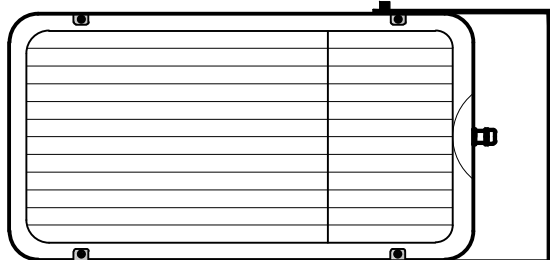

PCB Alanı : 170 x 230 mm

DRIVER Alanı : h=45,5 x 100x175 mm



Müşteriye özel, PCB ve LED dizgi tasarımı yapılır

İSTENİLEN ÖLÇÜLERDE KESİM YAPILIR

All cutting dimensions can be done according to requirements

YA-301

Alm.Led Prj.Kasa  
Ekstrüzyon

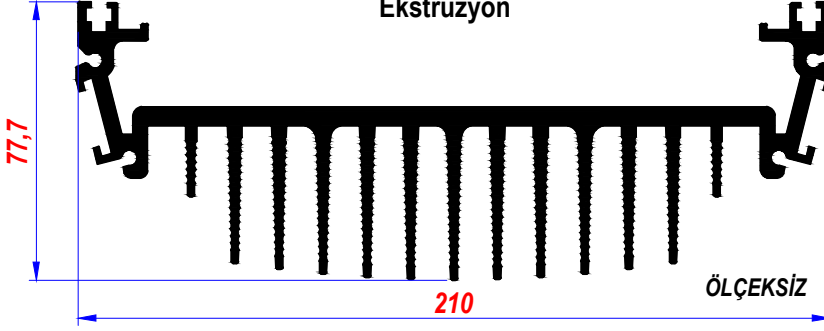

YA-301 A

Kenar kapak (Alm.Enj.) + Conta



YA-388

Drv.Kutu Prf.

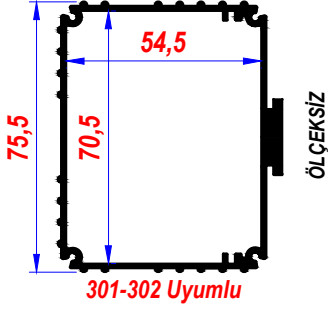

YA-388 A

Drv.Kutu Tapası-Alm.

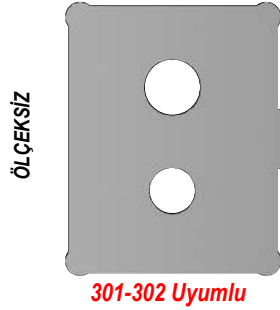

YA-301 E

Cam Fitili



YA-301 B

Kenar Kapak (Metal-İşlenmiş Alm.)



YA-302

Alm.Led Prj.Kasa  
Ekstrüzyon

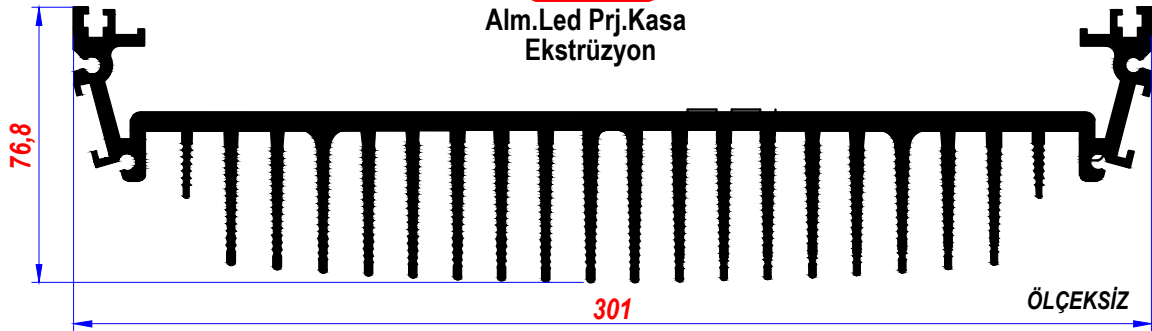

YA-302 A

Kenar kapak (Alm.Enj.) + Conta



YA-301 C

Alm.Cam Çıta Prf.



YA-301 D

Alm.Cam Çıta Prf.  
İşlenmiş-vida(Setli)



YA-302 B

Kenar kapak (Alm.Enj.)



İSTENİLEN ÖLÇÜLERDE KESİM YAPILIR

All cutting dimensions can be done according to requirements

ALÜMİNYUM EKSTRÜZYON PROJİKTÖR-SOKAK ARMATÜRÜ  
POLİKARBON DİFÜZÖR

YA-1310

Alm.Led Prj.Kasa  
PC. Enj.Difüzör  
50-75 Watt  
Pcb alanı:140x235 mm

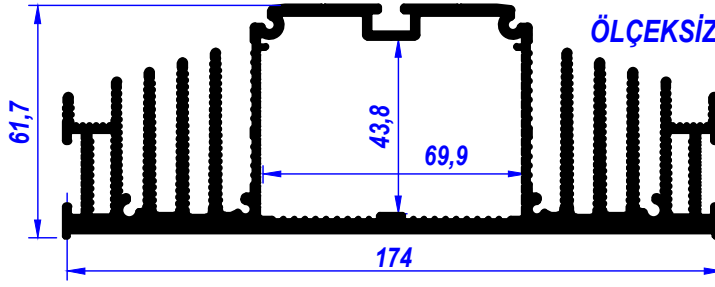

YA-1310 P

Projektör Kasası  
Takım

IP 66, 50-75 Watt

YA-1310 S

Sokak Arm. Kasa  
Takım

Pcb alanı:140x235 mm

YA-1310 P

Prjektör Kasa-Takım

IP 66 - 50-75 Watt



PC. Enj.Difüzör

GENŐ ;174 mm UZUN ;280 mm

- \* IP 66 korumalı, ekonomik PROJİKTÖR ve SOKAK armatürü
- \* Minimum ağırlık, kolay işçilik
- \* Geniş driver alanı ; 43,8 x 69,9 mm
- \* Pcb alanı ; 140 x 235 mm
- \* Kenar tapa, U ayak HRP sac 3 mm, açık gri, elektro statik toz boya
- \* Faturalı, elastron, sızdırmaz kenar tapa contası
- \* Kenar tapada sızdırmaz 2 Őer ad IP 66, 6 mm kör somun perçin uygulaması
- \* Yan yana 2 veya 3 sıra cam uygulama imkanı ; YA-1310 2 50 + 50 = 100 watt
- \* Ürünlerle birlikte, U ayak, veya direk Mafsalı,Ken. tapa,conta,inox vidalar, IP 68 PG 7 metal rakor gönderilir.
- \* Alüminyum Profil uzunluđu, 400 cm dir
- \* Tünel aydınlatmaya uygun

YA-1310 S

Sokak Armatürü

IP 66 - 50-75 Watt



GEN;174 mm UZUN;280 mm

YA-1310 B

Metal Ken.Tapa

Projektörde kullanılır



2,5 mm PASLANMAZ SAC

YA-1310 A

P.C. Enj. Cam+conta (silikon)



CAM ; 270 x 370 mm

YA-1310 U

Metal U Ayak

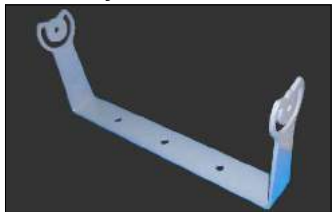

Standart Gen.32 cm

3 mm HRP sac-E.Stk. boya

YA-1310 C

Ken.Tapa Contası

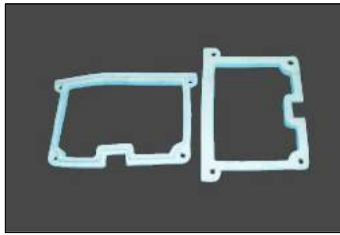

Elastron Conta - Naturel

YA-1310 M

Metal Direk Mafsalı

İkili takım - Renk A.Gri



3 mm HRP sac-E.Stk. boya

YA-1310 Y2

Yatay İkili Projektör



EN:174 mm-BOY:560 mm  
PC Cam YA-1310 A  
YA-1310 Kasaya,YA-1310 A PC.  
İki adet yatay cam uygulaması

YA-1310 T

Metal Ken.Tapa



2,5 mm PASLANMAZ SAC  
Sokak Armatüründe Kullanılır

YA-1310 D2

Dikey İkili Projektör

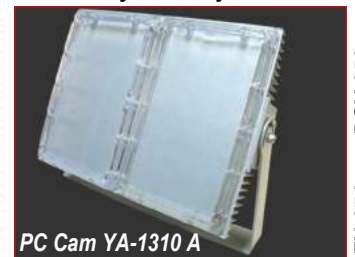

EN:274 mm-BOY:350 mm  
PC Cam YA-1310 A  
YA-1311 Kasaya,YA-1310 A PC.  
İki adet dikey cam uygulaması

İSTENİLEN ÖLÇÜLERDE KESİM YAPILIR

All cutting dimensions can be done according to requirements

ALÜMİNYUM EKSTRÜZYON PROJEKTÖR-SOKAK ARMATÜRÜ  
POLİKARBON DİFÜZÖR

YA-1311

Alm.Led Prj.Kasa  
PC. Enj.Difüzör  
100 watt  
Pcb alanı:240x340 mm

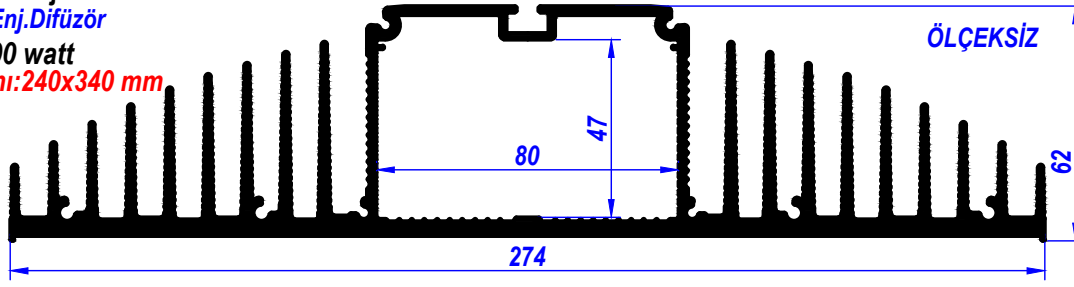

YA-1311 S

Sokak Arm. Kasa  
PC. Enj.Difüzör  
IP 66 - 100 watt

YA-1320 S

Sokak Arm. Kasa  
Takım

YA-1311 P

Projektör Kasası-Takım

Pcb alanı:240x340 mm



EN:274 mm - BOY:380 mm

YA-1311 A

P.C. Enj. Difüzör+conta

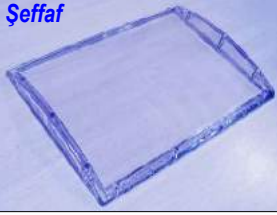

CAM ; 270 x 370 mm

YA-1311 U

Metal U Ayak



3 mm HRP sac-E.Stk. boya

Standart Gen.32 cm

YA-1311 C

Ken.Tapa Contası

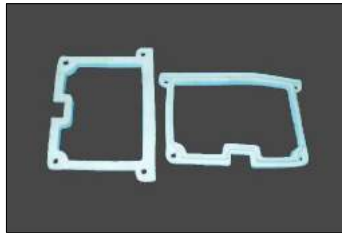

Elastron Conta - Naturel

YA-1311 M

Metal Direk Mafsalı



3 mm HRP sac-E.Stk. boya

İkili takım-Renk A.Gri

YA-1320 Y2

Yatay İkili Projektör



EN:274 mm-BOY:780 mm

PC CAM 1311 P

YA-1311 Kasaya, YA-1311 P PC.  
İki adet yatay cam uygulaması

YA-1311 T

Metal Ken.Tapa



3 mm HRP sac-E.statik boya  
Sokak Armatüründe Kullanılır

YA-1311 D2

Dikey İkili Projektör

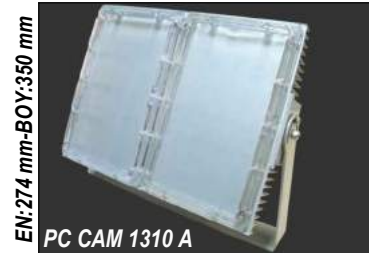

EN:274 mm-BOY:350 mm

PC CAM 1310 A

YA-1311 Kasaya, YA-1310 A PC.  
İki adet dikey cam uygulaması

- \* IP 66 korumalı, ekonomik PROJEKTÖR ve SOKAK armatürü
- \* Benzerlerinden daha fazla soğutma kapasitesine sahip,
- \* Minimum ve kolay işçilik
- \* Geniş driver alanı; 47 x 80 mm
- \* Pcb alanı ; 240 x 340 mm
- \* Kenar tapada sızdırmaz IP 66, birer ad somun perçin kullanılmıştır.
- \* 2 veya 3 sıra cam uygulama imkanı, YA-1311 2 100 + 100 = 200 watt
- \* Ürünlerle birlikte, U ayak, veya direk Mafsalı, Ken. tapa, conta, inox vidalar, IP 68 PG 9 metal rakor gönderilir.
- \* IP 66 Su sızdırmaz, Polycarbon difüzör
- \* Tünel aydınlatmaya uygun
- \* Ürünlerin yeni enjeksiyon Kenar tapa
- \* Alüminyum Profil uzunluğu, 400 cm dir

YA-1320 S

Sokak Armatürü



EN:274 mm - BOY:380 mm

Pcb alanı:240x340 mm

YA-1311 B

Metal Ken.Tapa



2,5 mm PASLANMAZ SAC

Projektörde kullanılır

ALÜMİNYUM EKSTRÜZYON PROJEKTÖR-SOKAK ARMATÜRÜ  
POLİKARBON DİFÜZÖR

**YENİ**  
**YA-1320 P**  
Alm.Led Prj.Kasa  
PC. Enj.Difüzör  
75-100 Watt  
Pcb alanı:140x235 mm

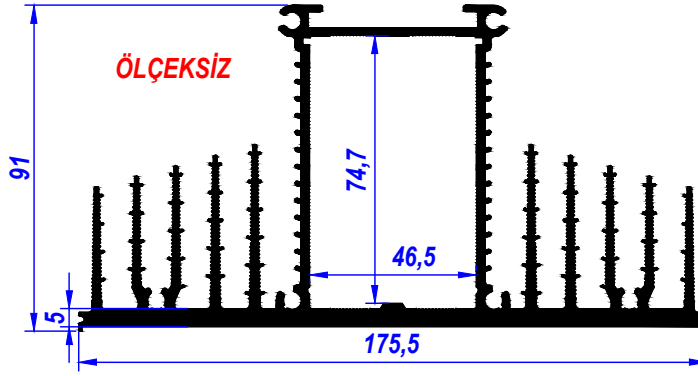

**YENİ**  
**YA-1320 P**  
Projektör Kasası  
Takım  
IP 66, 75-100 Watt  
**YA-1320 S**  
Sokak Arm. Kasa  
Takım  
Pcb alanı:140x235 mm

**YA-1320 P**  
Projektör Kasası-Takım

IP 66 - 75-100 Watt



EN:175,5 mm - BOY:280 mm

- \* IP 66 korumalı yeni ve ekonomik, **PROJEKTÖR** ve **SOKAK** armatürü
- \* **Minimum ağırlık, kolay işçilik**
- \* Benzerlerinden daha yüksek, soğutma kapasitesine sahip,
- \* **Geniş driver alanı ; 46,5 x 74,7 mm**
- \* Pcb alanı ; 140 x 235 mm
- \* **Sokak lambası mafsalı ve U ayak, HRP sac 3 mm, açık gri, elektro statik toz boyalıdır**
- \* **Faturalı, elastron, sızdırmaz kenar tapa contası**
- \* **Yeni güçlendirilmiş, IP 66 korumalı, sızdırmaz Pls.Kenar Tapa**
- \* **Yan yana 2 veya 3 sıra PC. uygulama**
- \* **Tünel aydınlatmaya uygun**
- \* **Sokak armatürün yeni direk mafsalı yakında satışa sunulacaktır.**
- \* **Tünel aydınlatmaya uygun**
- \* **Ürünlerle birlikte, U ayak, veya direk Mafsalı,Ken. tapa,conta,inox vidalar, IP 68 PG 7 metal rakor gönderilir.**
- \* **Alüminyum Profil uzunluğu, 400 cm dir**

**YA-1320 S**  
Sokak Armatürü

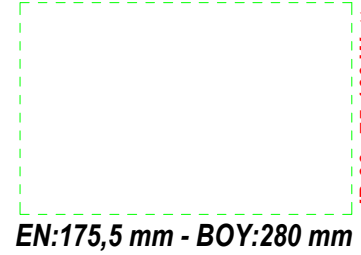

IP 66 - 75-100 Watt

EN:175,5 mm - BOY:280 mm

**YA-1310 A**

P.C. Enj. Difüzör+conta

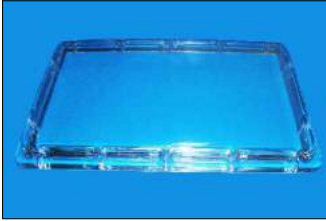

PC.CAM ; 170 x 270 mm

**YA-1320 U**

Metal U Ayak

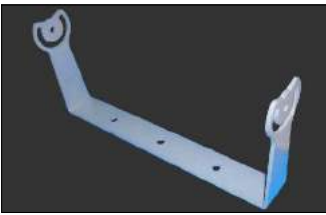

3 mm HRP sac-E.Stk. boya

Standart Gen.32 cm

**YA-1320 C**

Ken.Tapa Contası



Takım, Arka görünüş

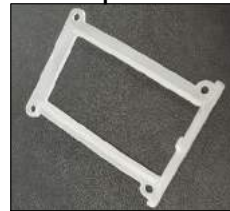

Elastron Conta-Naturel

**YA-1320 T**

Pls.Kenar Tapa



Güçlendirilmiş Plastik-Açık Gri

**YA-1320 M**

Metal Direk Mafsalı



İkili takım-Renk A.Gri  
3 mm HRP sac-E.Stk. boya

**YA-1320 Y2**

Yatay İkili Projektör

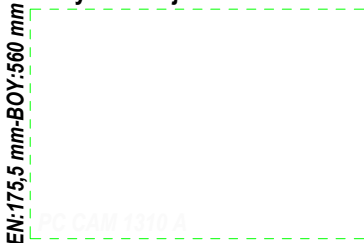

EN:175,5 mm-BOY:560 mm  
YA-1320 Kasaya, YA-1311 P PC.  
İki adet yatay cam uygulaması

**SOĞUTMA KAPASİTESİ YÜKSEK**  
**YA-1320 PROJEKTÖR - SOKAK ARM. KASASI**

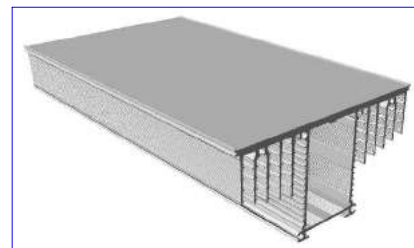

İSTENİLEN ÖLÇÜLERDE KESİM YAPILIR

**YA-1320 D2**

Dikey İkili Projektör

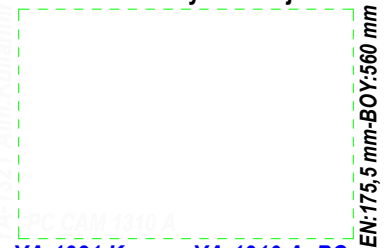

EN:175,5 mm-BOY:560 mm  
YA-1321 Kasaya, YA-1310 A PC.  
İki adet dikey cam uygulaması

ALÜMİNYUM EKSTRÜZYON PROJEKTÖR-SOKAK ARMATÜRÜ  
POLİKARBON DİFÜZÖR

**YENİ**  
**YA-1321**  
Alm.Led Prj.Kasa  
PC. Enj.Difüzör  
100-150 Watt  
Pcb alanı;240x340 mm

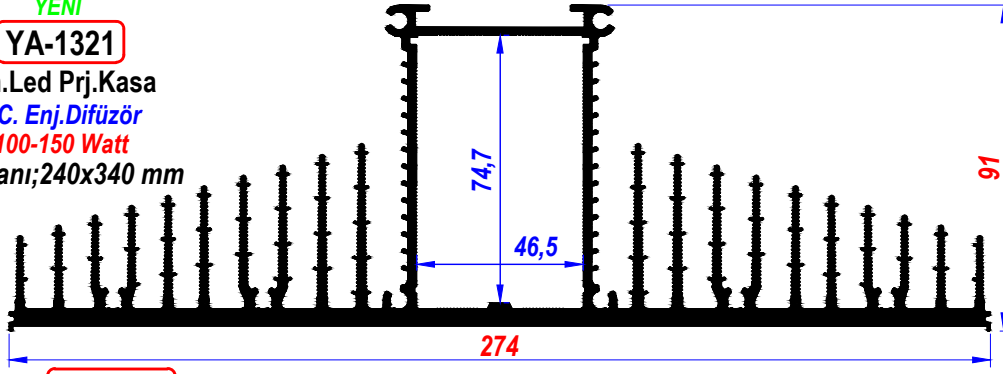

**YENİ**  
**YA-1321 P**  
Projektör Kasası  
Takım  
IP 66 100-150 Watt  
**YA-1321 S**  
Sokak Arm. Kasa  
Takım  
Pcb alanı;240x340 mm

**YA-1321 P**  
Projektör Kasası-Takım



EN:274 mm - BOY:380 mm  
IP 66 - 100-150 Watt

**YA-1311 A**

P.C. Enj. Difüzör+conta

Standart Gen.32 cm

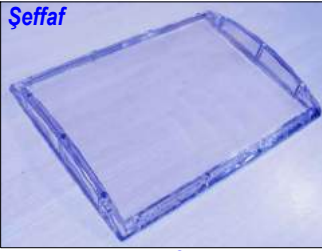

PC.;270x370 mm

**YA-1321 U** Metal U Ayak



3 mm HRP sac-E.Stk. boya

Standart Gen.32 cm

**YA-1321 P**



Takım, Arka görünüş

**YA-1320 C**

Ken.Tapa Contası



Elastron Conta-Naturel

**YA-1320 T**

Pls.Kenar Tapa



Güçlendirilmiş Plastik-Açık Gri

**YA-1321 M**

Metal Direk Mafsalı



İkili takım-Renk A.Gri  
3 mm HRP sac-E.Stk. boya

**YA-1321 D2**

Dikey İkili Projektör

**YA-1320 Y2**

Yatay İkili Projektör



EN:175,5 mm-BOY:560 mm

YA-1320 Kasaya, YA-1311 P PC.  
İki adet yatay cam uygulaması

SOĞUTMA KAPASİTESİ YÜKSEK, yeni  
YA-1321 PROJEKTÖR-SOKAK ARM. KASASI

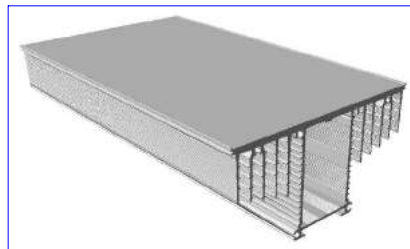

İSTENİLEN ÖLÇÜLERDE KESİM YAPILIR

PC.Cam,yan yana dikey çoklu  
uygulanabilir

EN:175,5 mm-BOY:560 mm

**YENİ, ALÜMİNYUM EKSTRÜZYON PROJEKTÖR- KÜÇÜK**

**YENİ**

**YA-1300 Y**

Alm.Led Prj.Kasa  
Küçük  
50-75 Watt  
Pcb genişliği :127 mm

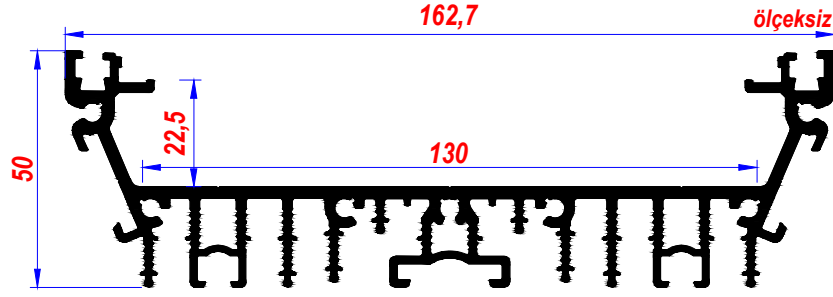

**KOLAY İŞÇİLİKLE, IP 66 YAPILABİLECEK, YENİ ÜRÜN**

**YA-266 Ç**

Alm. Cam Çıta Prf.

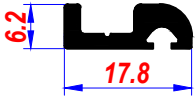

**Fitil,cam çıta profiline takılır**

**YA-266 F**

Silikon Cam Fitili



**YA-1300 T YENİ**

Pls.Kenar Tapa



**RENK: Açık gri**

**Güçlendirilmiş Plastik Tapa**

**YA-1300 C YENİ**

Ken.Tapa Contası



**Silikon Conta-Naturel, Bordo**

**YA-1388**

Alm. Driver Prf.

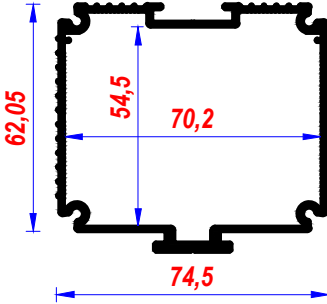

**YA-1388 A**

Driver Prf. Ken.Tapa

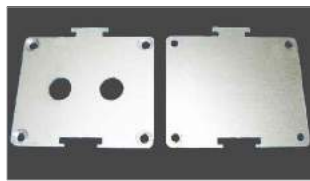

**ALM. KENAR TAPA**

**YA-1388 C**

Driver Ken.Tapa Contası

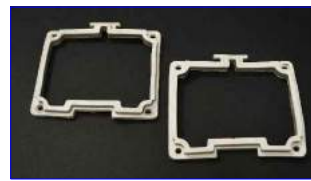

**Elastron Conta - A.Gri**

**YA-1300 U**

Metal U Ayak

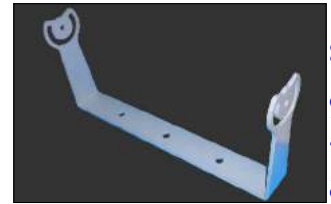

**Standart Gen.32 cm**

**Üç noktadan, tavana sarkıt olarak asabilme imkanı**

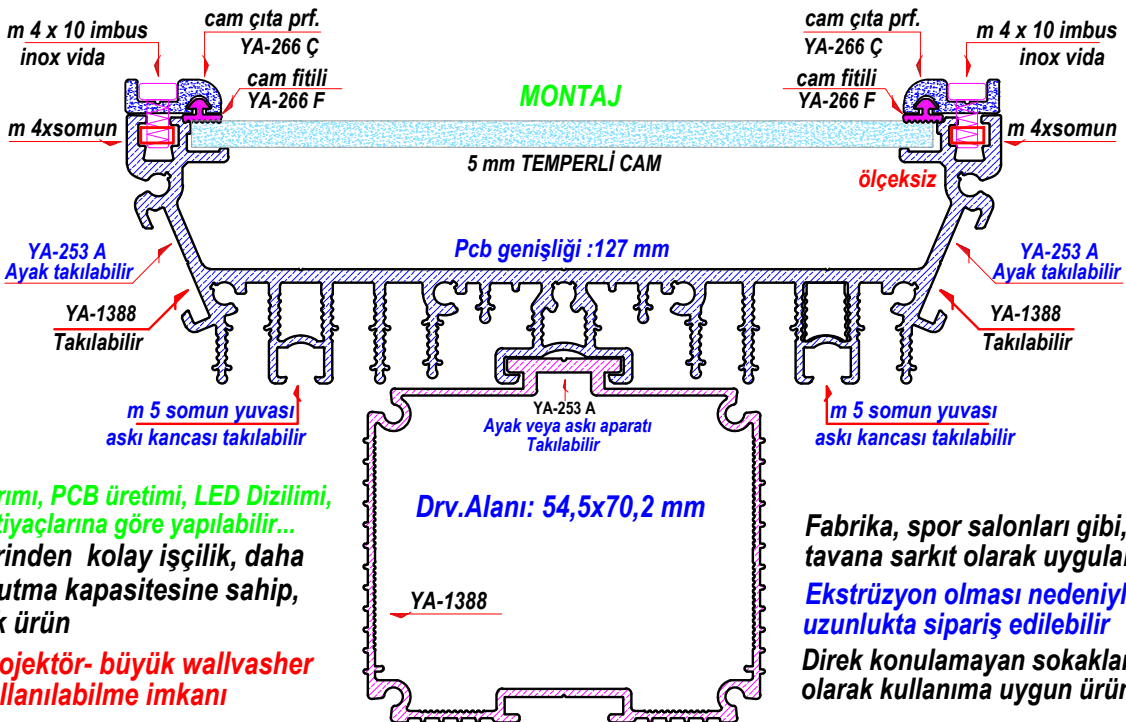

**PCB Tasarımı, PCB üretimi, LED Dizilimi, Müşteri ihtiyaçlarına göre yapılabilir...**

**Benzerlerinden kolay işçilik, daha fazla soğutma kapasitesine sahip, ekonomik ürün**

**Küçük projektör- büyük wallwasher olarak kullanılabilme imkanı**

**Fabrika, spor salonları gibi, yerlerde tavana sarkıt olarak uygulanır**

**Ekstrüzyon olması nedeniyle istenilen uzunlukta sipariş edilebilir**

**Direk konulamayan sokaklarda, sarkıt olarak kullanıma uygun ürün...**

ALÜMİNYUM EKSTRÜZYON PROJEKTÖR  
KÜÇÜK

YA-1300

Alm.Led Prj.Kasa  
Küçük  
50 Watt  
Pcb genişliği :127 mm

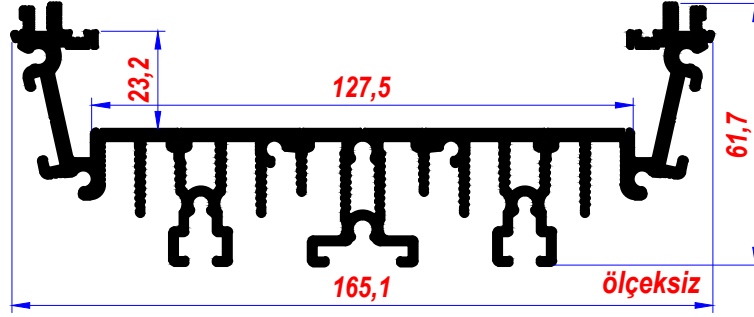

YA-1300 U

Metal U Ayak

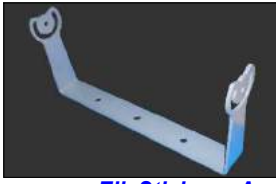

3 mm sac-Elk.Stk.boya-A.gri

YA-302 E

Küçük L Ayak

YA-1300 B

Metal Kenar Tapa A.Gri



5 mm HRP sac-statik boya

YA-1300 C

Elastron Conta

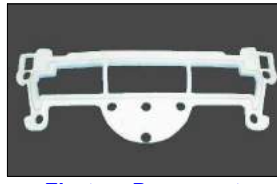

Elastron Beyaz conta

YA-1300 A

Alm.Cam Çıta Prf.

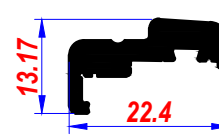

YA-1300 F

U Cam Fitili



Silikon-Şeffaf

Standart Gen.32 cm

YA-1388 A

Alm. Kenar Tapa

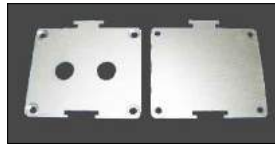

YA-1388 C

Kenar Tapa contası



Elastron Conta - Naturel

YA-1388

Alm. Driver Prf.

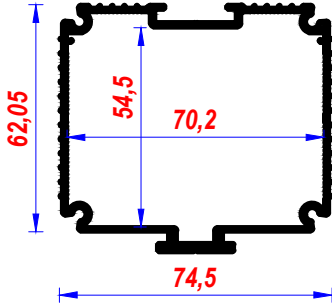

YA - 1300



PCB Genişliği ; 127 mm

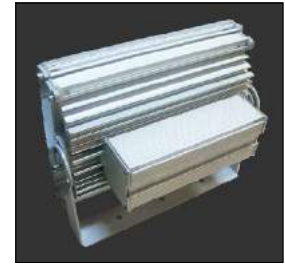

30 cm uzunlukta; 50 watt

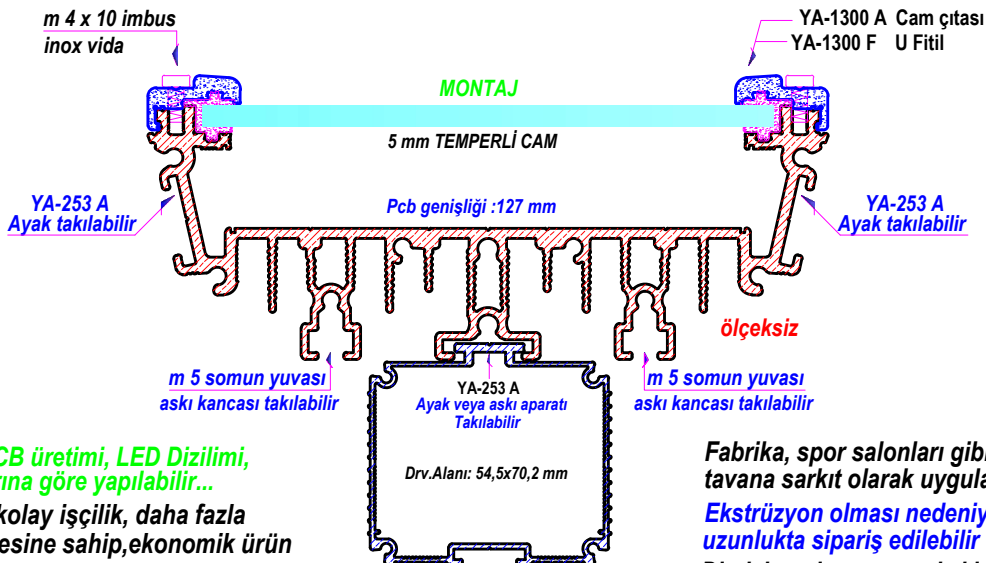

PCB Tasarımı, PCB üretimi, LED Dizilimi,  
Müşteri ihtiyaçlarına göre yapılabilir...

Benzerlerinden kolay işçilik, daha fazla  
soğutma kapasitesine sahip,ekonomik ürün  
Küçük projektör- büyük wallvasher  
olarak kullanılabilme imkanı

Fabrika, spor salonları gibi, yerlerde  
tavana sarkıt olarak uygulanır  
Ekstrüzyon olması nedeniyle istenilen  
uzunlukta sipariş edilebilir  
Direk konulamayan sokaklarda, sarkıt  
olarak kullanıma uygun ürün...

ALÜMİNYUM EKSTRÜZYON PROJEKTÖR  
ORTA

YA-1301

Alm.Led Prj.Kasa  
Orta  
75 Waat  
Pcb genişliđi:175 mm

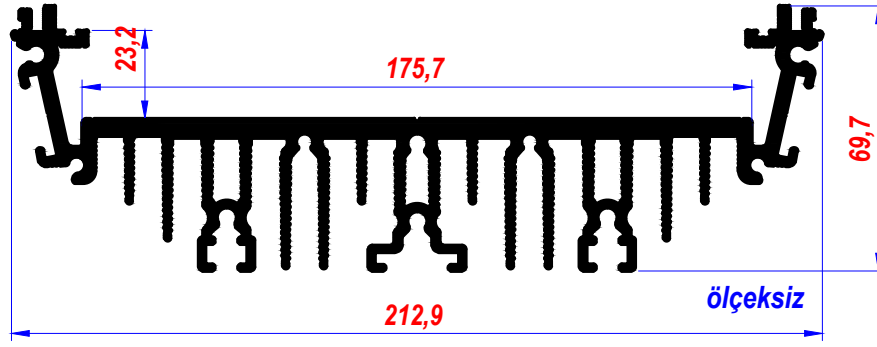

YA-1301 B

Metal Kenar Tapa

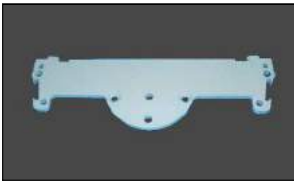

5 mm HRP sac-statik boyu

YA-1301 C

Elastron Conta

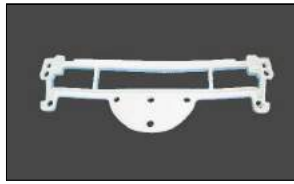

Elastron Beyaz conta

YA-1301 U

Metal U Ayak



Standart genişlik 32 cm  
Farklı ölçülerde üretilebilir

YA-1300 A

Alm.Cam Çıta Prf.

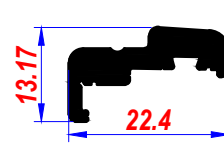

YA-1300 F

U Cam Fiteli

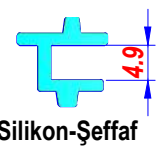

Silikon-Şeffaf

YA-1388 A

Alm. Kenar Tapa

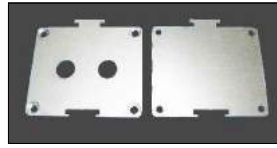

YA-1388 C

Kenar Tapa contası



Elastron Conta - Naturel

YA-1388

Alm. Driver Prf.

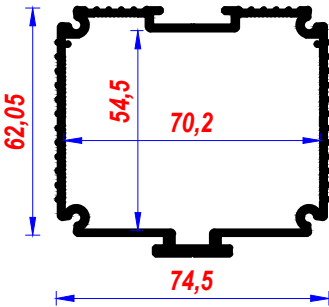

YA - 1301



PCB Genişliđi ; 175 mm



30 cm uzunlukta; 75 watt

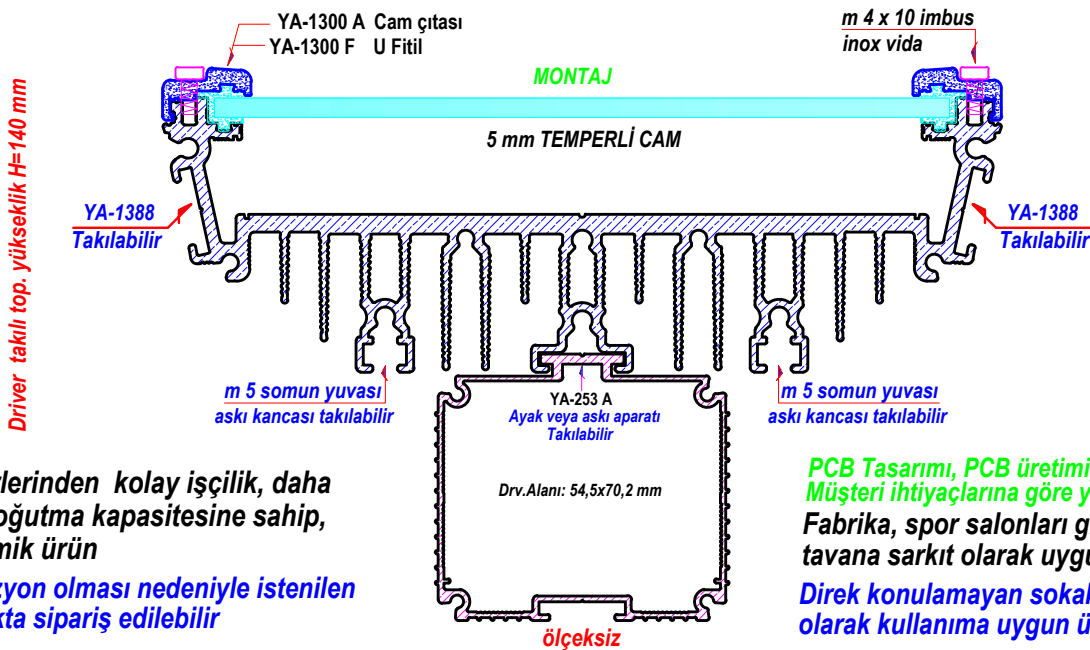

Benzerlerinden kolay işçilik, daha fazla sođutma kapasitesine sahip, ekonomik ürün

Ekstrüzyon olması nedeniyle istenilen uzunlukta sipariş edilebilir

PCB Tasarımı, PCB üretimi, LED Dizilimi, Müşteri ihtiyaçlarına göre yapılabilir...

Fabrika, spor salonları gibi, yerlerde tavana sarkıt olarak uygulanır

Direk konulamayan sokaklarda, sarkıt olarak kullanıma uygun ürün...

ALÜMİNYUM EKSTRÜZYON PROJEKTÖR  
BÜYÜK

YA-1302

Alm.Led Prj.Kasa  
Büyük  
100-150 Waat  
Pcb genişliği:264 mm

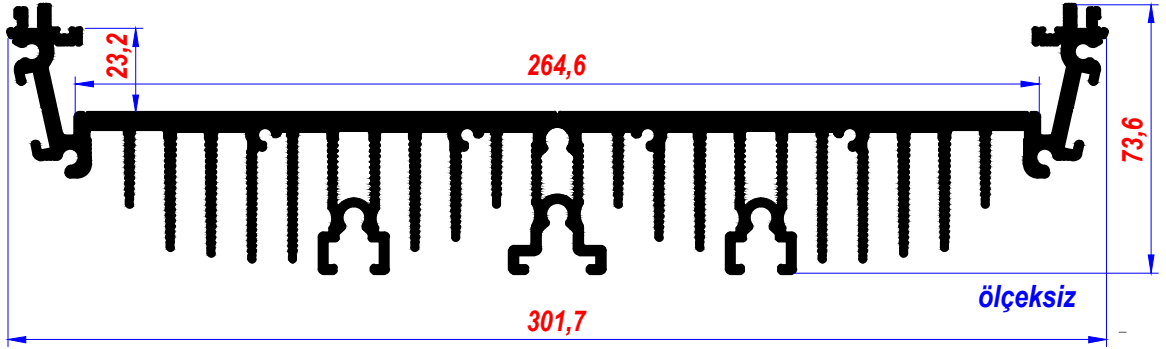

YA-1302 B

Metal Kenar Tapa



5 mm HRP sac-statik boya

YA-1302 C

Elastron Conta

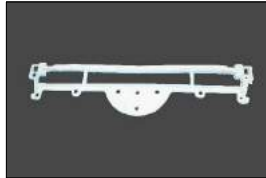

Elastron Beyaz conta

YA-1302 U

Metal U Ayak



standart genişlik 32 cm  
Farklı ölçülerde üretilebilir

YA-1300 A

Alm.Cam Çıta Prf.

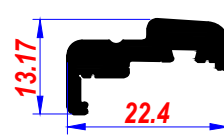

YA-1300 F

U Cam Fitili



Silikon-Şeffaf

YA-1388

Alm. Driver Prf.

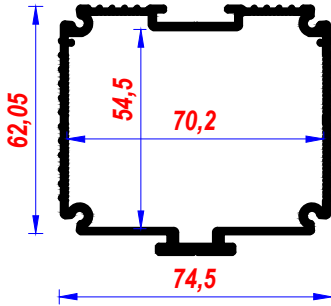

YA-1388 A

Alm. Kenar Tapa

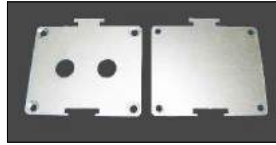

YA-1388 C

Kenar Tapa contası



Elastron Conta - Naturel

YA-1302



PCB Genişliği ; 264 mm

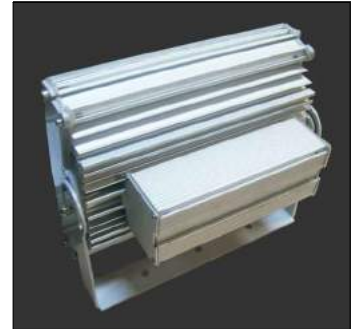

30 cm uzunlukta; 100 watt

Driver takılı top. yükseklik H=144 mm

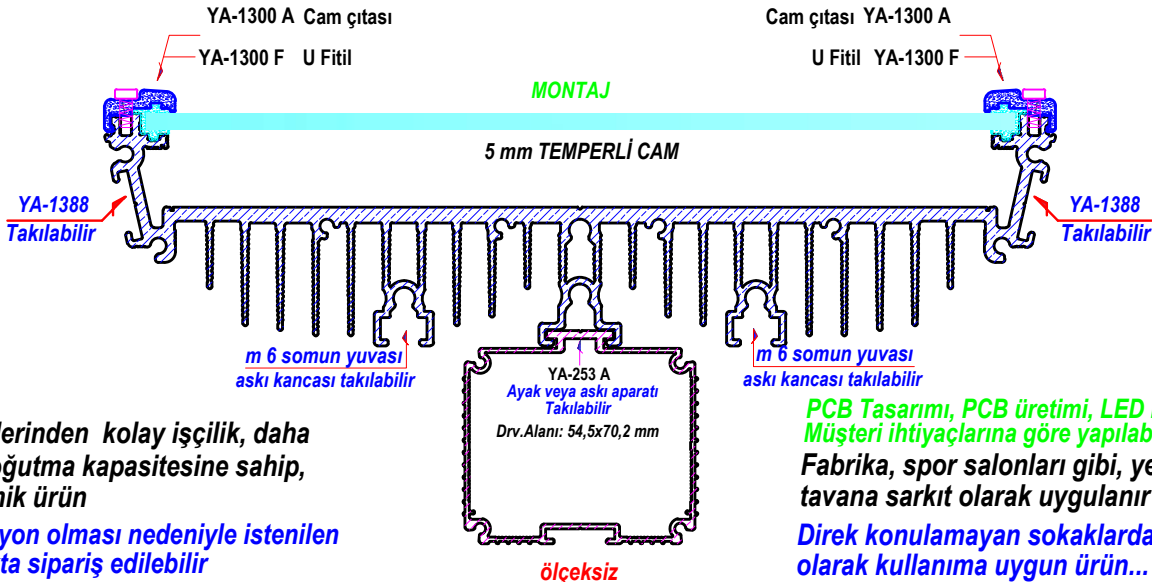

Benzerlerinden kolay işçilik, daha fazla soğutma kapasitesine sahip, ekonomik ürün

Ekstrüzyon olması nedeniyle istenilen uzunlukta sipariş edilebilir

PCB Tasarımı, PCB üretimi, LED Dizilimi, Müşteri ihtiyaçlarına göre yapılabilir...

Fabrika, spor salonları gibi, yerlerde tavana sarkıt olarak uygulanır

Direk konulamayan sokaklarda, sarkıt olarak kullanıma uygun ürün...

RK - 004

Alm. Reklam Prf.  
Kayan Yazı

Mat siyah statik boya

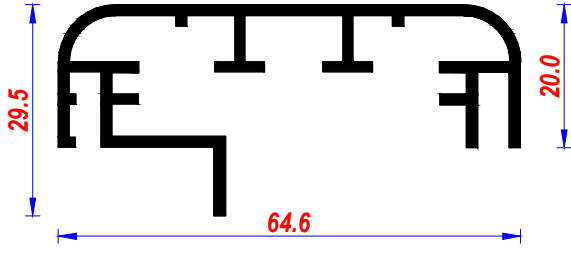

RK - 004

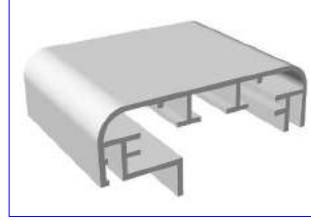

ALM.PR.F. 600 cm

RK-004 A

Plastik Köşe BirleŐtirme



Renk siyah

Alm. Reklam-Tabela Prf

RK - 005

ÖLÇEK: 3/4

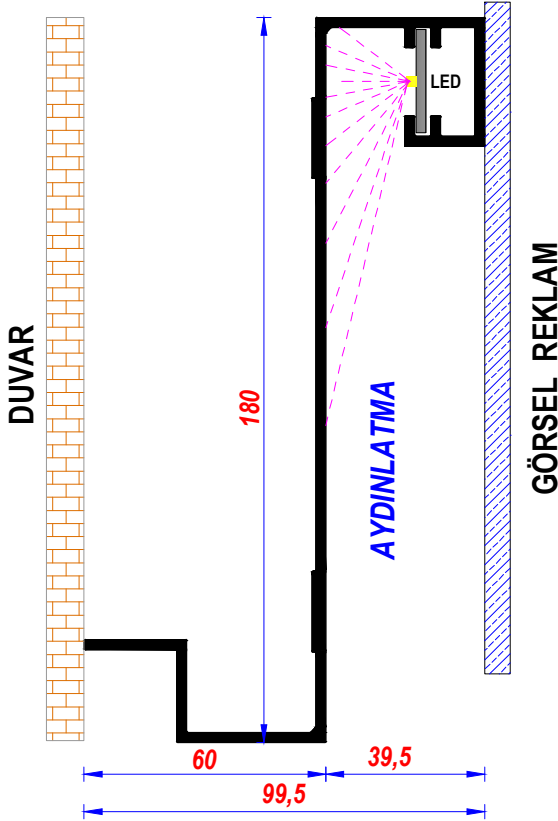

RK - 005

ALM.PR.F. 600 cm

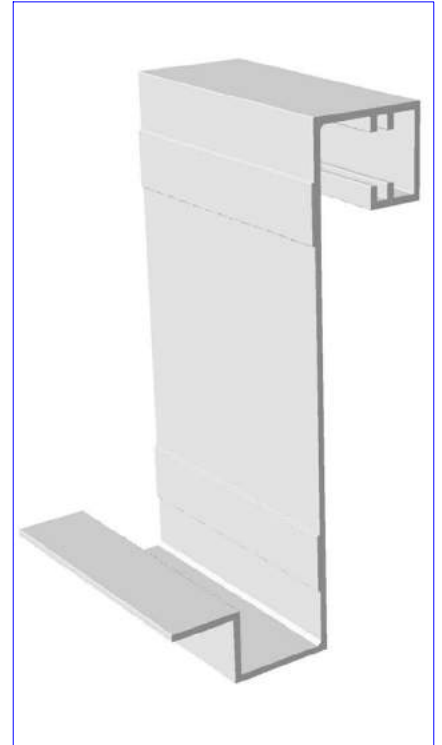

RK - 001A

P.C. Difüzör

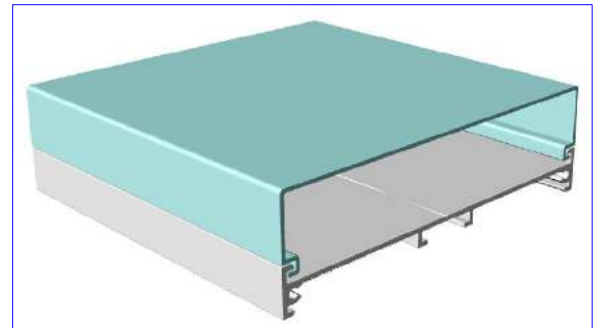
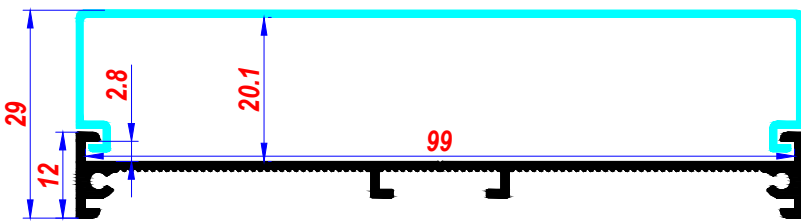

RK - 001

Alm. Reklam Yönlendirme / Led Prf.

RK-001 T

Alm. Kenar Tapa

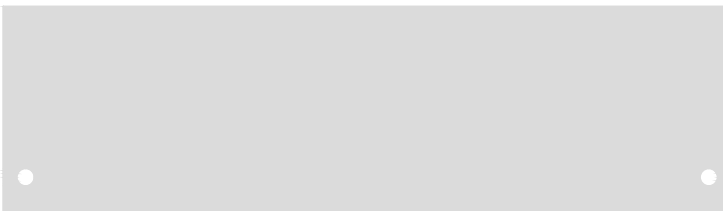

İSTENİLEN ÖLÇÜLERDE KESİM YAPILIR

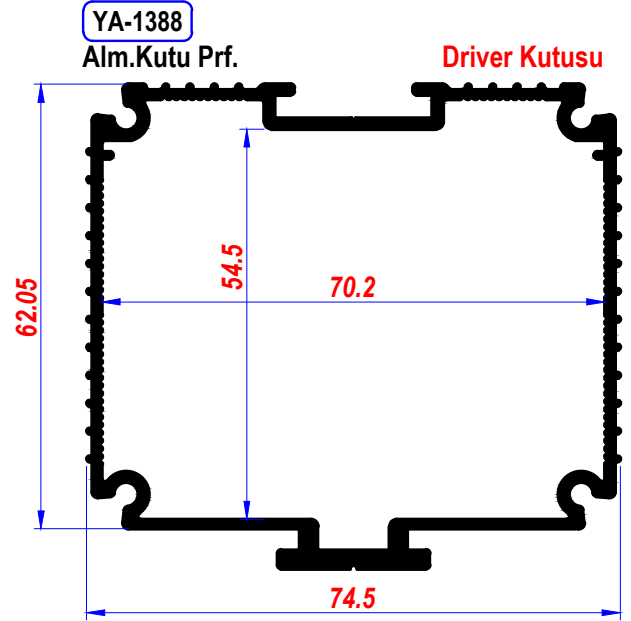
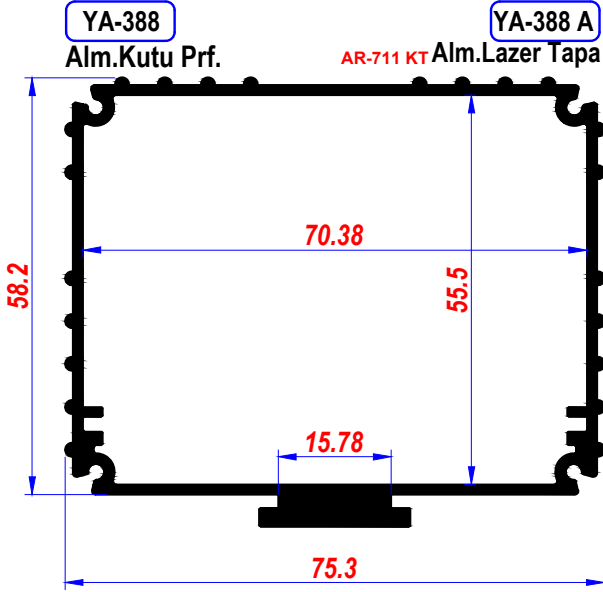
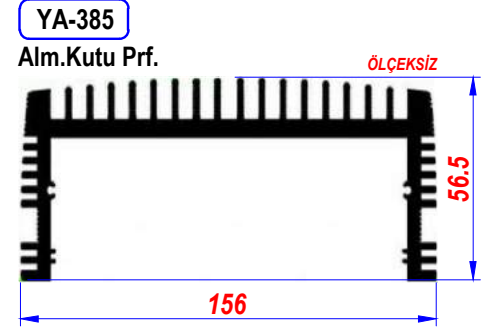
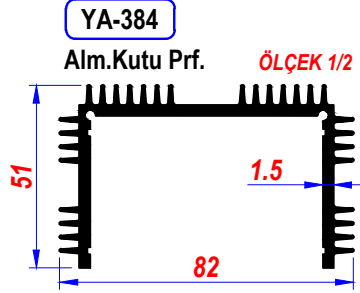
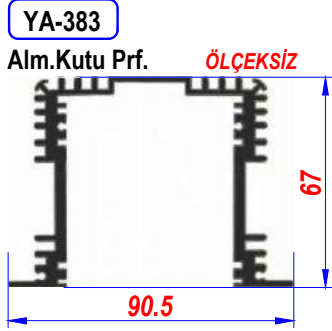
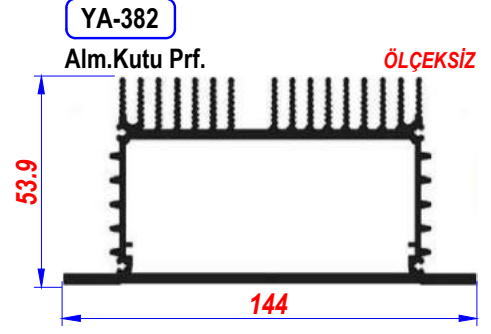
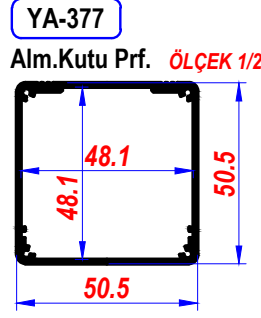
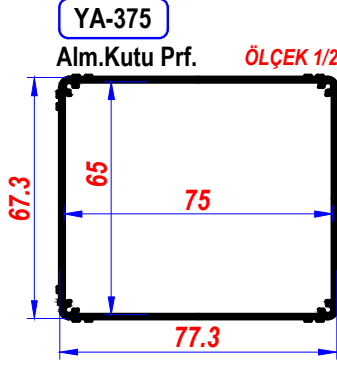

YA-1388 A  
Alm. Kenar Tapa

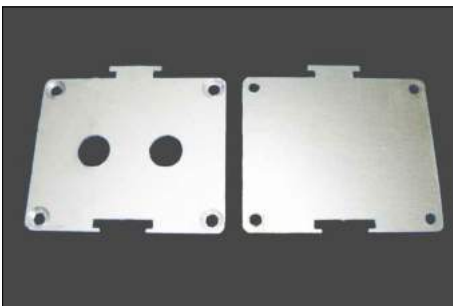

YA-1388 C  
Ken.Tapa Contası



Elastron Conta - Naturel

İSTENİLEN ÖLÇÜLERDE KESİM YAPILIR

**SİGMA PROFİL Aksesuarları için bilgi alınız**

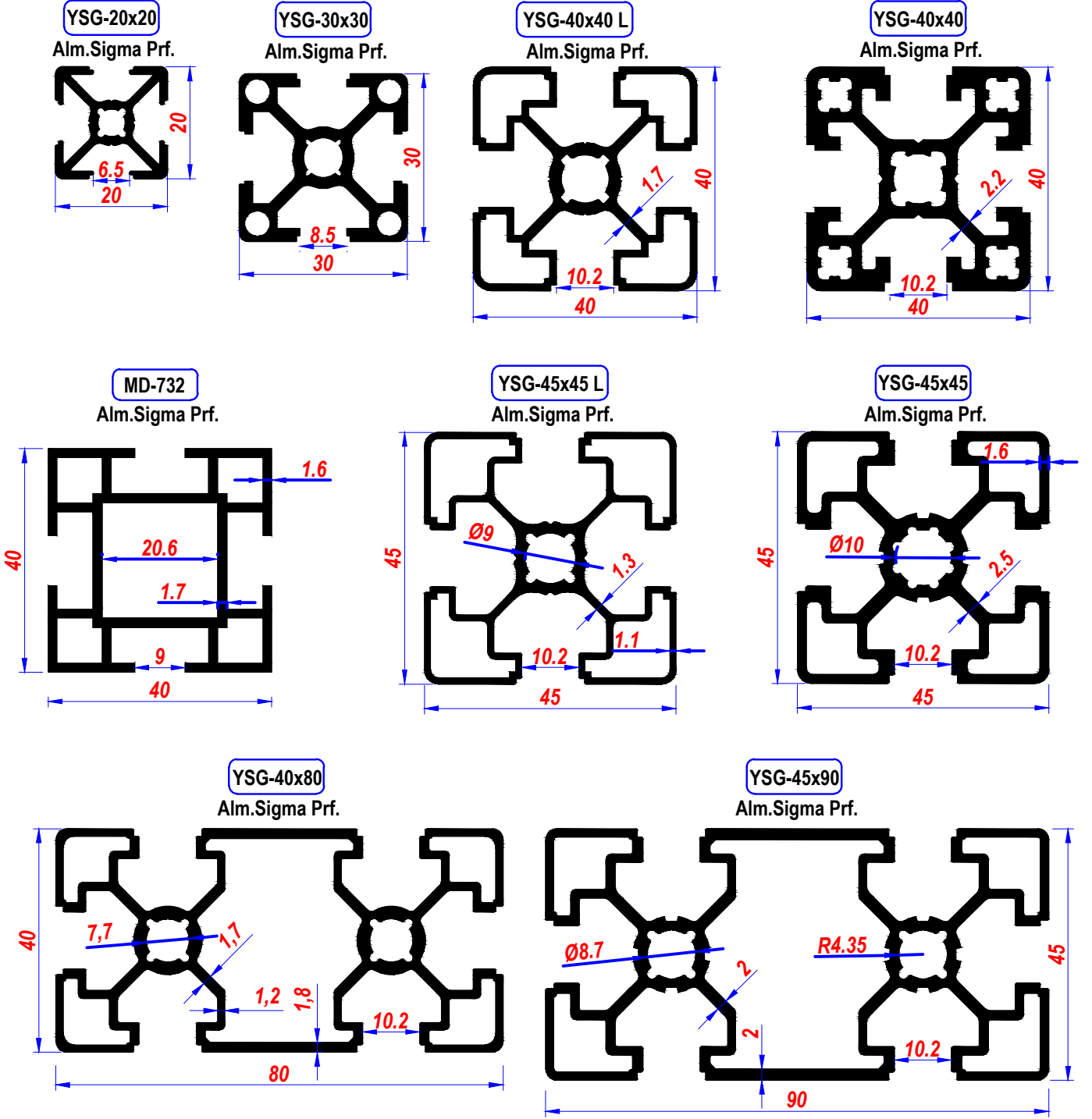

**Katalogda olmayan modeller için bilgi alınız**

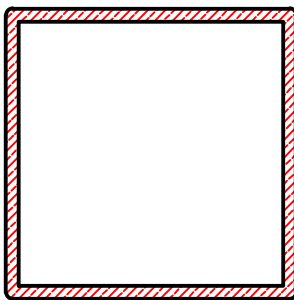

**KUTU / BORU Profilleri  
Ölçüler için bilgi alınız**

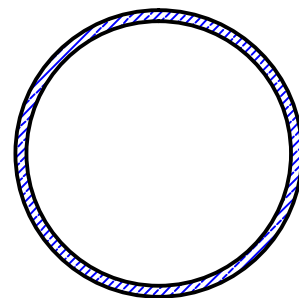

İSTENİLEN ÖLÇÜLERDE KESİM YAPILIR

AYDS-75

75 mm Alm. Prf.  
ÖLÇEK 1/1

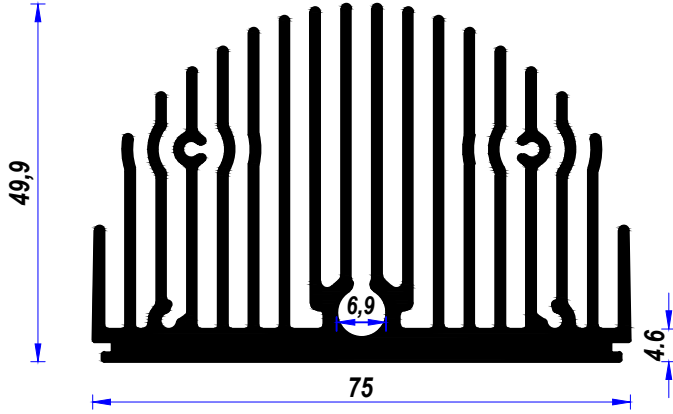

MODÜL LENS UYGULAMASI



METAL TAPA + AYAK

YENİ

AYDS-93

93 mm Alm. Prf.  
ÖLÇEK 1/1

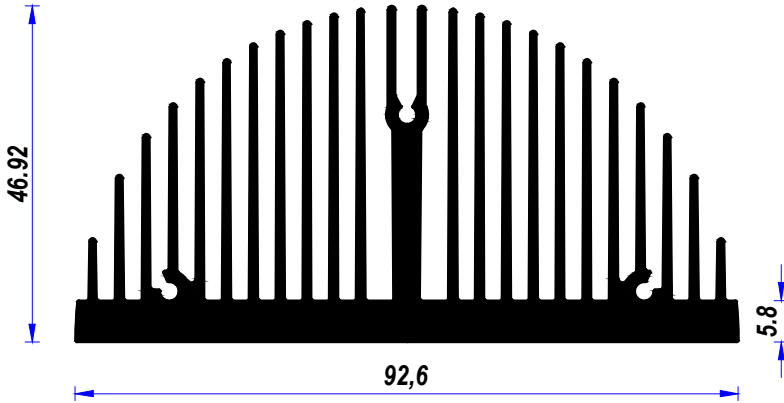

YA-265 P PC DİFÜZÖR



METAL TAPA + AYAK

YENİ

AYDS-96

96 mm Alm. Prf.  
ÖLÇEK 1/1

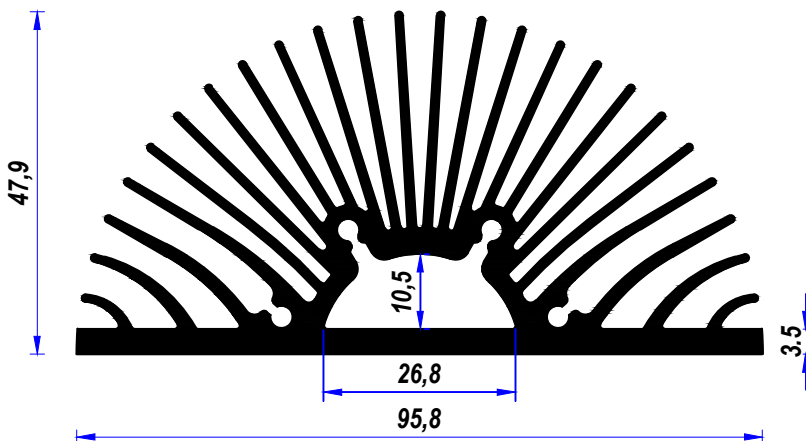

MODÜL LENS UYGULAMASI



METAL TAPA + AYAK

İSTENİLEN ÖLÇÜLERDE KESİM YAPILIR - ALM. FLANŞ YAPILIR - SİYAH ELOKSAL KAPLAMA YAPILIR  
All cutting dimensions can be done according to requirements-Doable black Anodize-Aluminium flange can be supplied

YENİ

AYS - 25

Q 25 mm Alm. Prf.  
ÖLÇEK 1/1

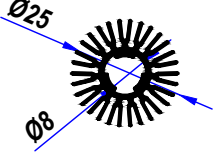

AYS - 30

Q 30 mm Alm. Prf.  
ÖLÇEK 1/1

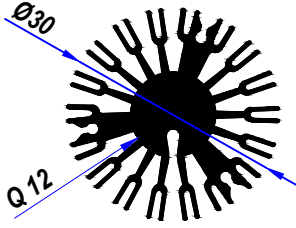

AYS - 35

Q 35,6 mm Alm. Prf.  
ÖLÇEK 1/1

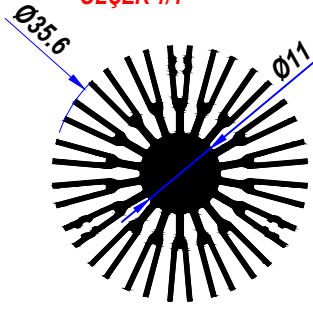

AYS - 47

Q 47 mm Alm. Prf.  
ÖLÇEK 1/1

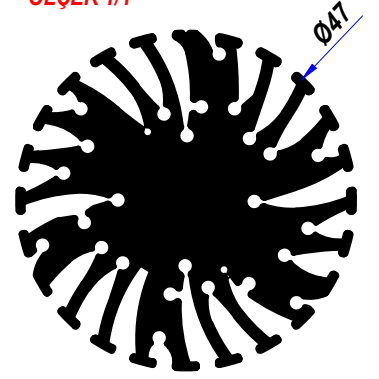

YENİ

AYS - 50

Q 50 mm Alm. Prf.  
ÖLÇEK 1/1

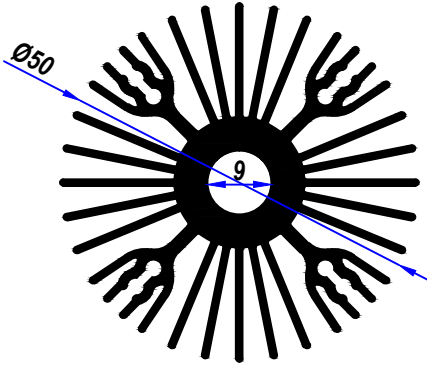

AYS - 52

Q 52,5 mm Alm. Prf.  
ÖLÇEK 1/1

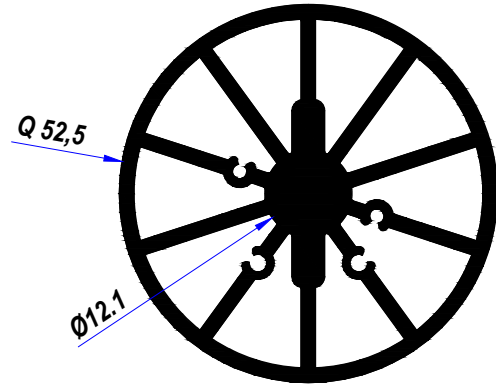

AYS - 60

Q 60 mm Alm. Prf.  
ÖLÇEK 1/1

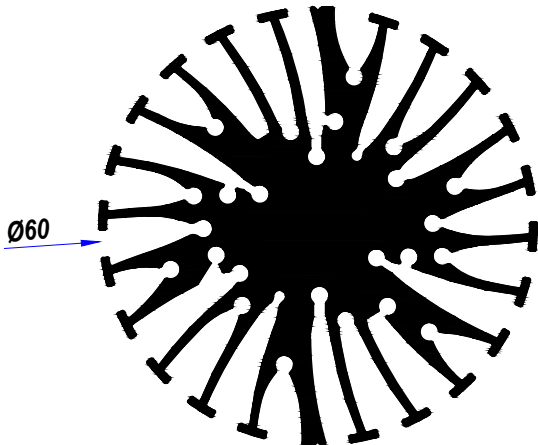

AYS - 61

Q 61 mm Alm. Prf.  
ÖLÇEK 1/1

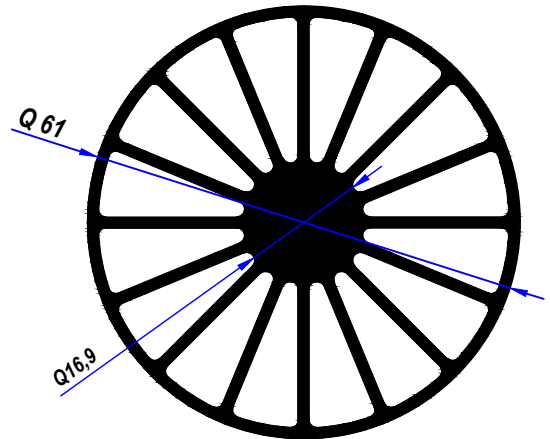

İSTENİLEN ÖLÇÜLERDE KESİM YAPILIR - ALM. FLANŞ YAPILIR - SİYAH ELOKSAL KAPLAMA YAPILIR

All cutting dimensions can be done according to requirements-Doable black Anodize-Aluminium flange can be supplied

AYS - 65

Q 65 mm Alm. Prf.

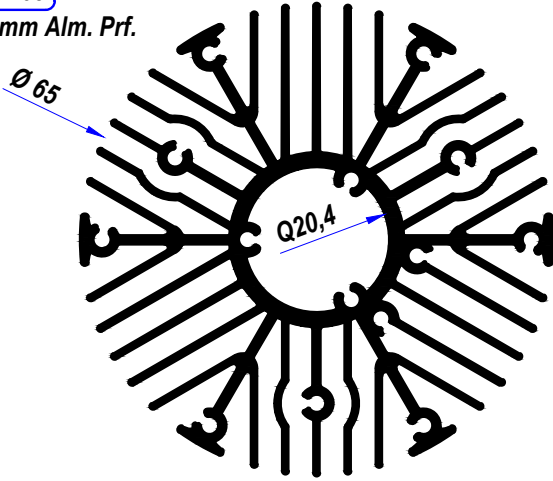

ÖLÇEK 1/1

AYS-65 A YENİ

Q 65 mm Alm. Prf.

AVZ-002 P

PC Difüzör

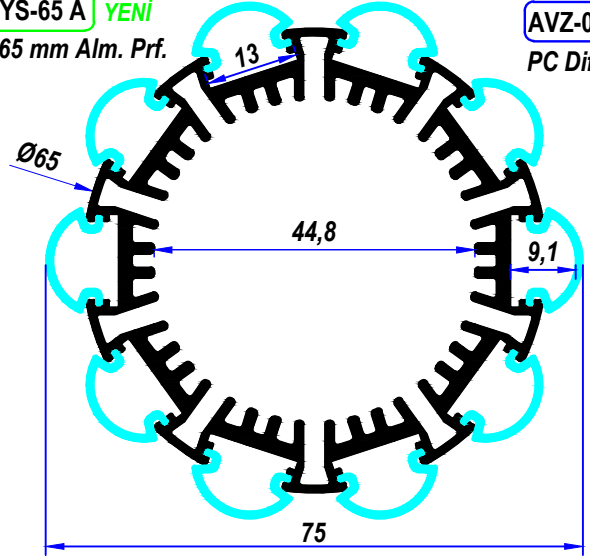

AYS - 70

Q 70 mm Alm. Prf.

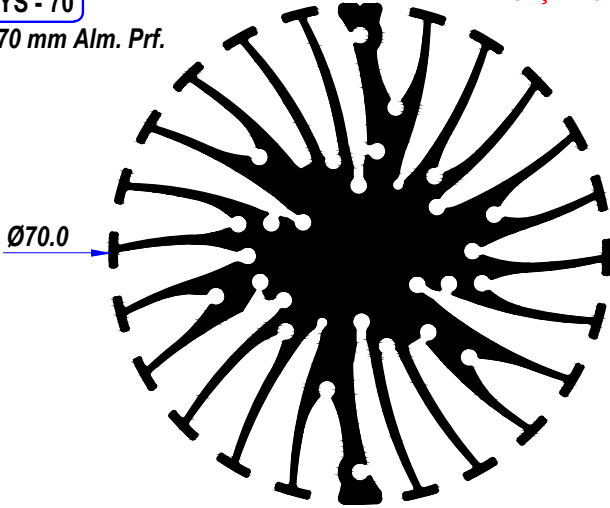

ÖLÇEK 1/1

AYS - 72

Q 72 mm Alm. Prf.

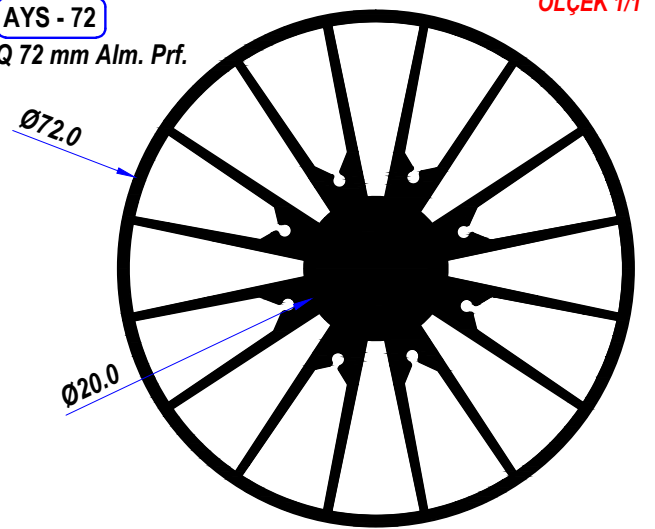

ÖLÇEK 1/1

AYS - 80

Q 80 mm Alu. Prf.

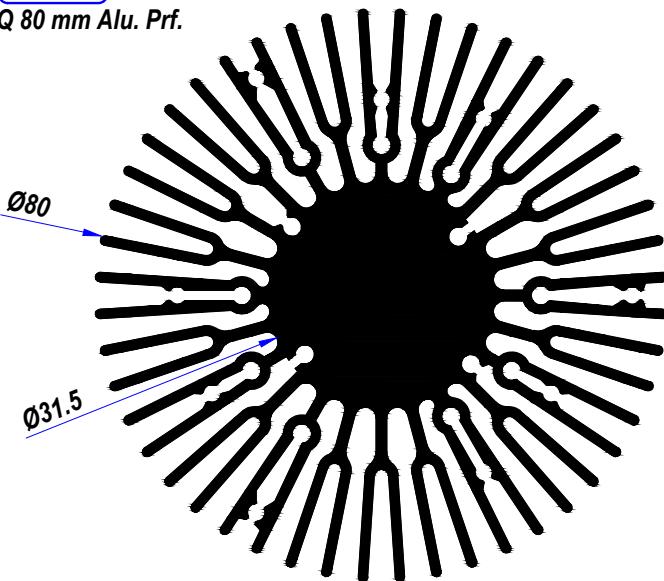

ÖLÇEK 1/1

AYS - 80 A

Q 80,5 mm Alu. Prf.

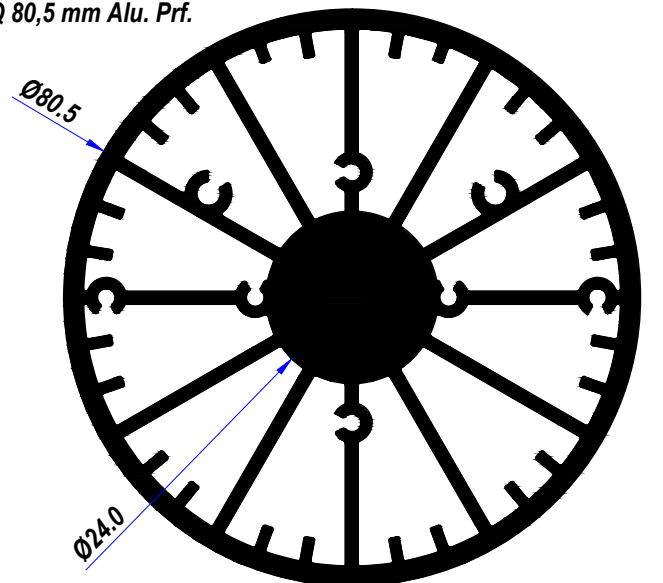

ÖLÇEK 1/1

İSTENİLEN ÖLÇÜLERDE KESİM YAPILIR - ALM. FLANŞ YAPILIR - SİYAH ELOKSAL KAPLAMA YAPILIR  
All cutting dimensions can be done according to requirements-Doable black Anodize-Aluminium flange can be supplied

AYS - 86

Q 86 mm Alm. Prf.

ÖLÇEK 3/4

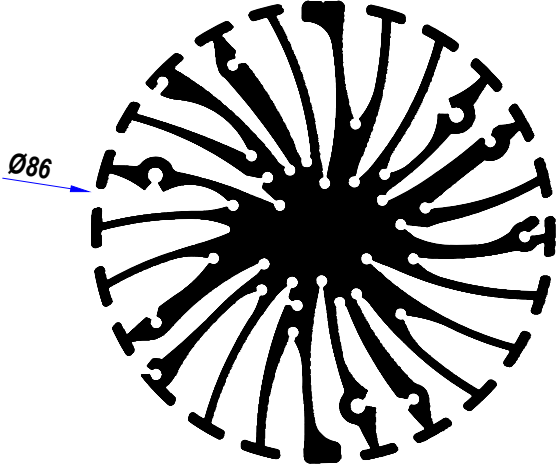

AYS - 89

Q 89 mm Alm. Prf.

ÖLÇEK 3/4

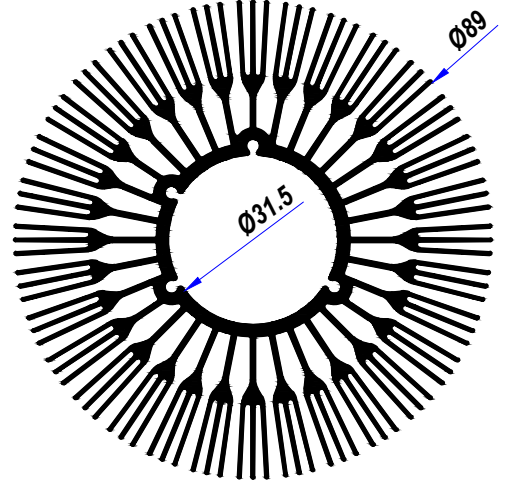

AYS - 90

Q 90 mm Alm. Prf.

ÖLÇEK 3/4

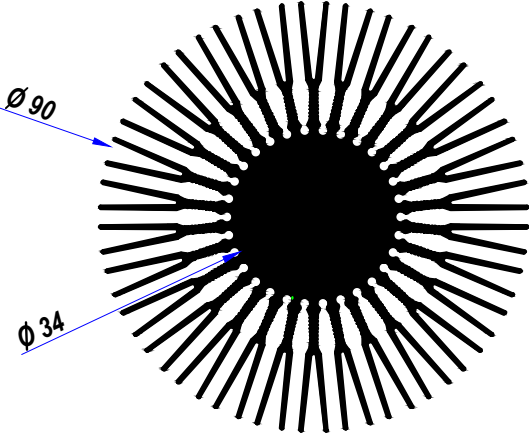

AYS - 92

Q 92 mm Alm. Prf.

ÖLÇEK 3/4

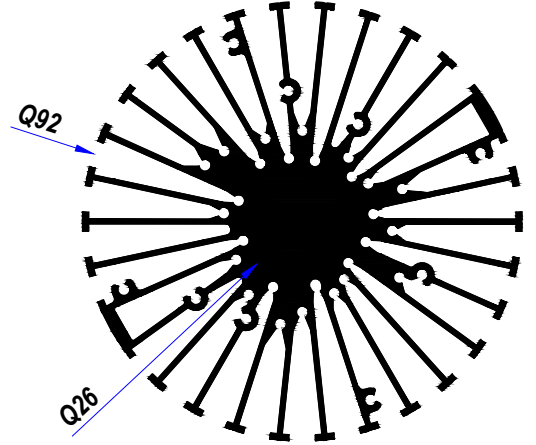

AYS - 95

Q 95 mm Alm. Prf.

ÖLÇEK 3/4

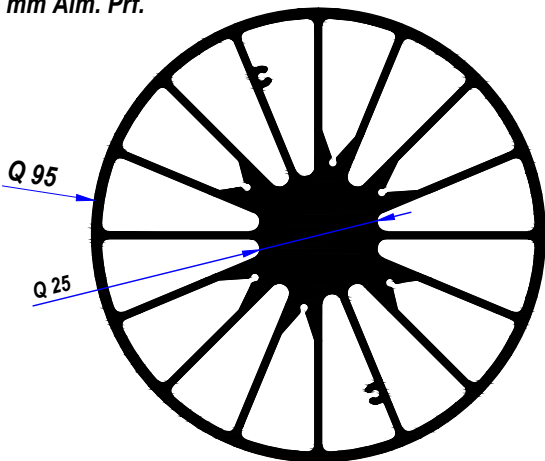

AYS - 99

Q 99 mm Alm. Prf.

ÖLÇEK 3/4

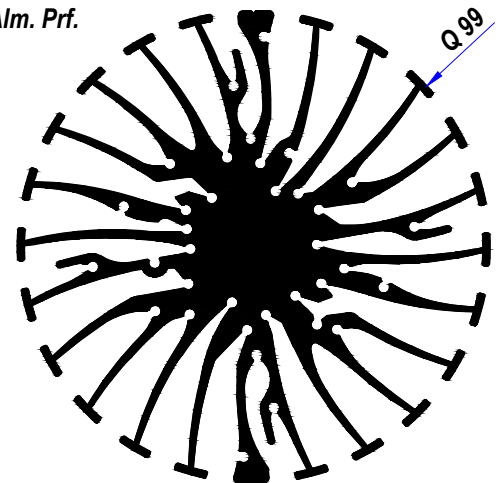

İSTENİLEN ÖLÇÜLERDE KESİM YAPILIR - ALM. FLANŞ YAPILIR - SİYAH ELOKSAL KAPLAMA YAPILIR

All cutting dimensions can be done according to requirements-Doable black Anodize-Aluminium flange can be supplied

AYS - 99 A

Q 99 mm Alm. Prf.

ÖLÇEK 3/4

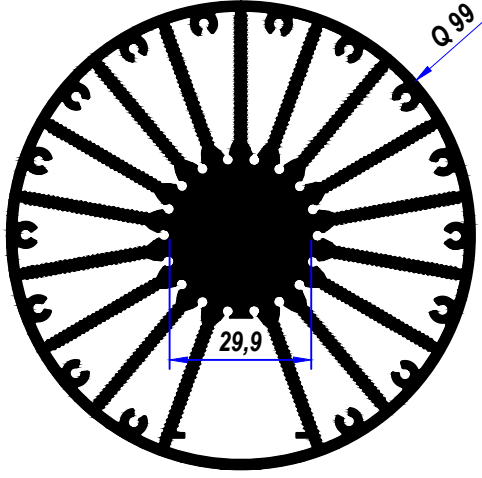

AYS - 100

Q 100,5 mm Alm. Prf.

ÖLÇEK 3/4

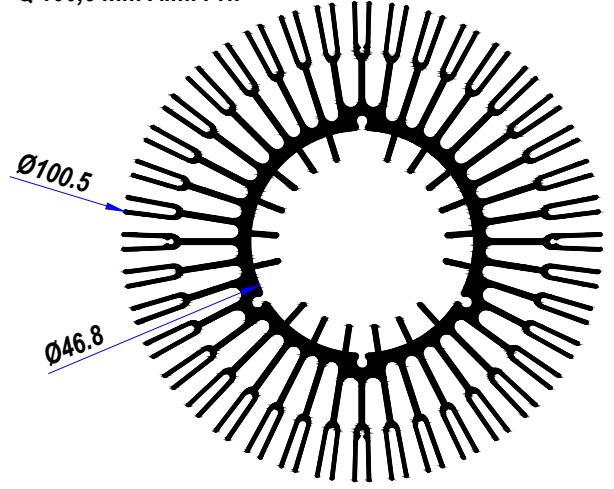

AYS - 105

Q 105 mm Alm. Prf.

ÖLÇEK 1/2

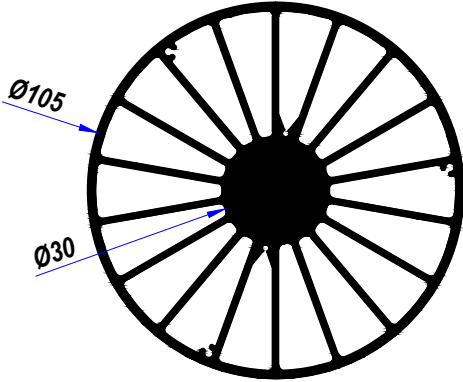

AYS - 110

Q 110 mm Alm. Prf.

ÖLÇEK 1/2

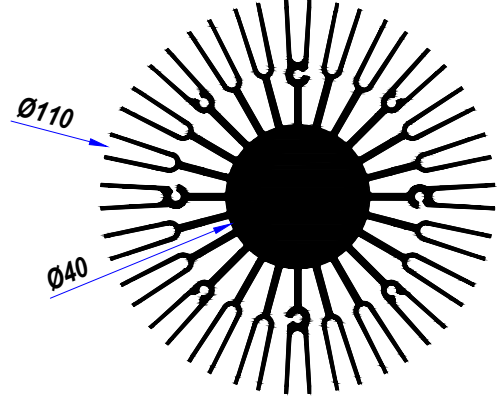

AYS - 115

Q 115 mm Alm. Prf.

ÖLÇEK 1/2

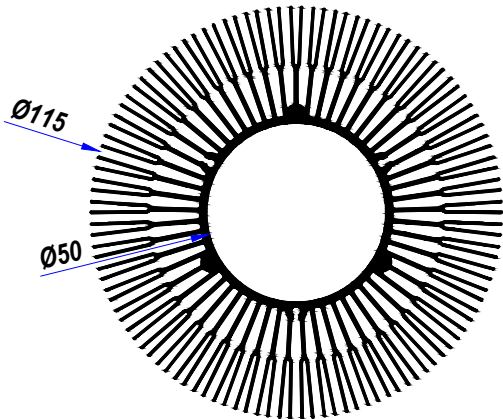

AYS - 120

Q 120 mm Alm. Prf.

ÖLÇEK 1/2

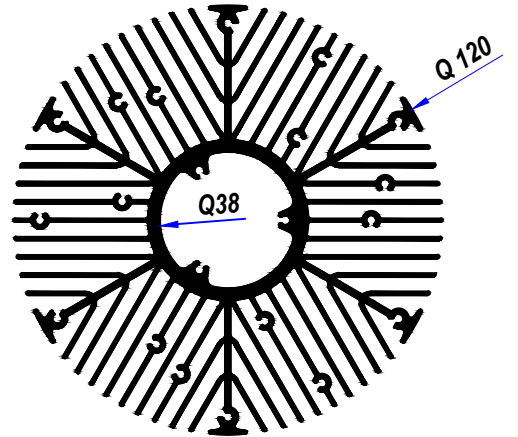

İSTENİLEN ÖLÇÜLERDE KESİM YAPILIR - ALM. FLANŞ YAPILIR - SİYAH ELOKSAL KAPLAMA YAPILIR  
All cutting dimensions can be done according to requirements-Doable black Anodize-Aluminium flange can be supplied

AYS - 121

Q 121 mm Alm. Prf.

ÖLÇEK 1/2

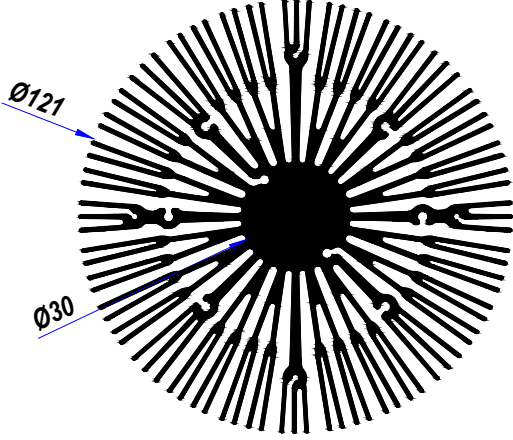

AYS - 125

Q 125 mm Alm. Prf.

ÖLÇEK 1/2

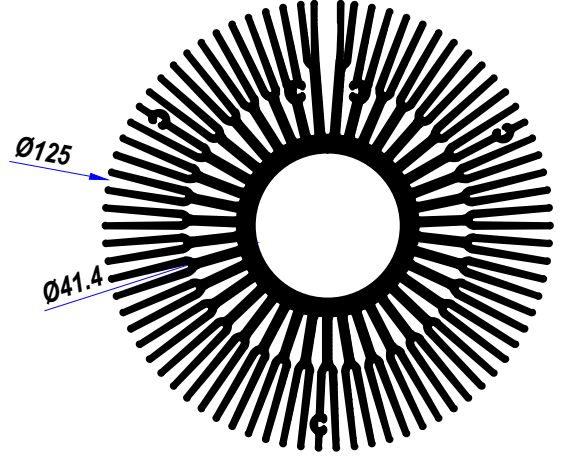

AYS - 130

Q 130 mm Alm. Prf.

ÖLÇEK 1/2

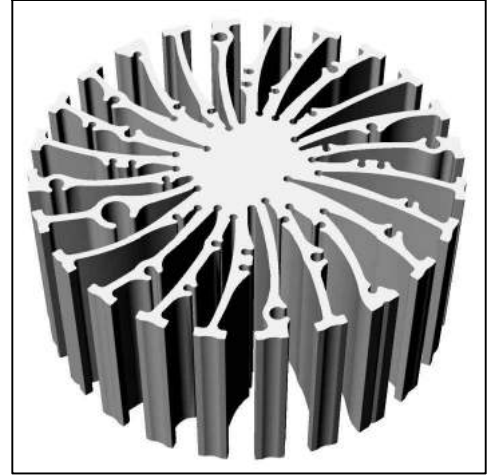
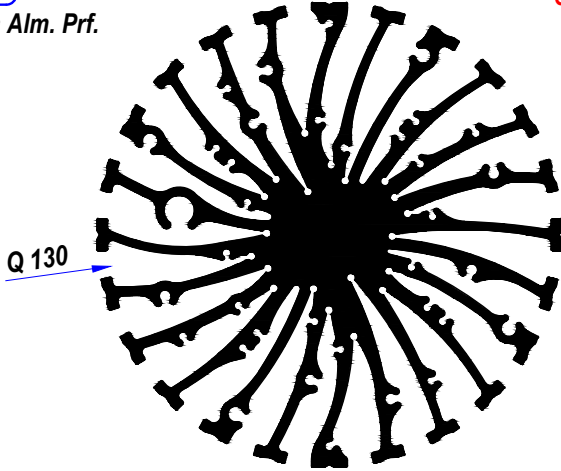

AYS - 134

Q 134,6 mm Alm. Prf.

ÖLÇEK 1/2

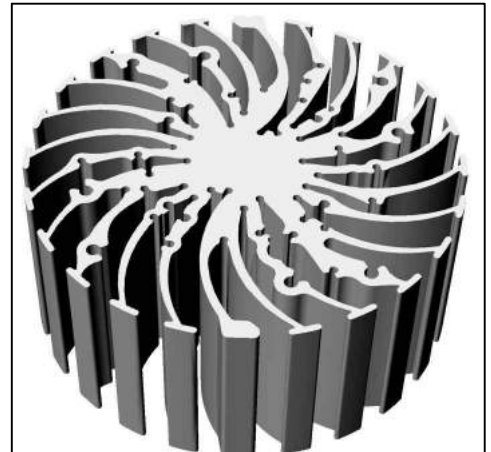
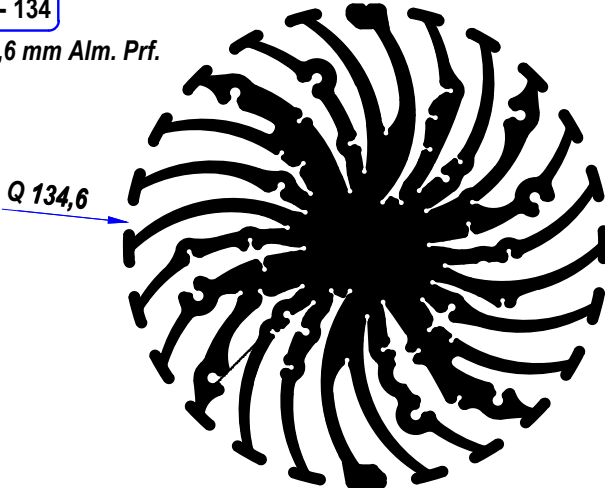

İSTENİLEN ÖLÇÜLERDE KESİM YAPILIR - ALM. FLANŞ YAPILIR - SİYAH ELOKSAL KAPLAMA YAPILIR  
All cutting dimensions can be done according to requirements-Doable black Anodize-Aluminium flange can be supplied

AYS - 138

Q 138 mm Alm. Prf.

ÖLÇEK 1/2

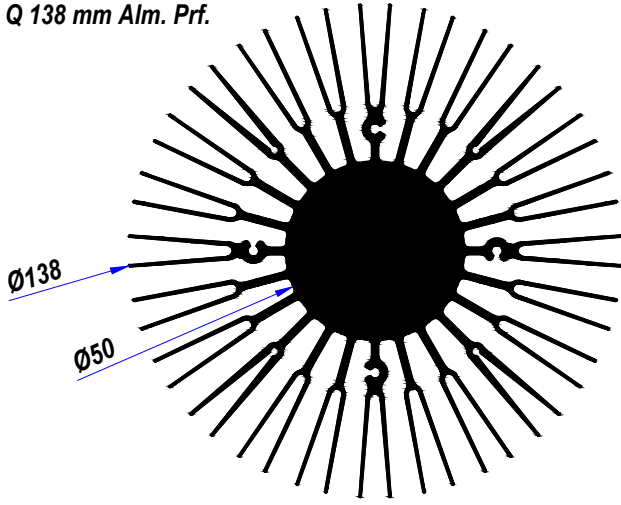

AYS - 140

Q 140 mm Alm. Prf.

ÖLÇEK 1/2

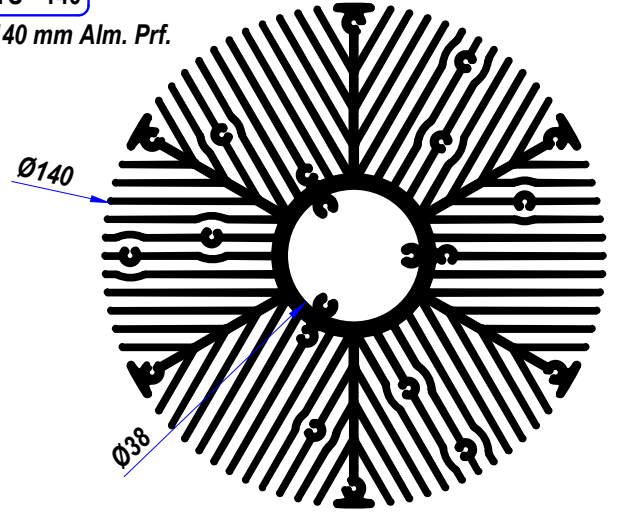

AYS - 150

Q 150 mm Alm. Prf.

ÖLÇEK 1/2

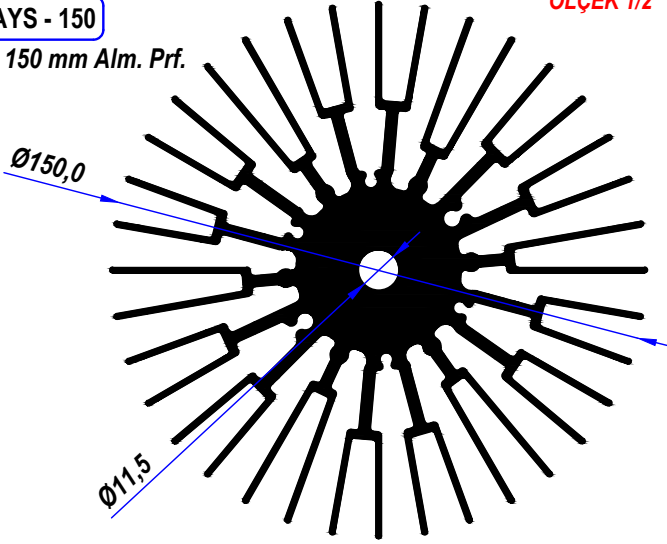

AYS-150 A

Q 150 mm Alm. Prf.

ÖLÇEK 1/2

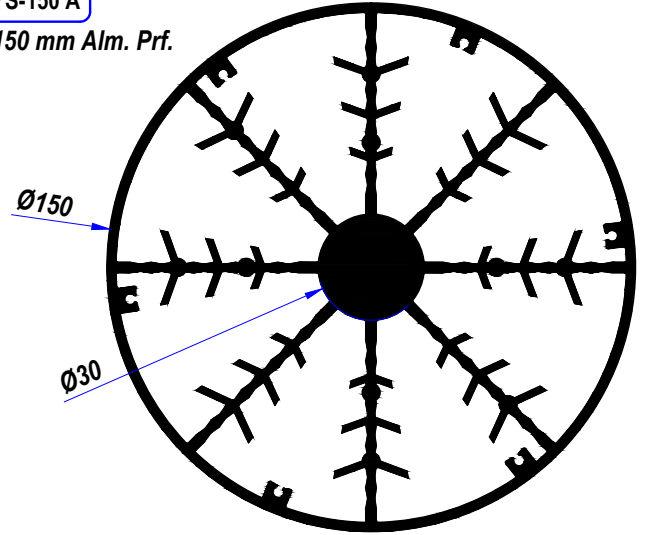

AYS - 160

Q 160 mm Alm. Prf.

ÖLÇEK 1/2

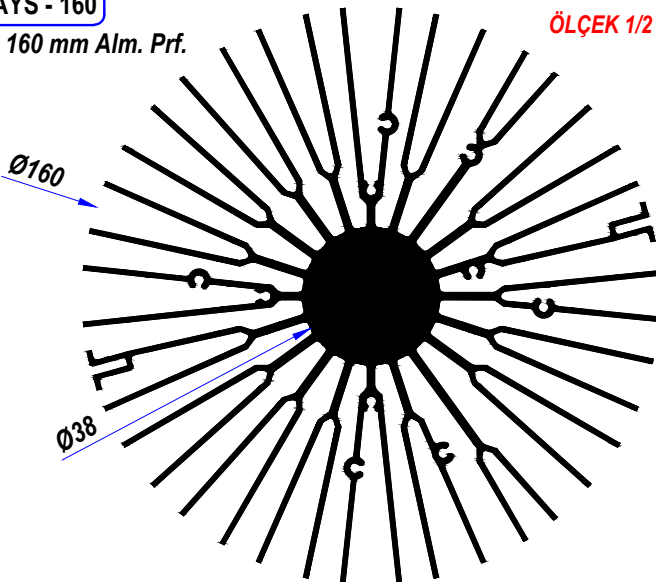

AYS - 170

Q 170,2 mm Alm. Prf.

ÖLÇEK 1/2

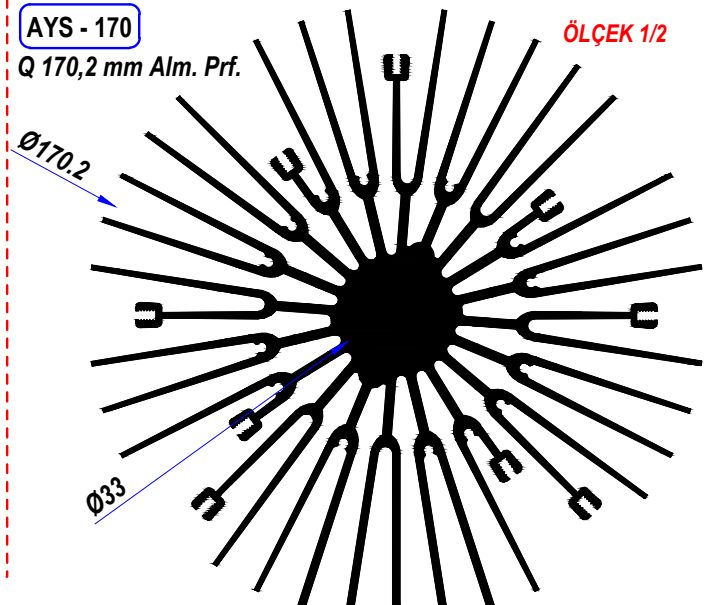

İSTENİLEN ÖLÇÜLERDE KESİM YAPILIR - ALM. FLANŞ YAPILIR - SİYAH ELOKSAL KAPLAMA YAPILIR

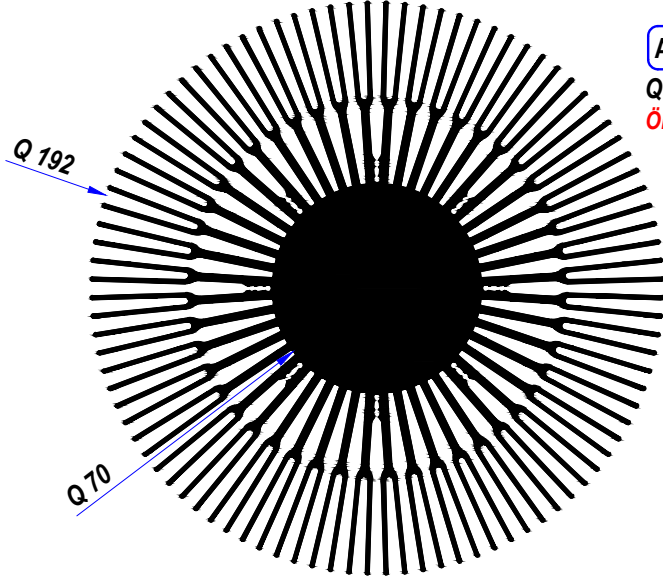

AYS - 192

Q 192 mm Alm. Prf.  
ÖLÇEK 1/3

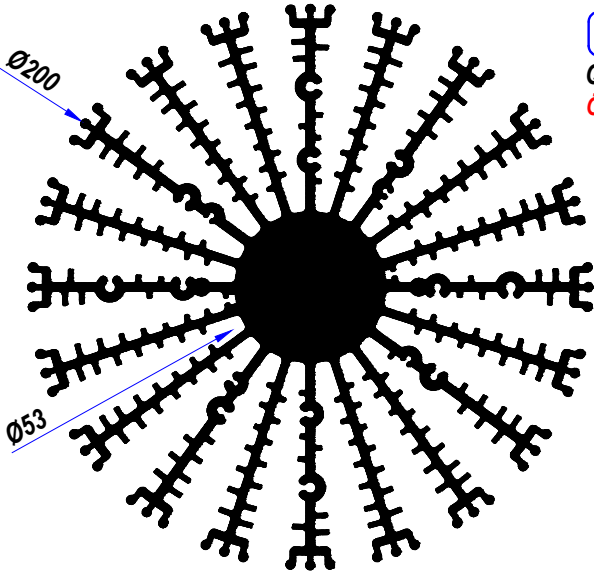
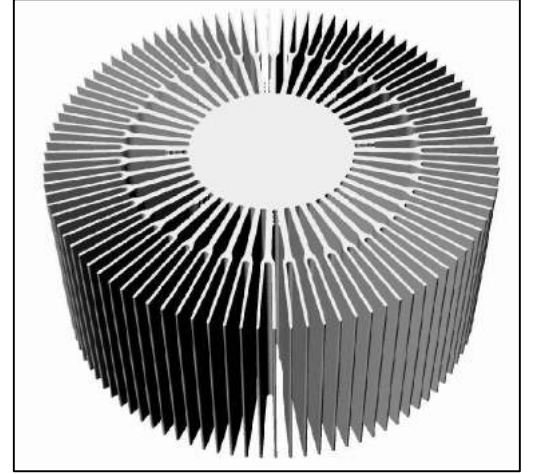

AYS - 200

Q 200 mm Alm. Prf.  
ÖLÇEK 1/3

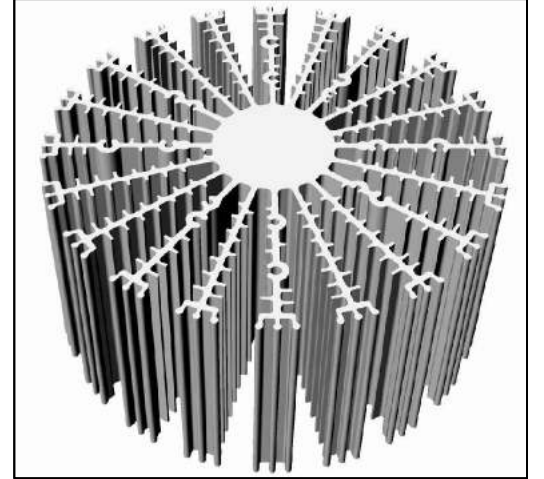

AYS - 230

Q 230 mm Alm. Prf.  
ÖLÇEK 1/3

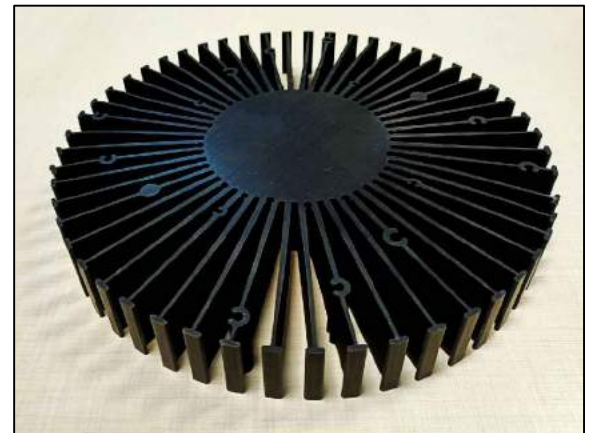
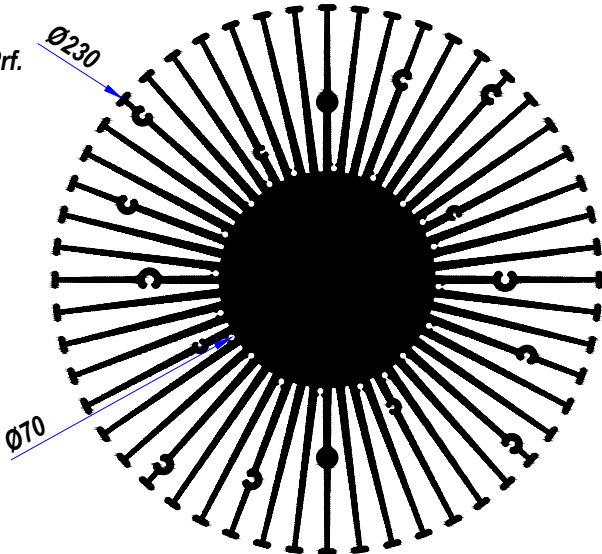

İSTENİLEN ÖLÇÜLERDE KESİM YAPILIR - ALM. FLANŞ YAPILIR - SİYAH ELOKSAL KAPLAMA YAPILIR  
All cutting dimensions can be done according to requirements-Doable black Anodize-Aluminium flange can be supplied

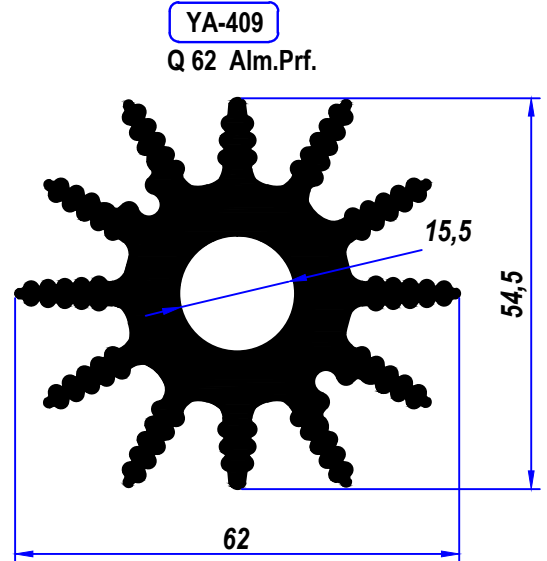
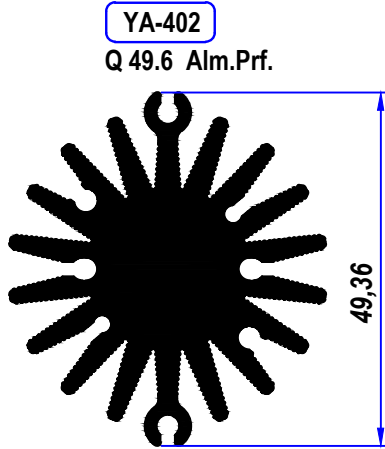
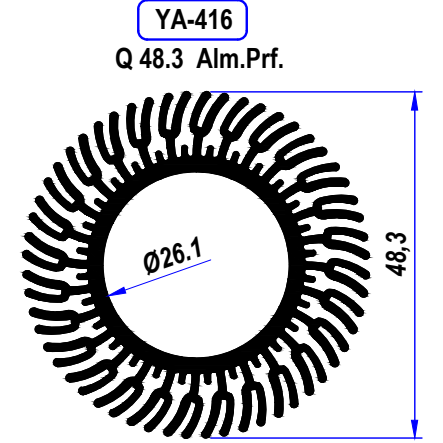
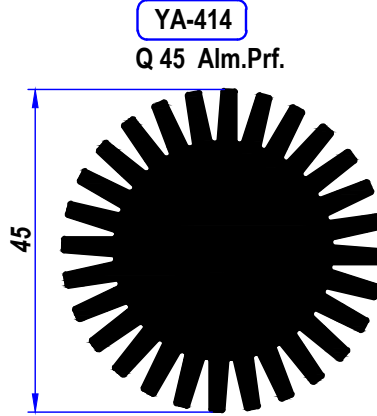
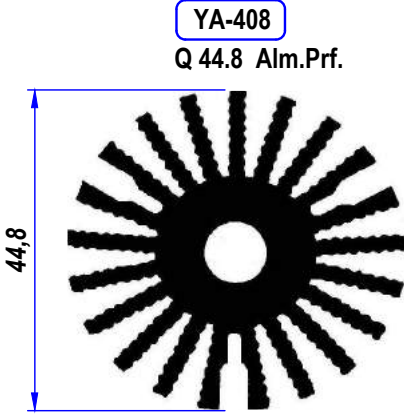
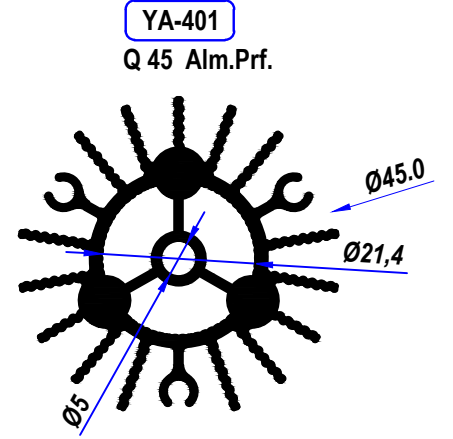
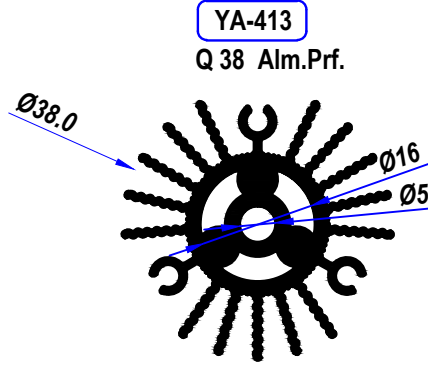
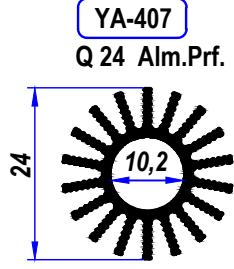

İSTENİLEN ÖLÇÜLERDE KESİM YAPILIR - ALM. FLAŞ YAPILIR - SİYAH ELOKSAL KAPLAMA YAPILIR  
All cutting dimensions can be done according to requirements-Doable black Anodize-Aluminium flange can be supplied

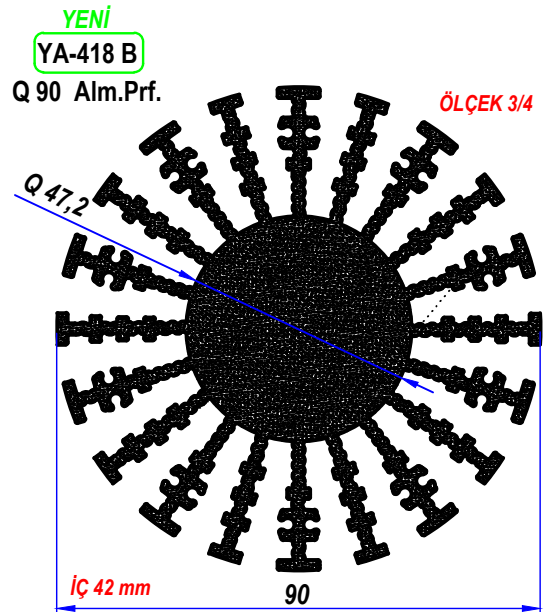
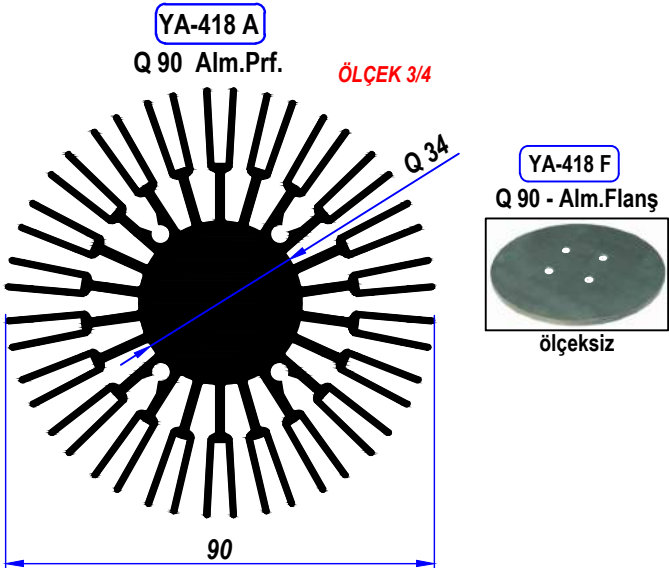
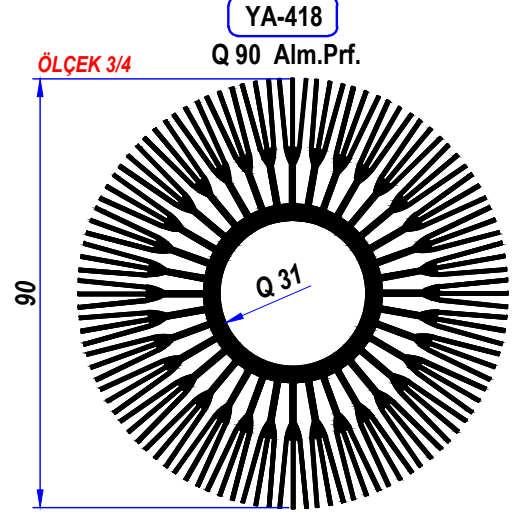
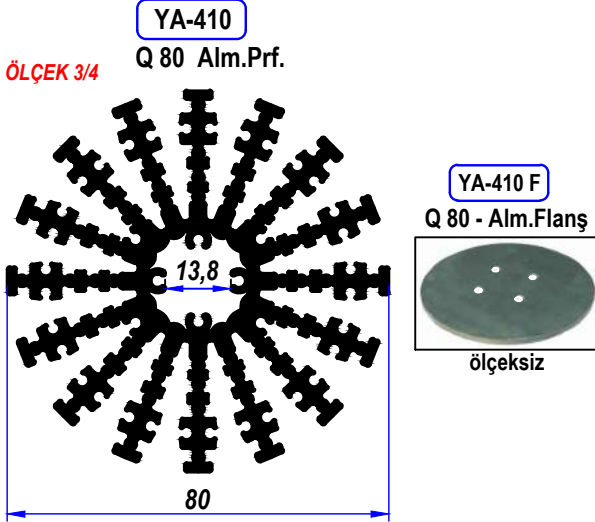
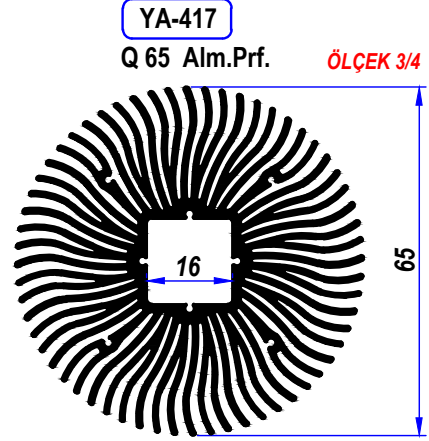
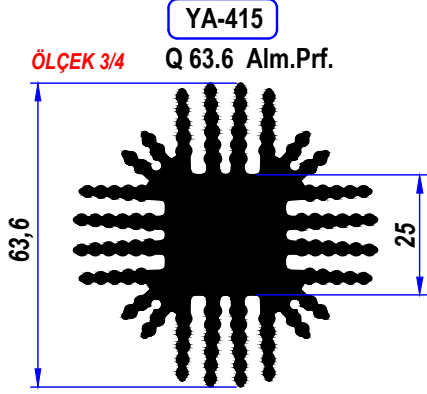

İSTENİLEN ÖLÇÜLERDE KESİM YAPILIR - ALM. FLAŞ YAPILIR - SİYAH ELOKSAL KAPLAMA YAPILIR  
All cutting dimensions can be done according to requirements-Doable black Anodize-Aluminium flange can be supplied

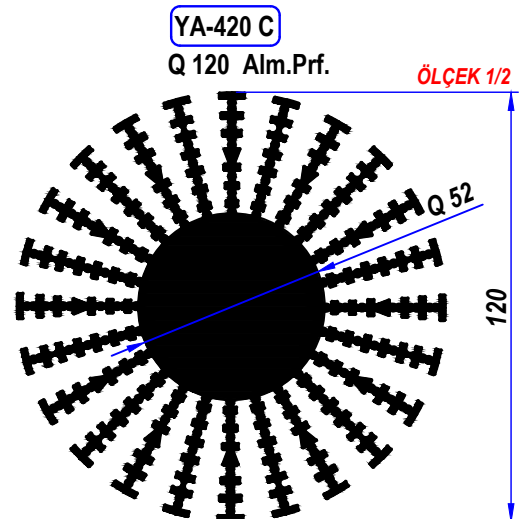
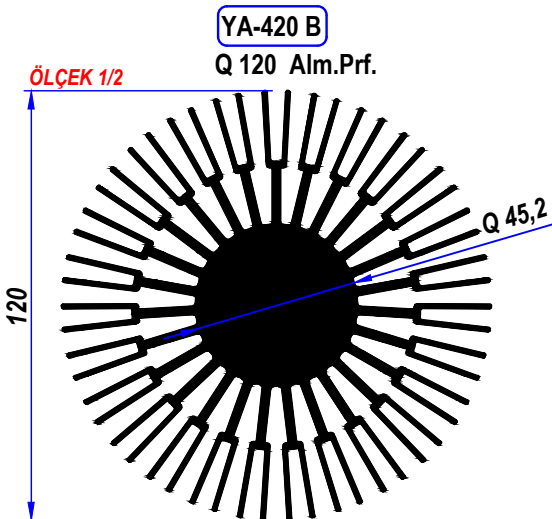
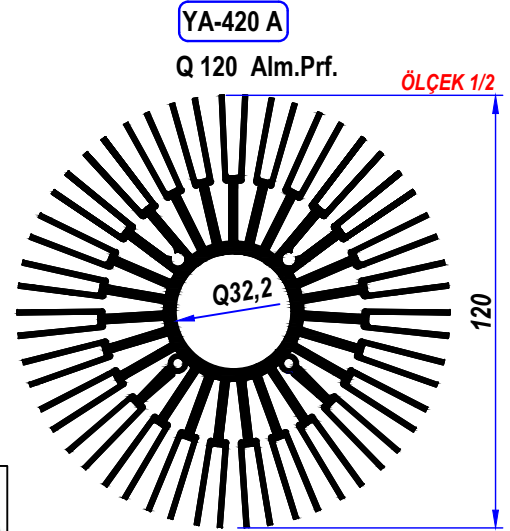
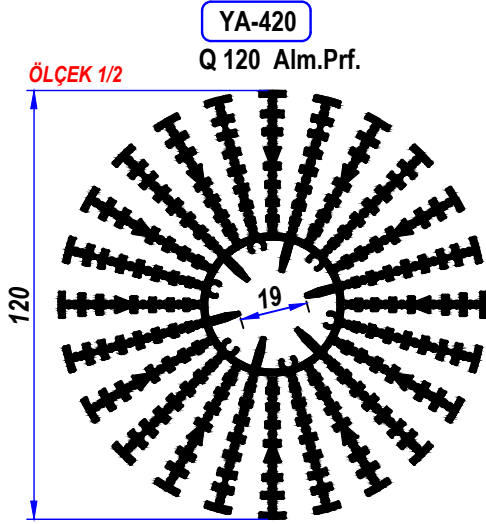
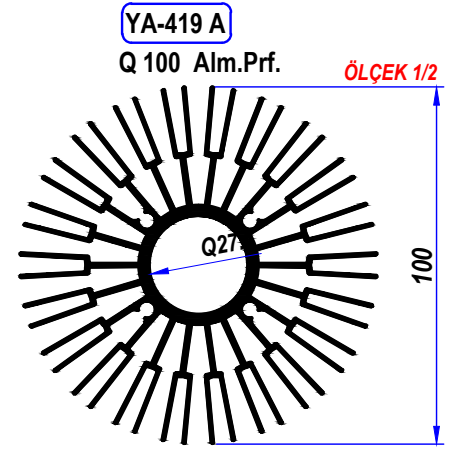
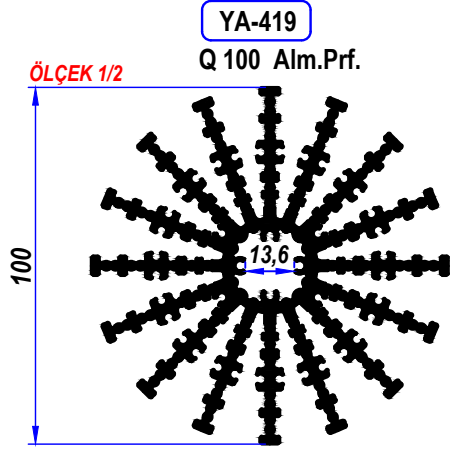

İSTENİLEN ÖLÇÜLERDE KESİM YAPILIR - ALM. FLANŞ YAPILIR - SİYAH ELOKSAL KAPLAMA YAPILIR  
All cutting dimensions can be done according to requirements-Doable black Anodize-Aluminium flange can be supplied

YA-411

Q 140 Alm.Prf.

ÖLÇEK 1/2

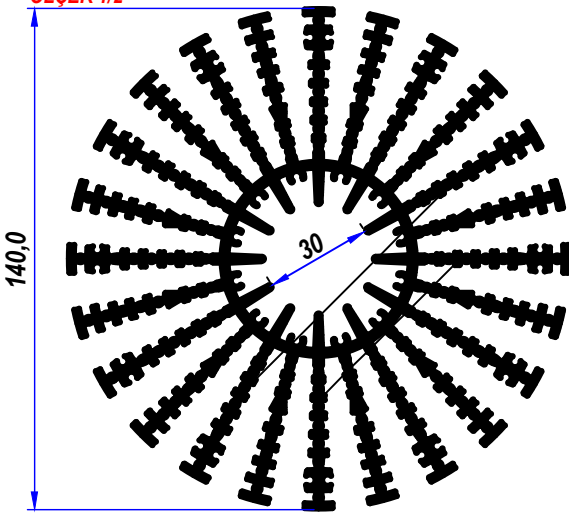

YA-411 F

Q 140 - Alm.Flaş



ölçeksiz

YA-411 A

Q 140 Alm.Prf.

ÖLÇEK 1/2

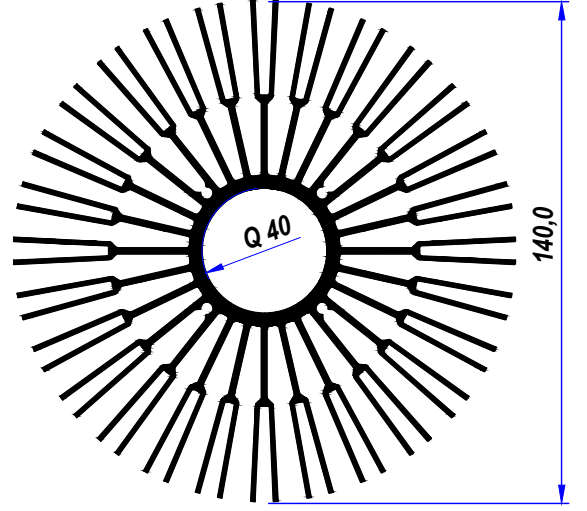

YA-412

Q 160 Alm.Prf.

ÖLÇEK 1/2

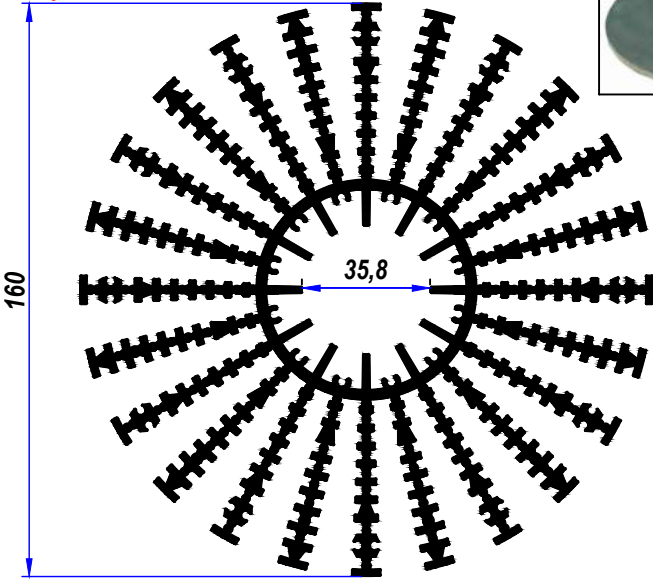

YA-412 F

Q 160 - Alm.Flaş

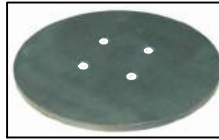

ölçeksiz

YA-412 A

Q 160 Alm.Prf.

ÖLÇEK 1/2

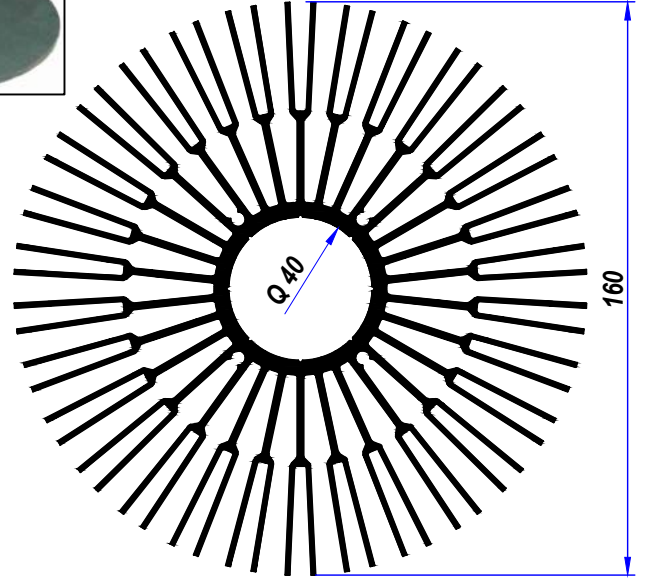

YA-423

Q 50 Alm.Prf.

ÖLÇEK 1/1

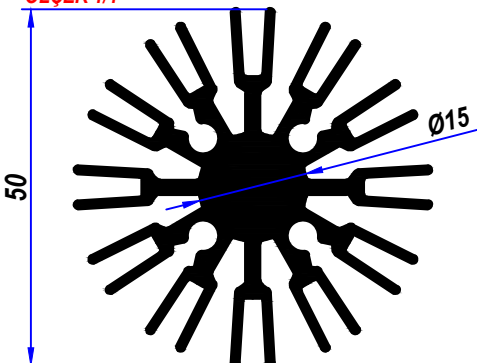

YA-424

Q 70 Alm.Prf.

ÖLÇEK 2/3

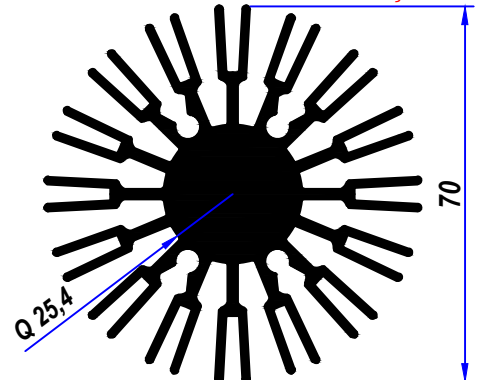

İSTENİLEN ÖLÇÜLERDE KESİM YAPILIR - ALM. FLAŞ YAPILIR - SİYAH ELOKSAL KAPLAMA YAPILIR  
All cutting dimensions can be done according to requirements-Doable black Anodize-Aluminium flange can be supplied

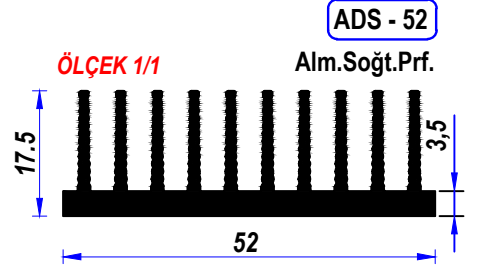
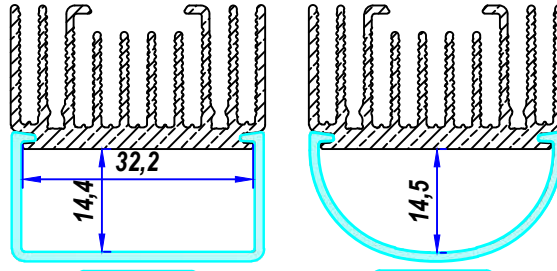
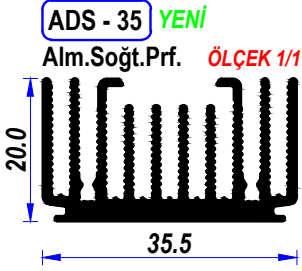

**YA-253 M** Minik Ayak Seti

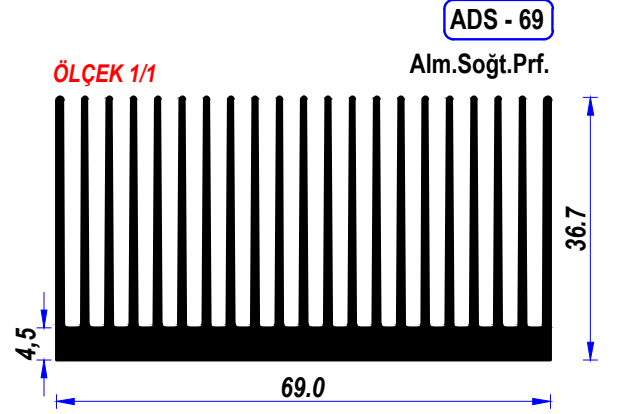
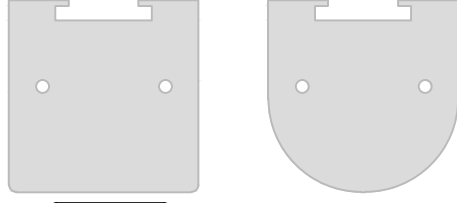
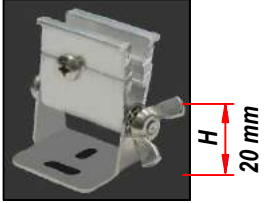

**ADS - 70** **YENİ**

Alm.Soğt.Prf.

**ÖLÇEK 1/1**

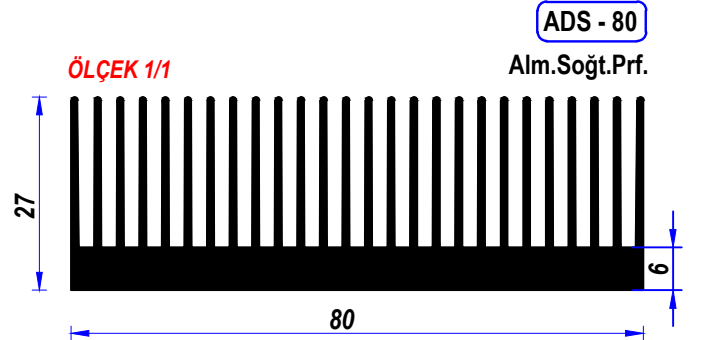
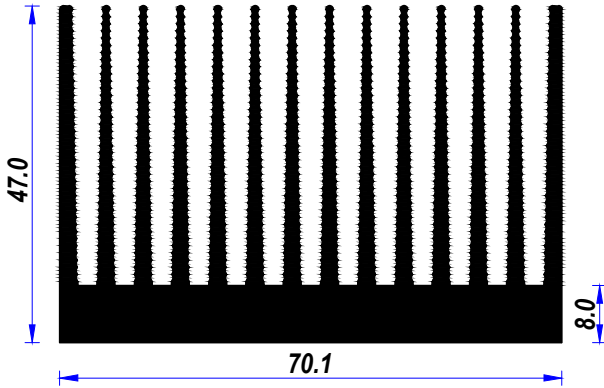

**ADS-80 A** **YENİ**

Alm.Soğt.Prf.

**Çiftli kullanım**

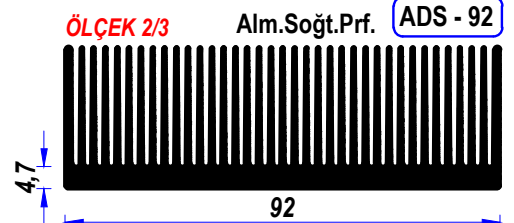
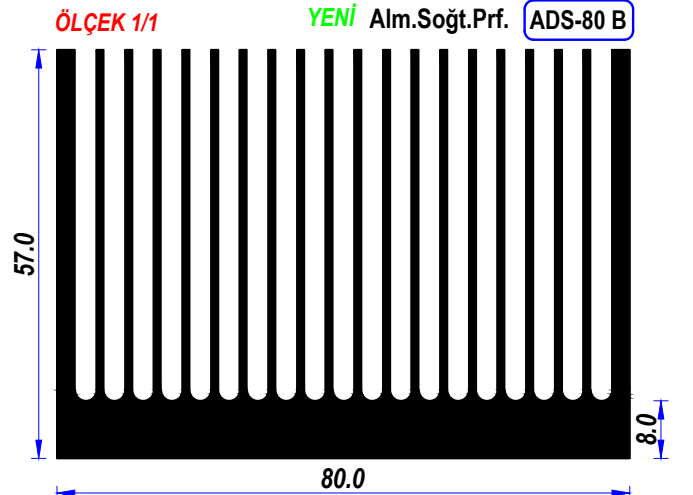
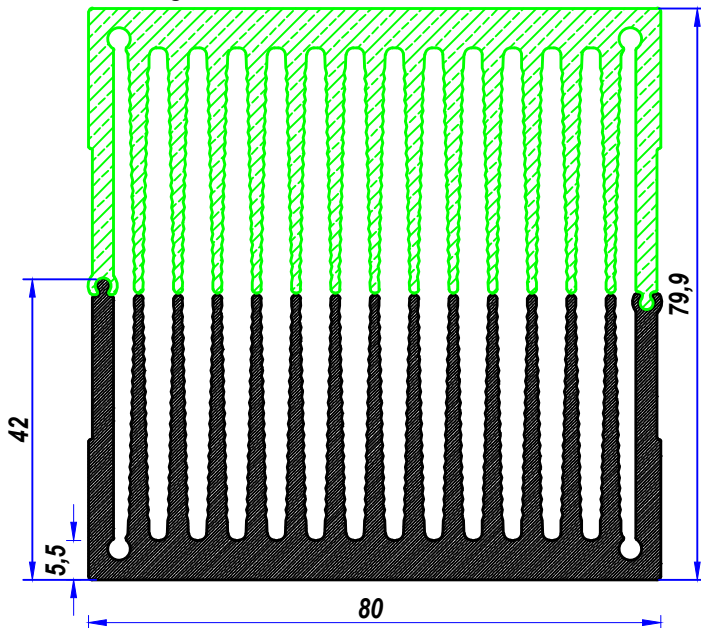

ADS - 95 YENİ

Alm.Soğt.Prf.

ÖLÇEK 2/3

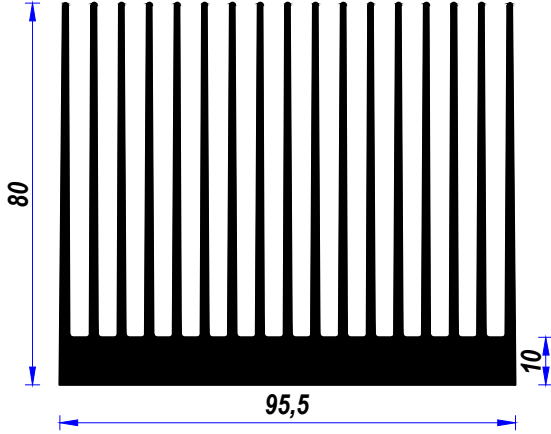

ADS-101 YENİ

Alm.Soğt.Prf.

ÖLÇEK 3/4

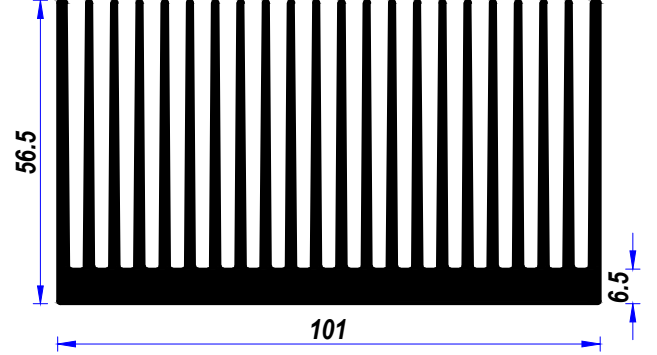

ADS - 104

Alm.Soğt.Prf.

ÖLÇEK 3/4

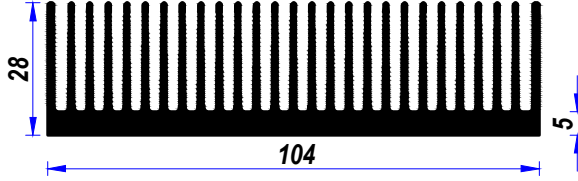

ADS - 114

Alm.Soğt.Prf.

ÖLÇEK 3/4

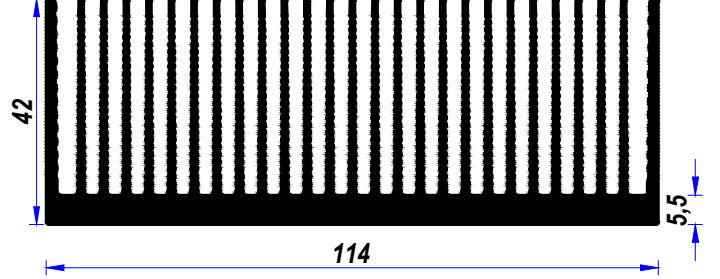

ADS - 115

Alm.Soğt.Prf.

ÖLÇEK 3/4

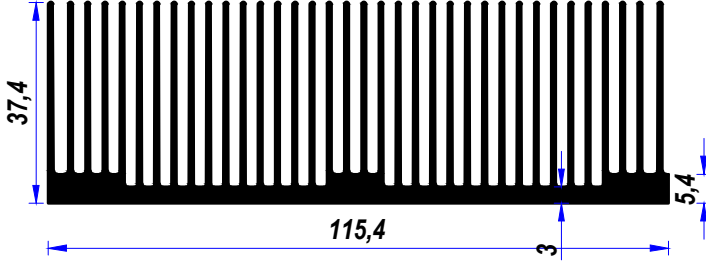

ADS - 117 YENİ

Alm.Soğt.Prf.

Çiftli kullanım

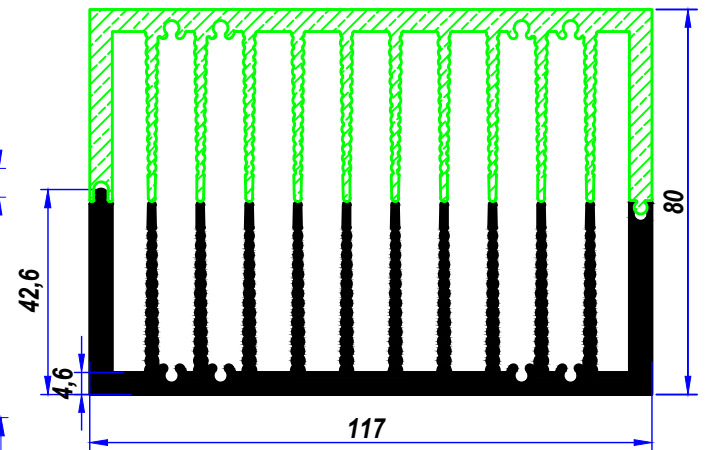

ADS - 120

Alm.Soğt.Prf.

ÖLÇEK 3/4

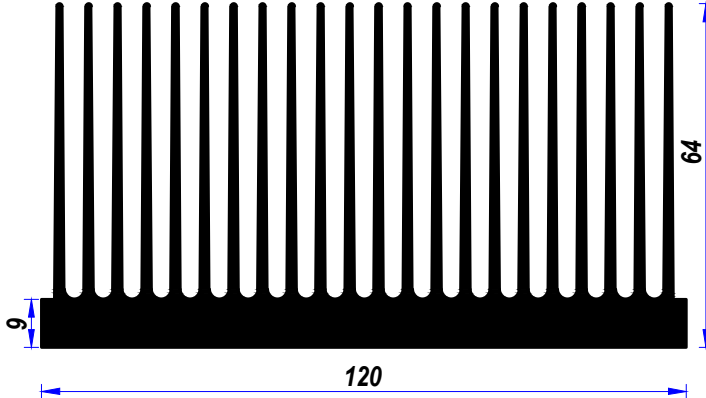

ADS - 122

Alm.Soğt.Prf.

ÖLÇEK 3/4

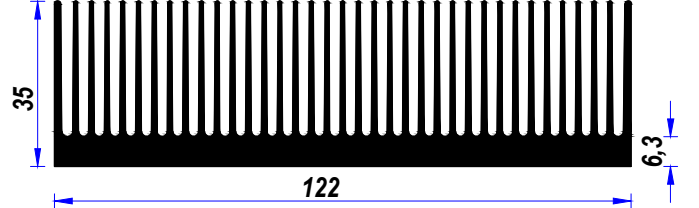

İSTENİLEN ÖLÇÜLERDE KESİM ve SİYAH ELOKSALLI KAPLAMA YAPILIR  
All cutting dimensions can be done according to requirements and Double black anodize

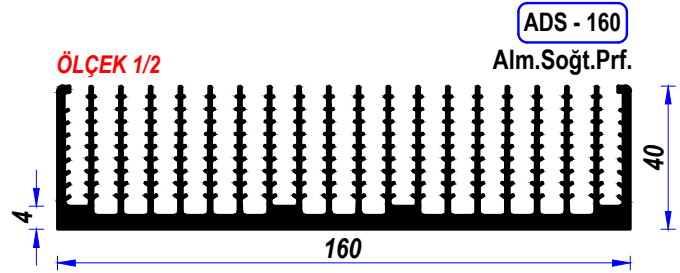
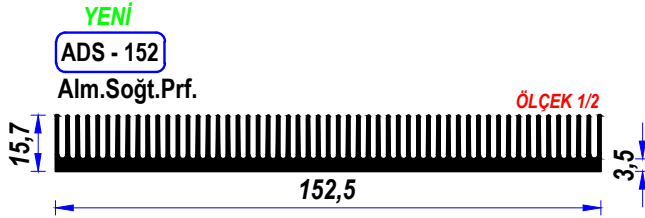
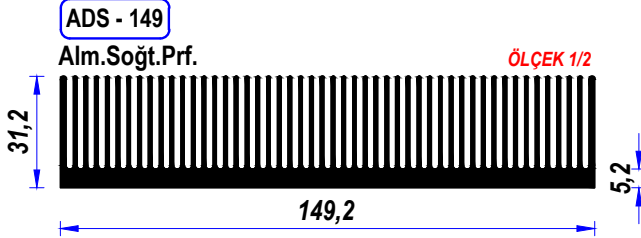
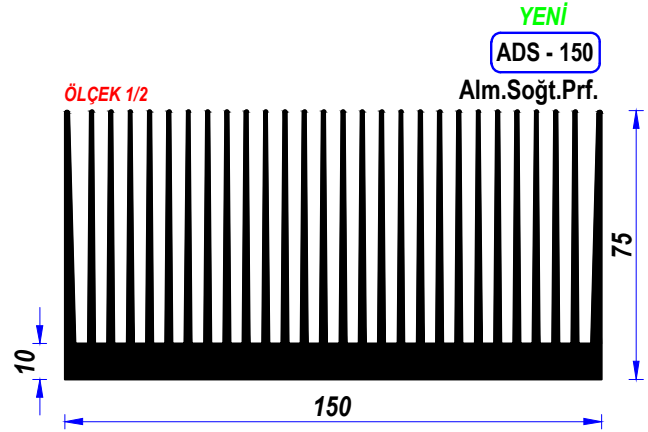
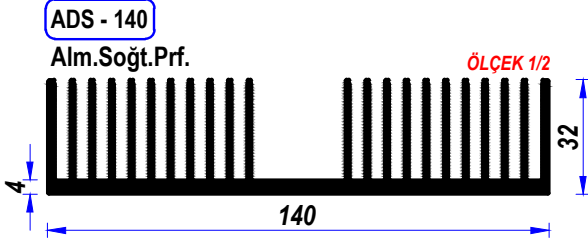
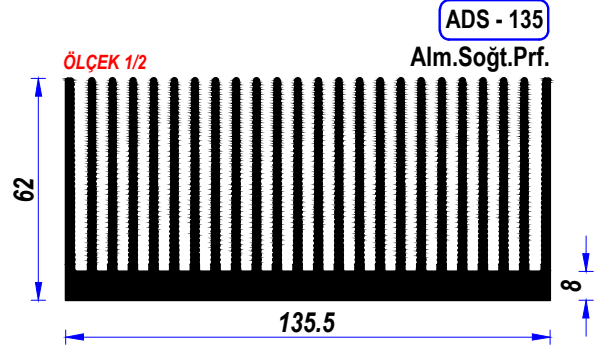
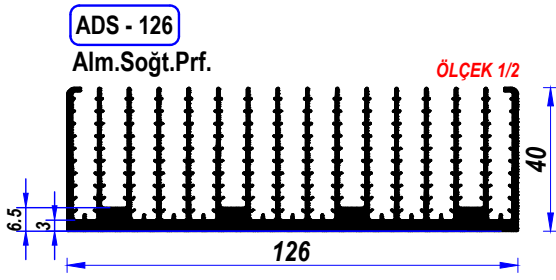

YA-1310 A PC. cam, Kanopi kasasına uygun, alm.prf.  
YA-173 A Modül Lense, Sokak Arm. ve prj kasasına uygun, alm. prf.

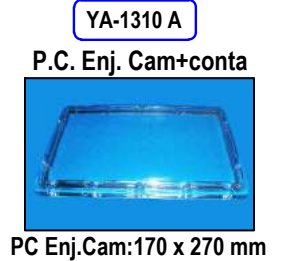
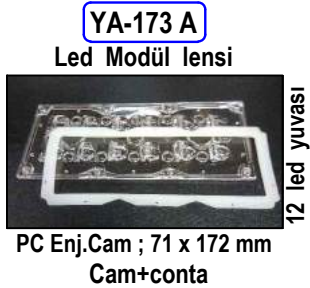

İSTENİLEN ÖLÇÜLERDE KESİM ve SİYAH ELOKSALLI KAPLAMA YAPILIR  
All cutting dimensions can be done according to requirements and Double black anodize

YENİ

ADS - 178

Alm.Soğt.Prf.  
ÖLÇEK 1/2

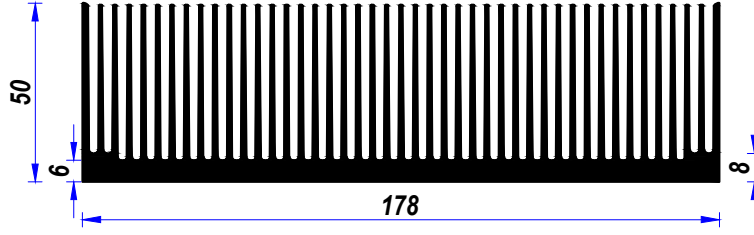

ADS - 180

Alm.Soğt.Prf.  
ÖLÇEK 1/2

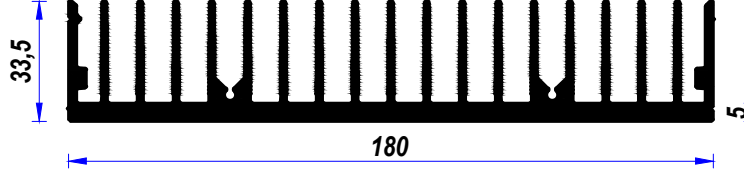

ADS - 190

Alm.Soğt.Prf.  
ÖLÇEK 1/2

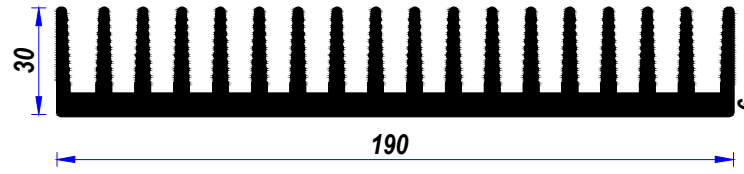

YENİ

ADS - 200

Alm.Soğt.Prf.  
ÖLÇEK 1/2

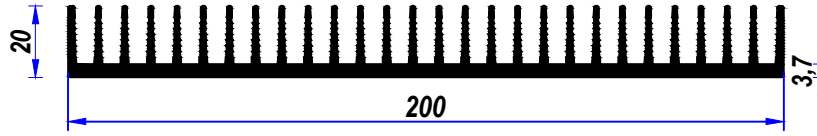

YENİ

ADS - 209

Alm.Soğt.Prf.  
ÖLÇEK 1/2

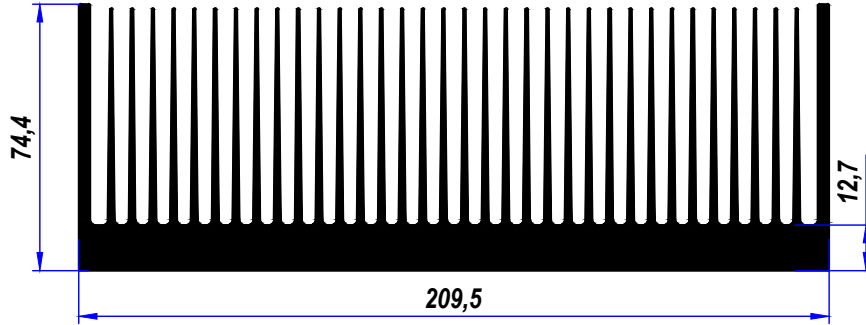

ADS - 210

Alm.Soğt.Prf.  
ÖLÇEK 1/2

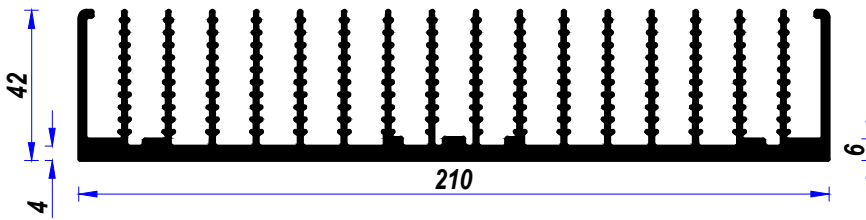

ADS - 210 A

Alm.Soğt.Prf.  
ÖLÇEK 1/2

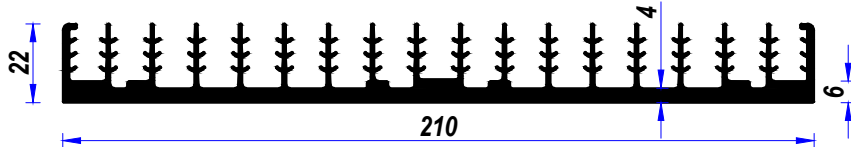

ADS - 223

Alm.Soğt.Prf.  
ÖLÇEK 1/2

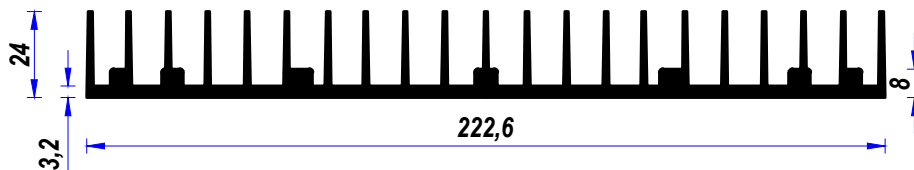

İSTENİLEN ÖLÇÜLERDE KESİM ve SİYAH ELOKSALLI KAPLAMA YAPILIR  
All cutting dimensions can be done according to requirements and Double black anodize

**YENİ**  
**ADS - 244**  
Alm.Soğt.Prf.  
ÖLÇEK 1/2

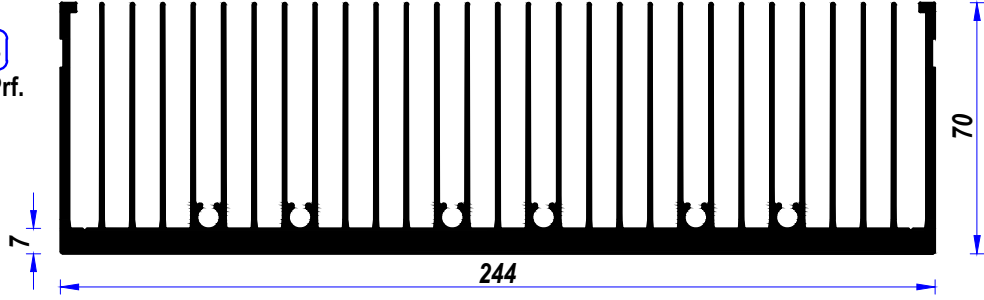

**ADS - 250**  
Alm.Soğt.Prf.  
ÖLÇEK 1/2

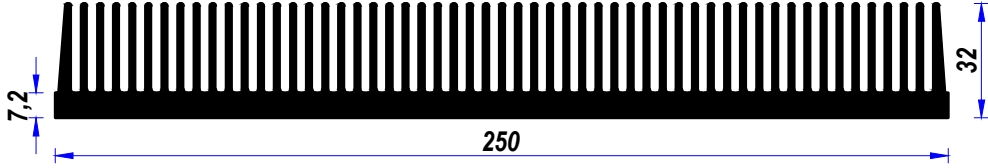

**ADS - 267**  
Alm.Soğt.Prf.  
ÖLÇEK 1/2

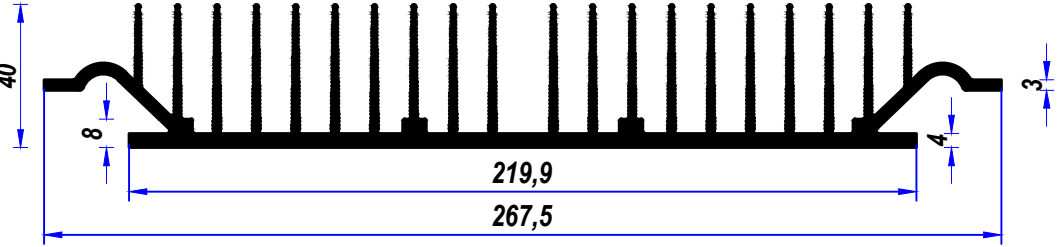

*Kanopi kasasına uygun, alm.prof. ve PC cam*

**ADS - 278**  
Alm.Soğt.Prf.  
ÖLÇEK 1/2

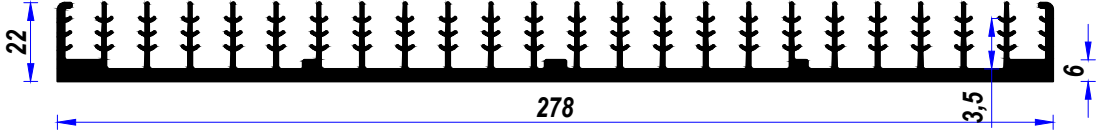

**Ekonomik Alm.Soğt.Prf.**



100 waat

**YA-1311 A**

**P.C. Enj. Cam+conta**

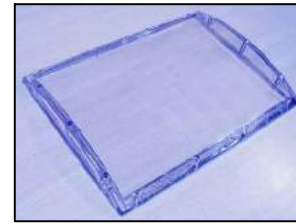

CAM ; 270 x 368 mm

**ADS - 280**  
Alm.Soğt.Prf.  
ÖLÇEK 1/2

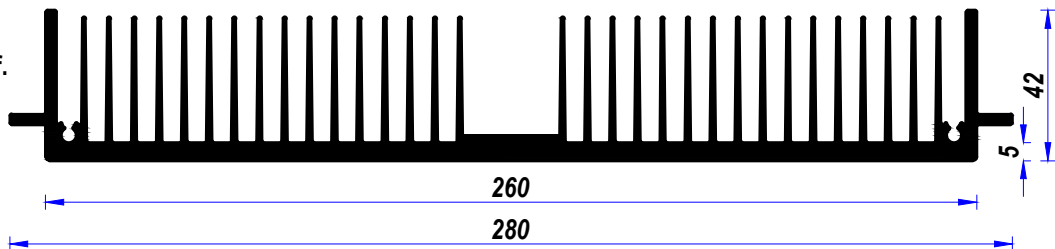

**İSTENİLEN ÖLÇÜLERDE KESİM ve SİYAH ELOKSALLI KAPLAMA YAPILIR**  
All cutting dimensions can be done according to requirements and Doable black anodize

ADS - 296  
Alm.Soğt.Prf.  
ÖLÇEK 1/2

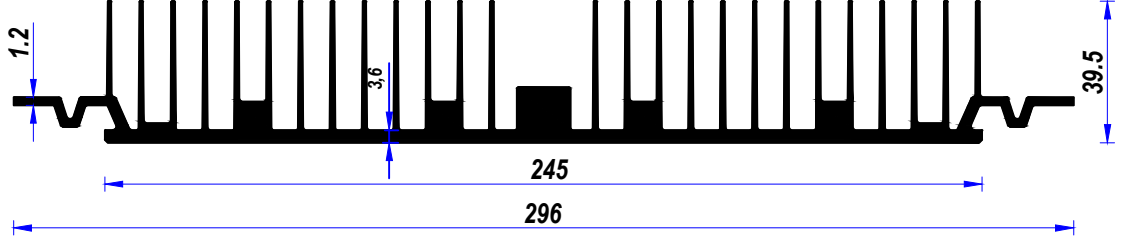

ADS-296 A  
Alm.Soğt.Prf.  
ÖLÇEK 1/2

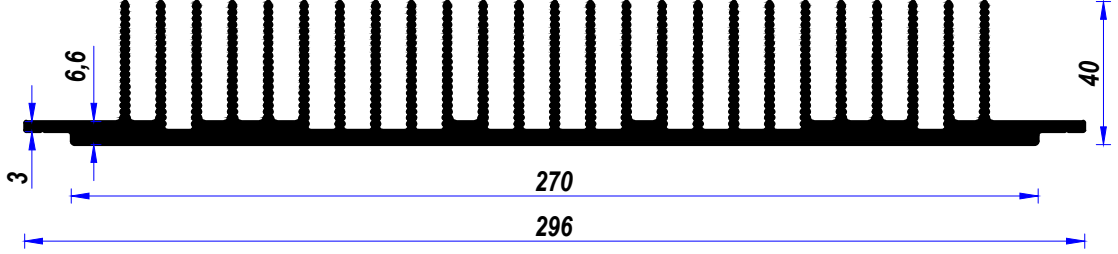

ADS - 298  
Alm.Soğt.Prf.  
ÖLÇEK 1/2

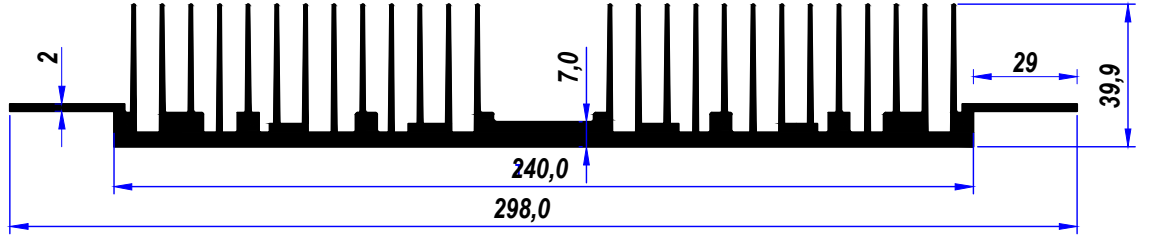

ADS-298 A  
Alm.Soğt.Prf.  
ÖLÇEK 1/3

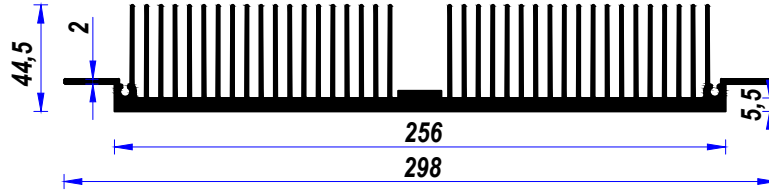

ADS-300 A  
Alm.Soğt.Prf.  
ÖLÇEK 1/3

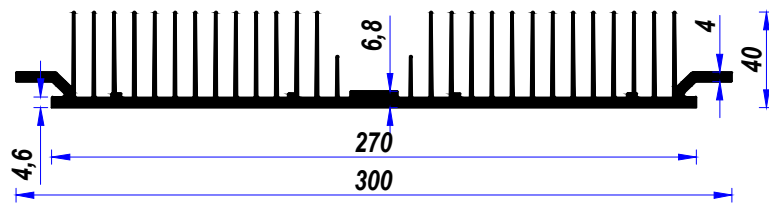

YA-1311 A

P.C. Enj. Cam+conta

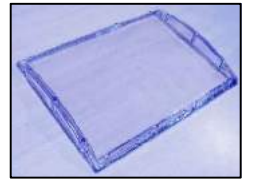

CAM ; 270 x 368 mm

ADS - 305  
Alm.Soğt.Prf.  
ÖLÇEK 1/3

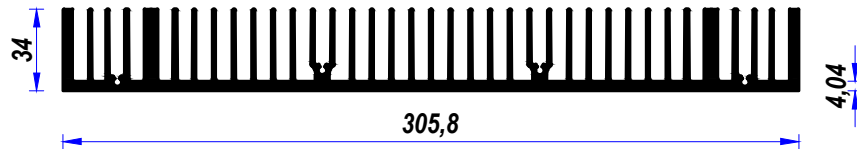

ADS - 307  
Alm.Soğt.Prf.  
ÖLÇEK 1/3

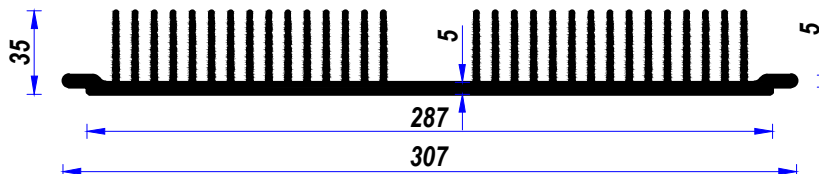

Bu ürün, YA-1311 A PC ile birlikte, kanopi kasası yapımına uygundur

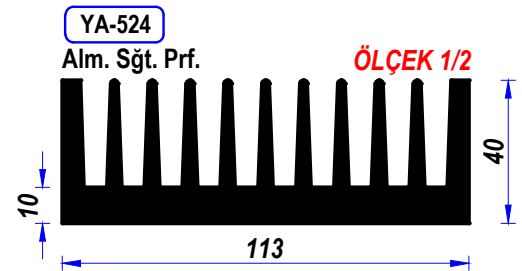
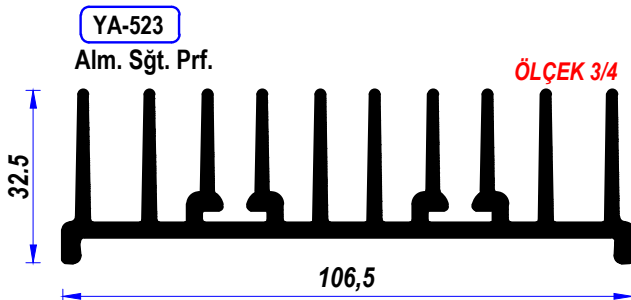
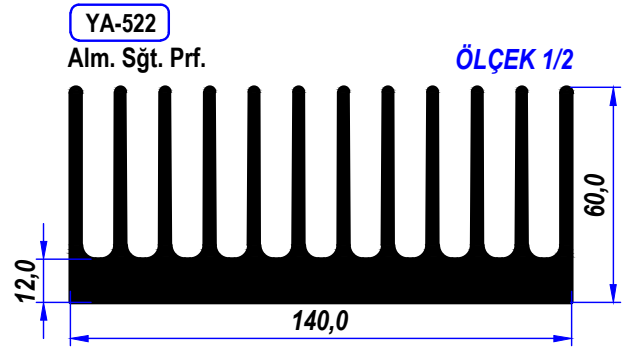
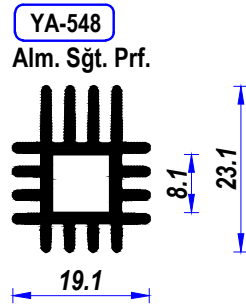
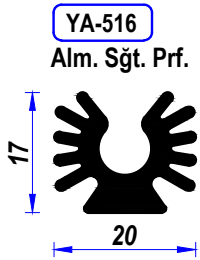
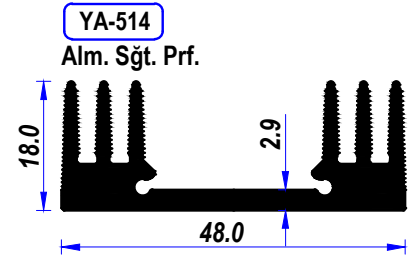
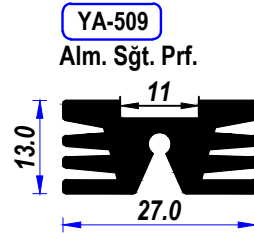
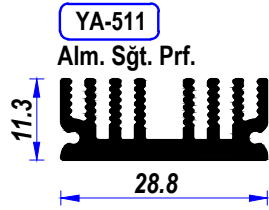
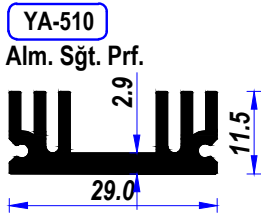
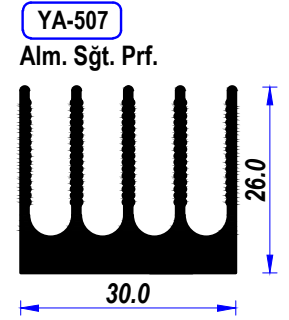
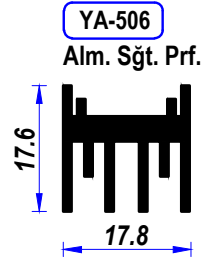
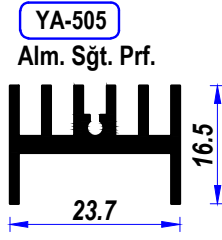
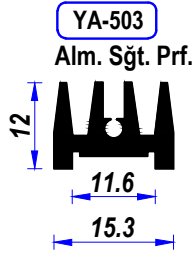
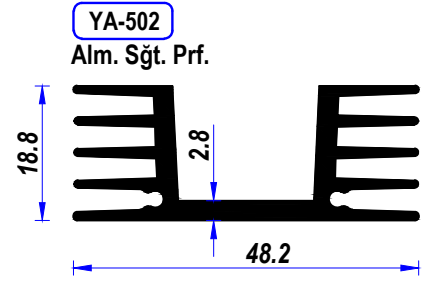
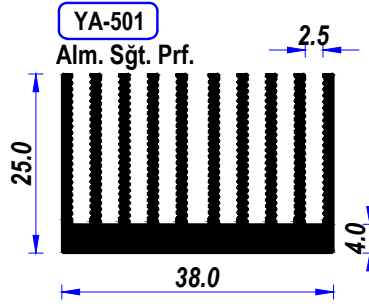
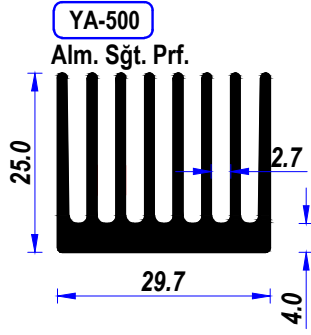

İSTENİLEN ÖLÇÜLERDE KESİM ve SİYAH ELOKSALLI KAPLAMA YAPILIR  
All cutting dimensions can be done according to requirements and Double black anodize

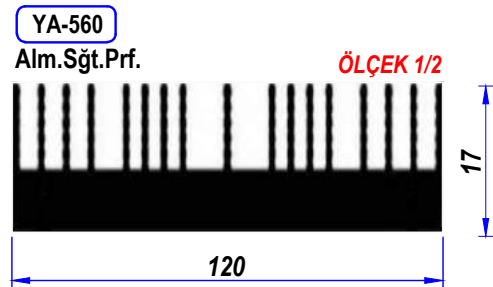
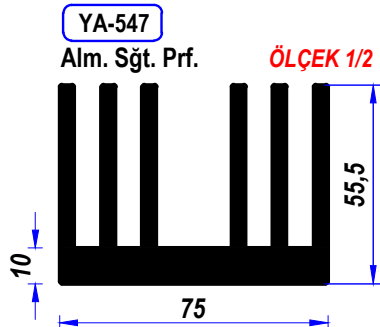
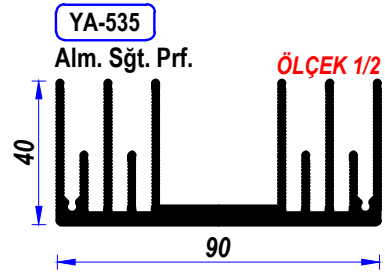
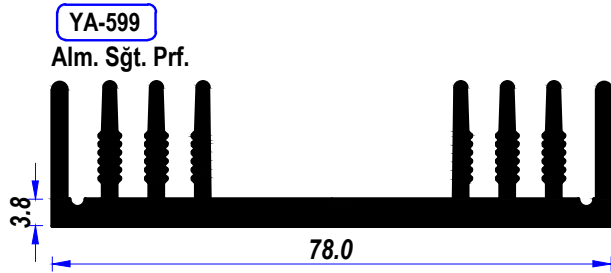
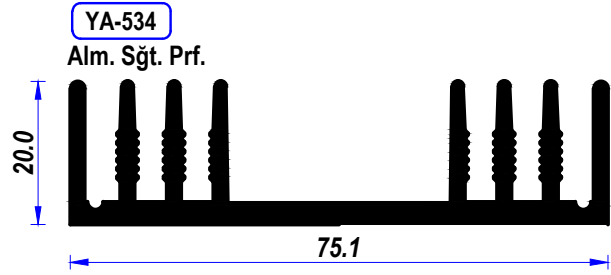
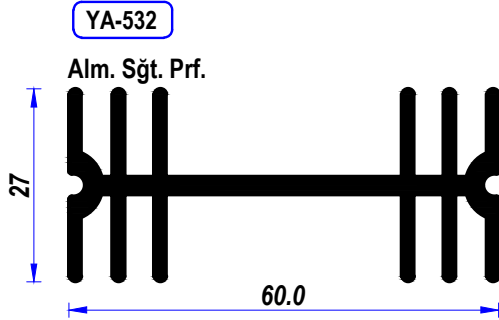
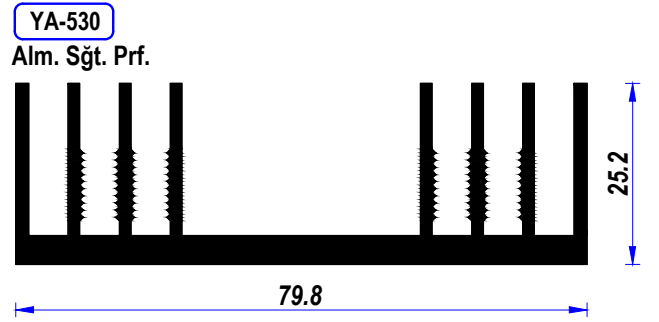
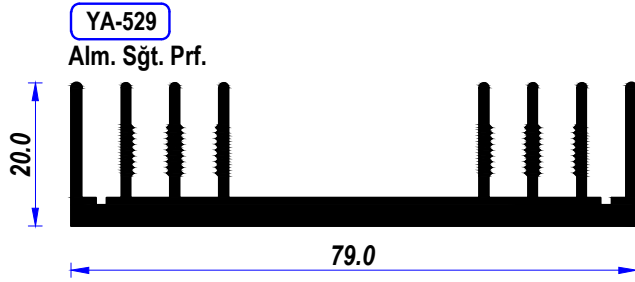
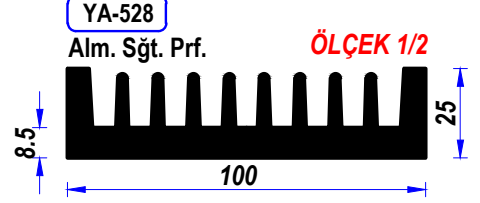
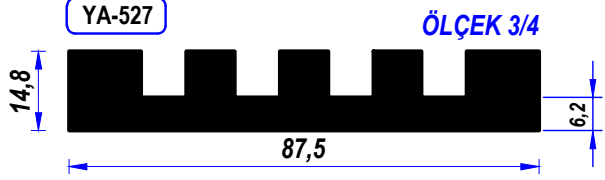
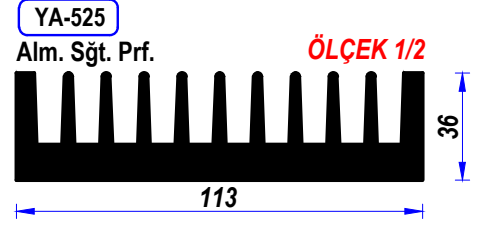
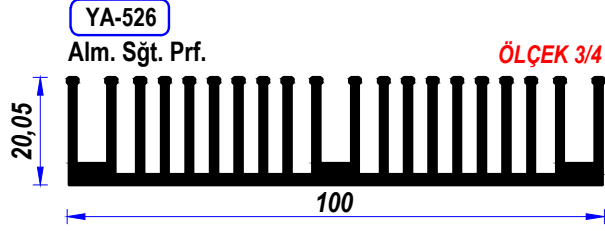

**İSTENİLEN ÖLÇÜLERDE KESİM ve SİYAH ELOKSALLI KAPLAMA YAPILIR**  
All cutting dimensions can be done according to requirements and Double black anodize

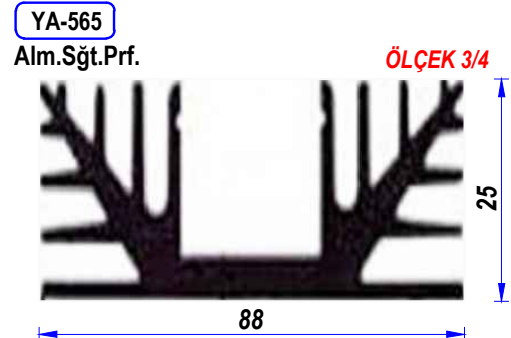
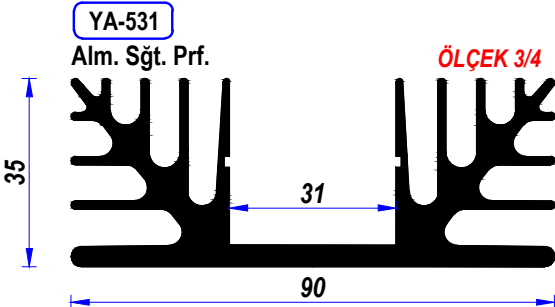
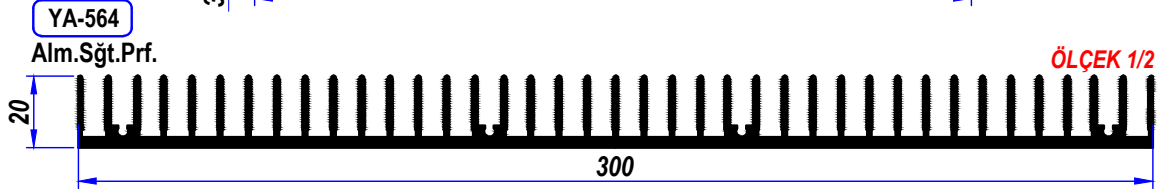
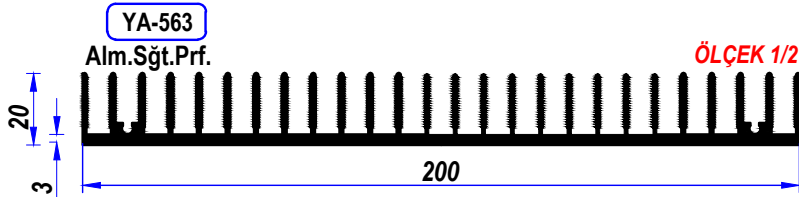
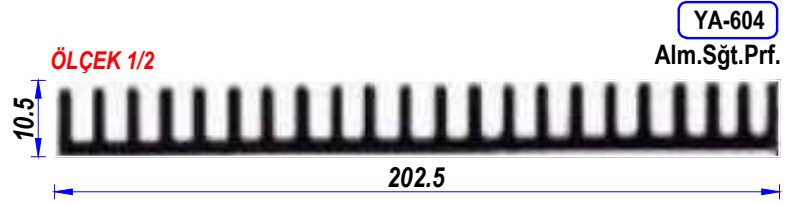
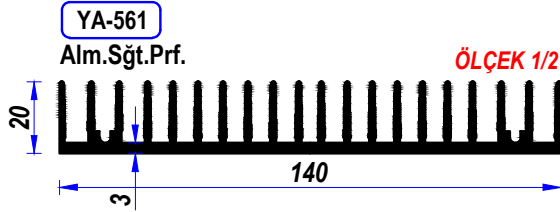
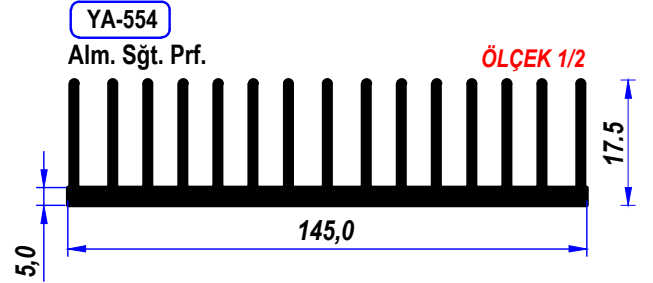
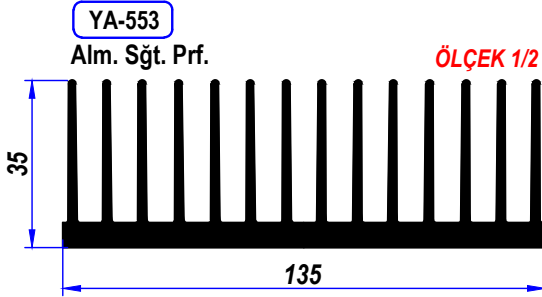
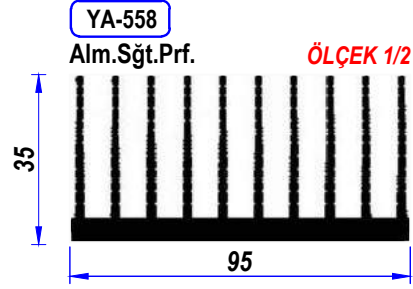
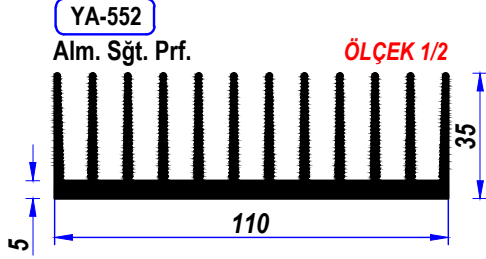
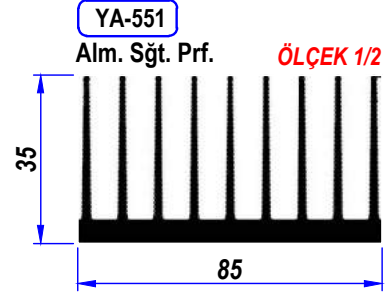
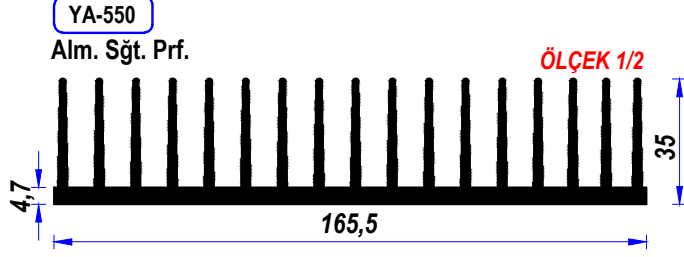

İSTENİLEN ÖLÇÜLERDE KESİM ve SİYAH ELOKSALLI KAPLAMA YAPILIR  
All cutting dimensions can be done according to requirements and Double black anodize

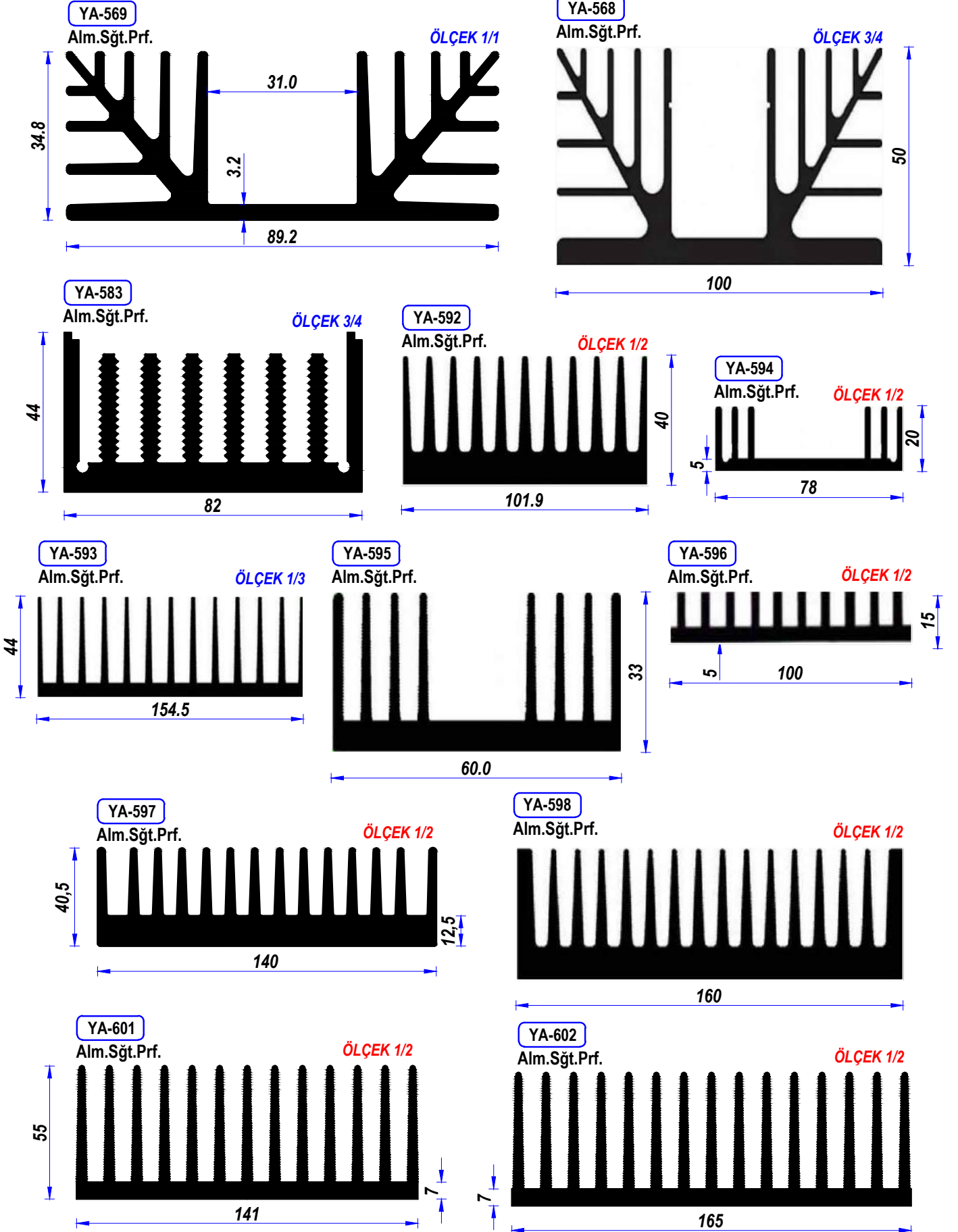

İSTENİLEN ÖLÇÜLERDE KESİM ve SİYAH ELOKSALLI KAPLAMA YAPILIR  
All cutting dimensions can be done according to requirements and Double black anodize

YA-600

Alm.Sğt.Prf.

ÖLÇEK 1/3

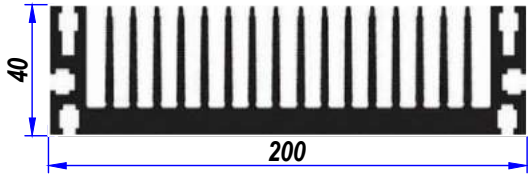

YA-603

Alm.Sğt.Prf.

ÖLÇEK 1/3

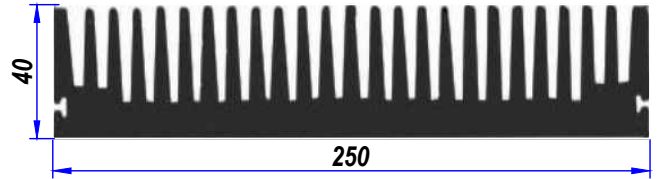

YA-613

Alm.Sğt.Prf.

ÖLÇEK 1/2

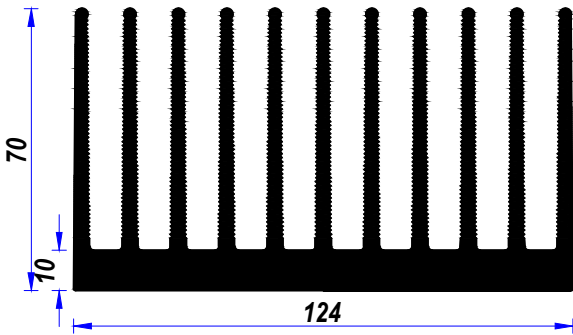

YA-607

Alm.Sğt.Prf.

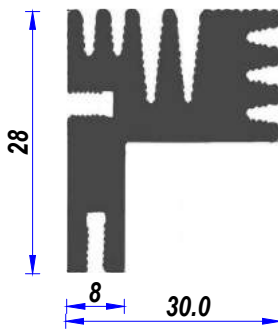

YA-620

Alm.Sğt.Prf.

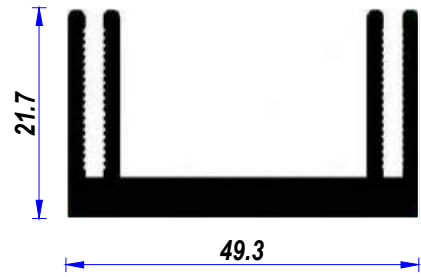

YA-625

Alm.Sğt.Prf.

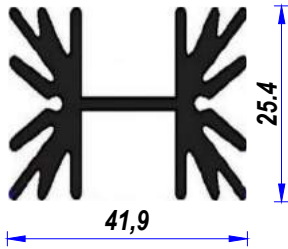

YA-626

Alm.Sğt.Prf.

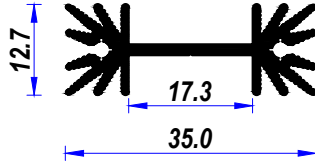

YA-627

Alm.Sğt.Prf.

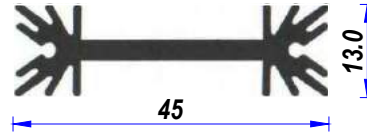

YA-623

Alm.Sğt.Prf.



YA-624

Alm.Sğt.Prf.

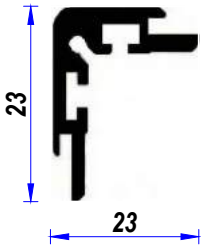

YA-653

Alm.Sğt.Prf.

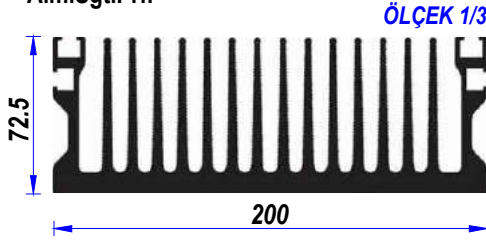

ÖLÇEK 1/3

YA-665

Alm.Sğt.Prf.

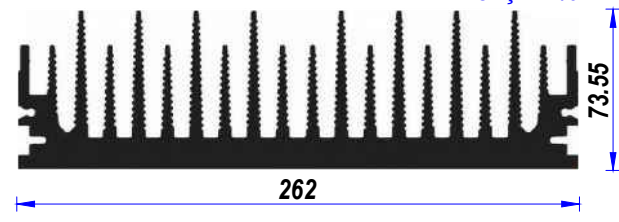

ÖLÇEK 1/3

YA-632

Alm.Sğt.Prf.

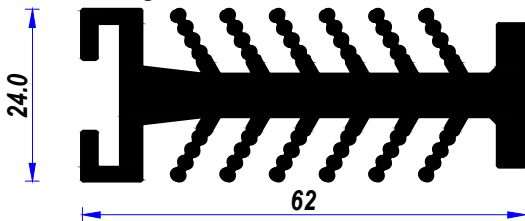

YA-633

Alm.Sğt.Prf.

ÖLÇEK 1/2

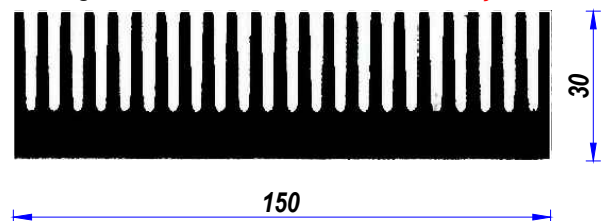

İSTENİLEN ÖLÇÜLERDE KESİM ve SİYAH ELOKSALLI KAPLAMA YAPILIR  
All cutting dimensions can be done according to requirements and Double black anodize

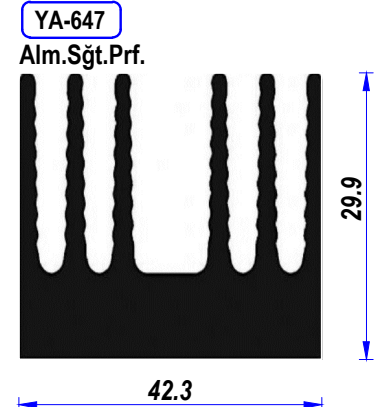
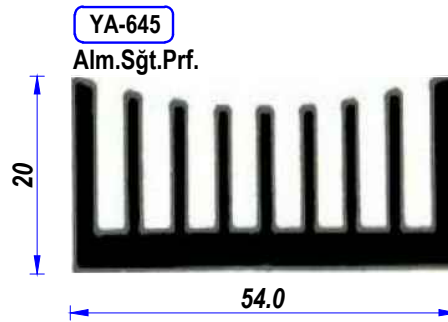
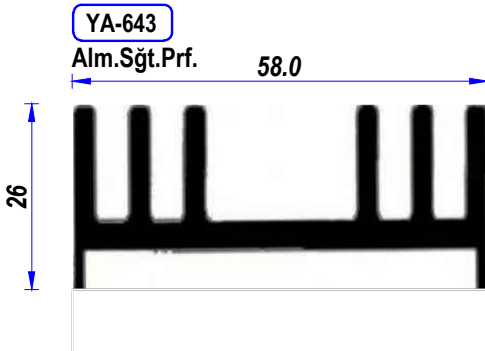
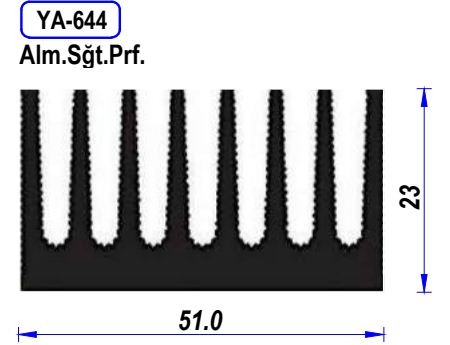
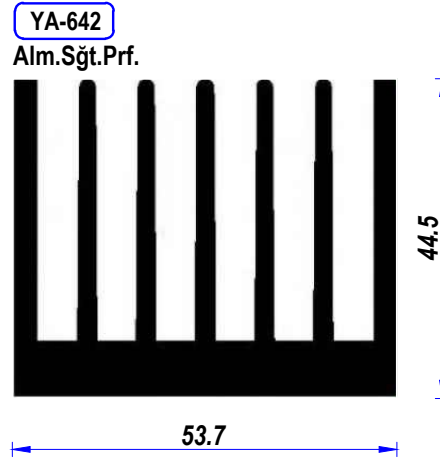
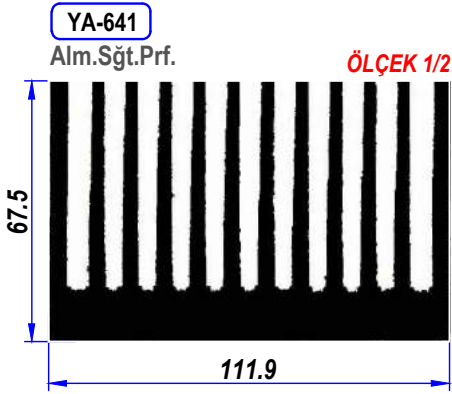
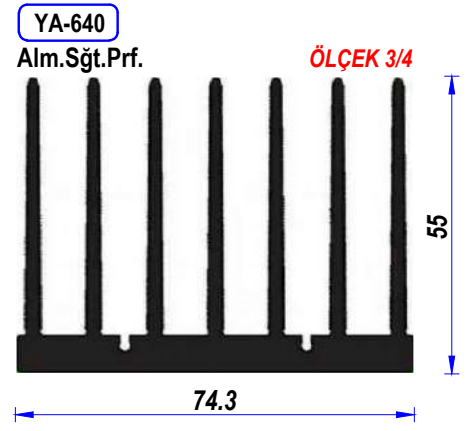
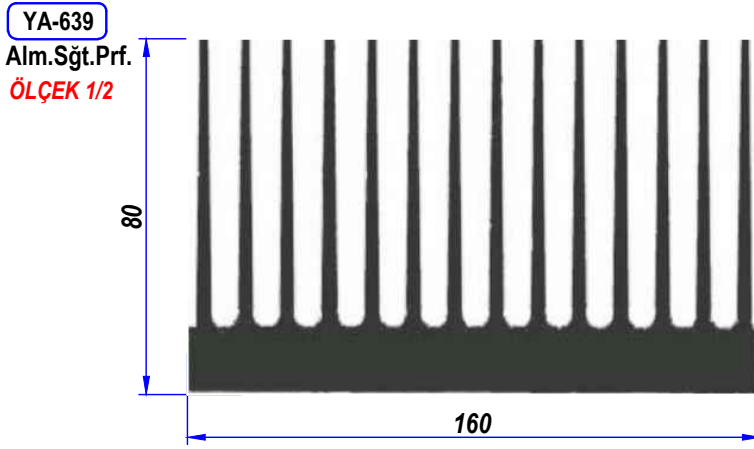
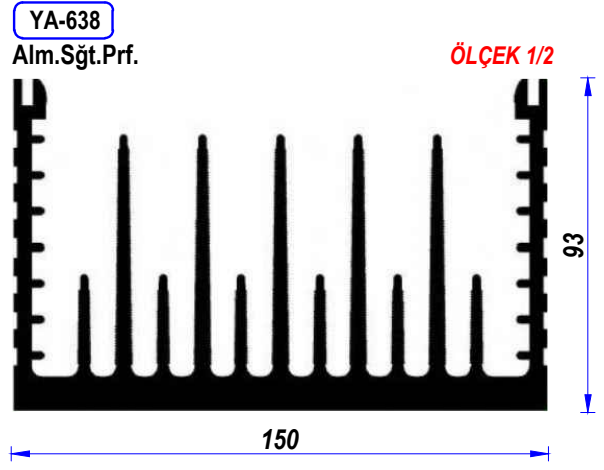
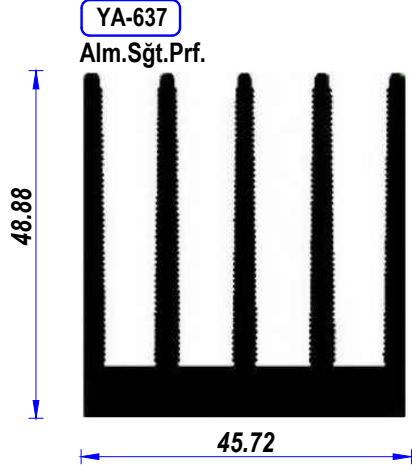

İSTENİLEN ÖLÇÜLERDE KESİM ve SİYAH ELOKSALLI KAPLAMA YAPILIR  
All cutting dimensions can be done according to requirements and Double black anodize

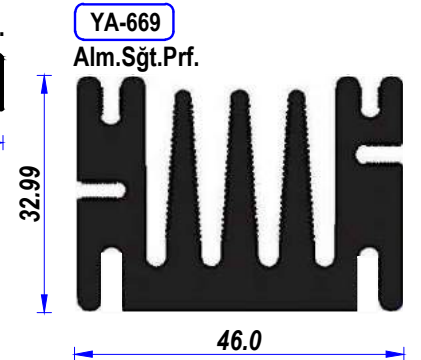
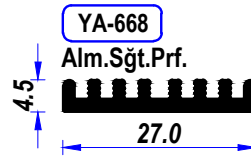
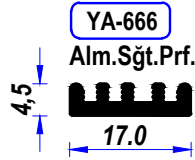
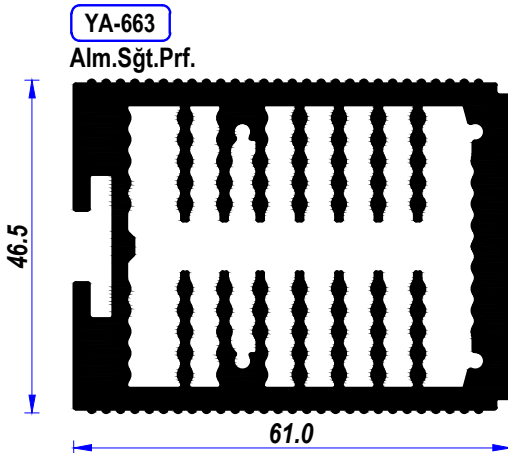
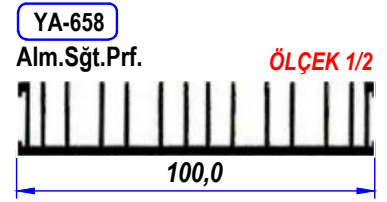
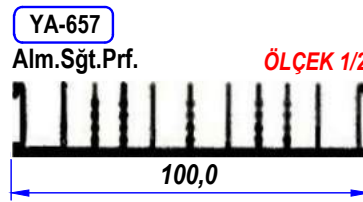
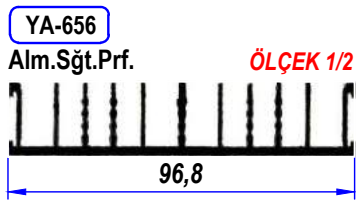
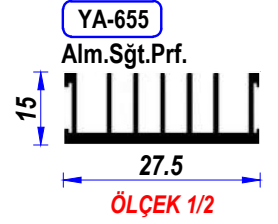
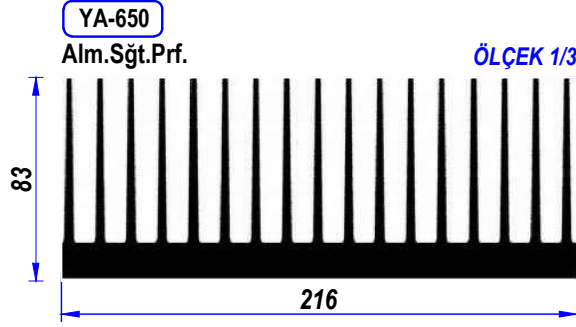
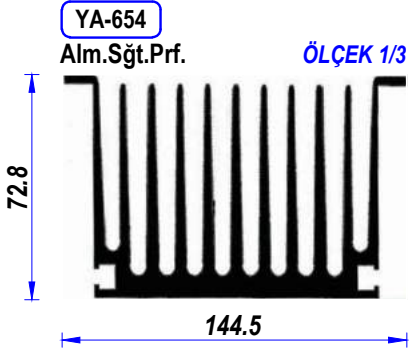
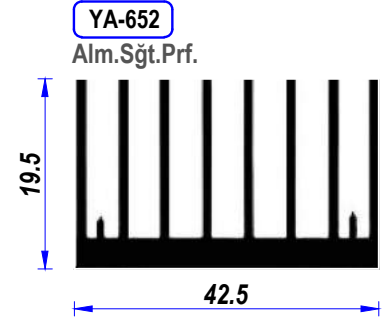
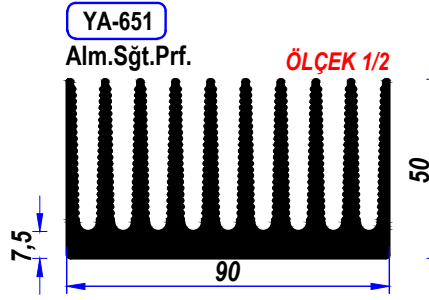
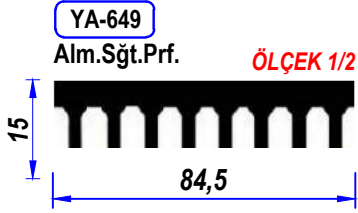
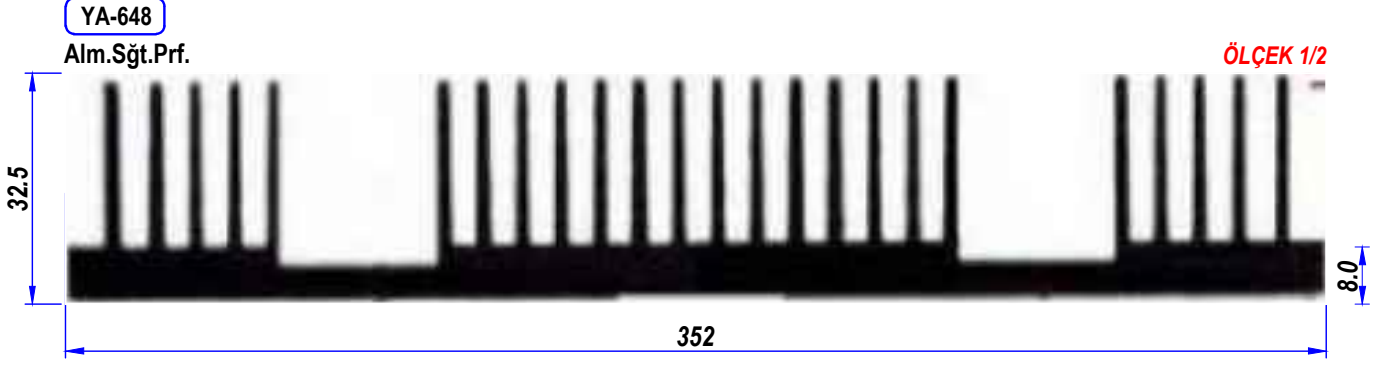

İSTENİLEN ÖLÇÜLERDE KESİM ve SİYAH ELOKSALLI KAPLAMA YAPILIR  
All cutting dimensions can be done according to requirements and Double black anodize

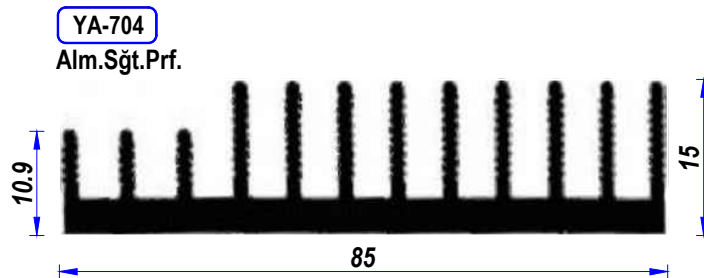
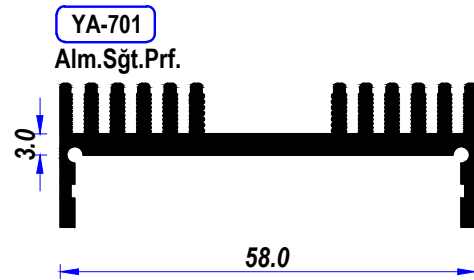
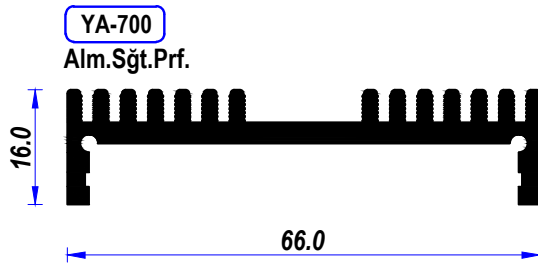
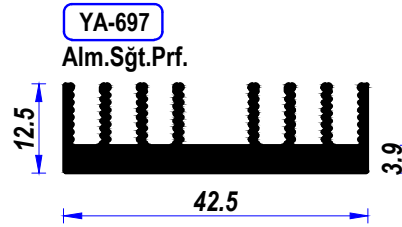
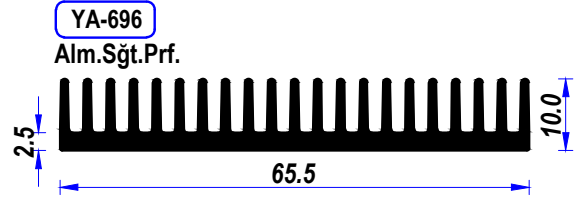
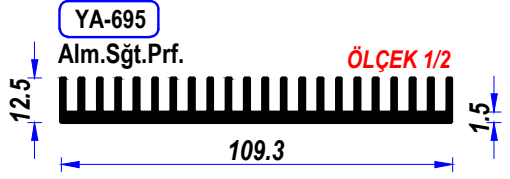
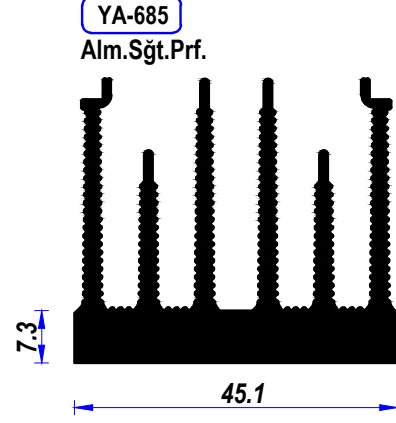
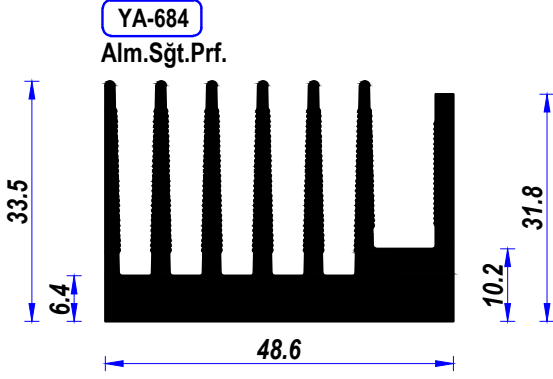
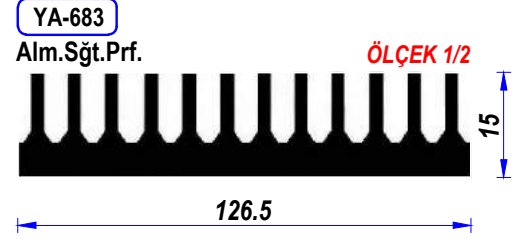
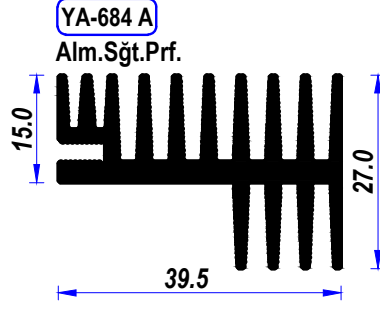
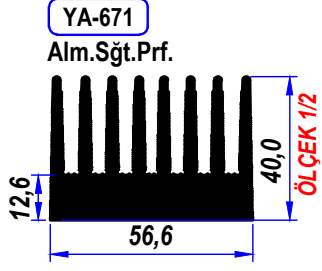

İSTENİLEN ÖLÇÜLERDE KESİM ve SİYAH ELOKSALLI KAPLAMA YAPILIR  
All cutting dimensions can be done according to requirements and Double black anodize

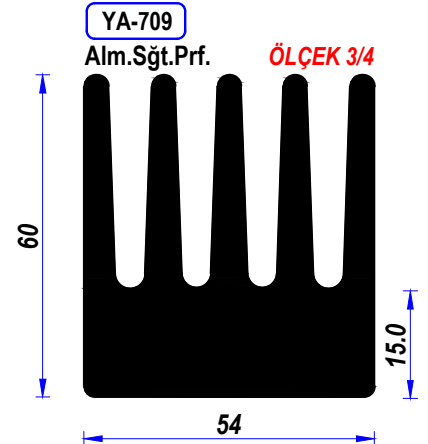
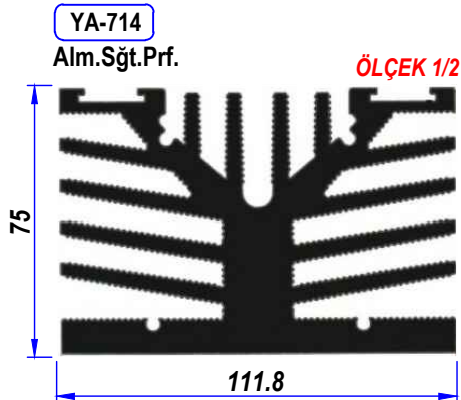
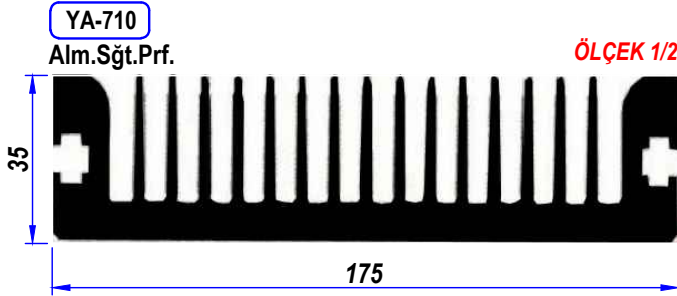
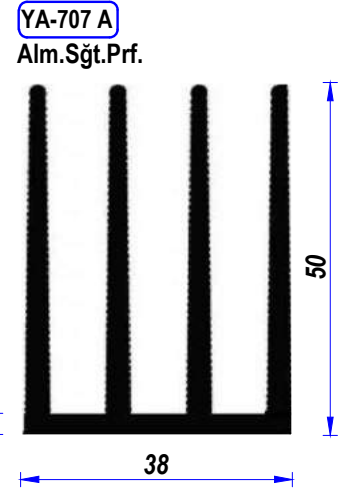
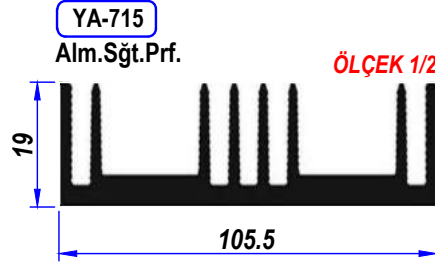
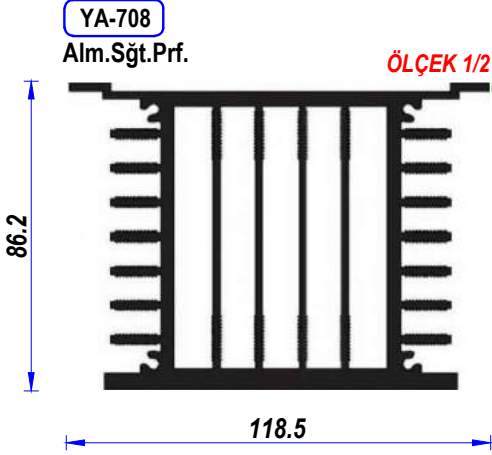
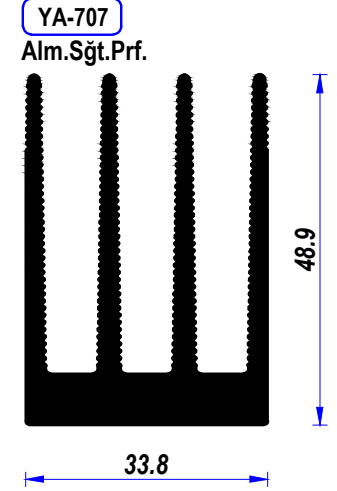
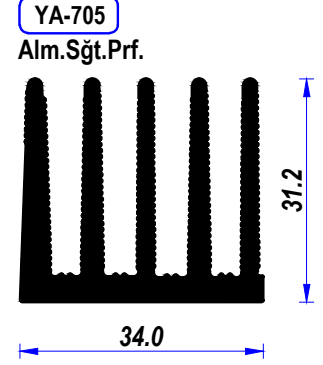
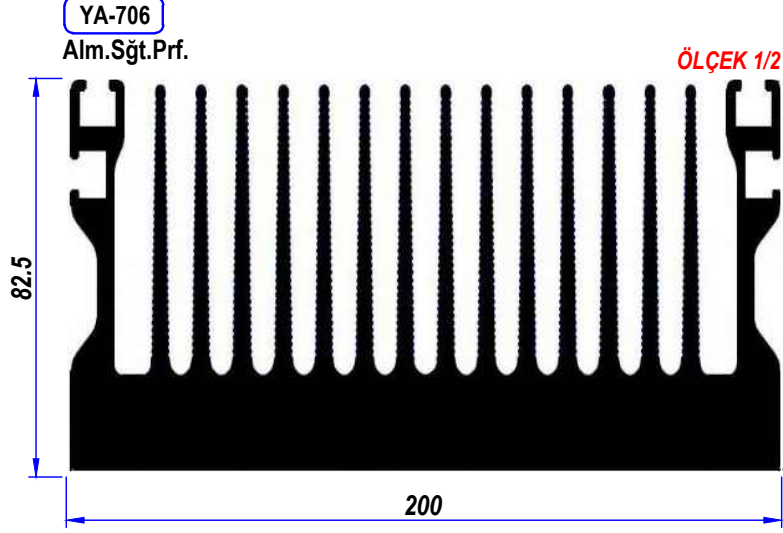

**İSTENİLEN ÖLÇÜLERDE KESİM ve SİYAH ELOKSALLI KAPLAMA YAPILIR**  
All cutting dimensions can be done according to requirements and Double black anodize

**Ledaks®**

**YENİLİKÇİ ÇÖZÜM ÜRETİR**

**Merkez : Koçak Caddesi no : 71 Siteler Altındağ Ankara**

**Tel : 0312 351 15 15 Fax : 0312 353 47 47**

**Web : [www.ledaks.com.tr](http://www.ledaks.com.tr) Mail : [info@ledaks.com](mailto:info@ledaks.com)**