

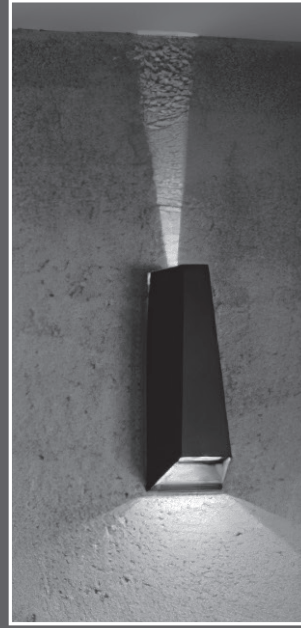

recta

a r t a n d l i g h t

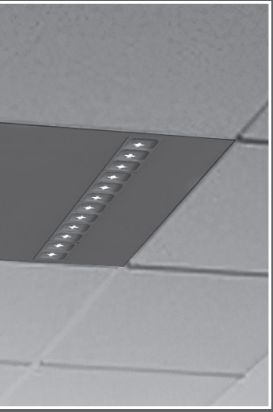

Price List 2023-2

Fiyat Listesi

www.rectalighting.com

 **recta**
art and light





Recta is the architectural lighting brand of Pelsan Lighting.

Pelsan gathers its 40 years of experience in the lighting industry under one roof with Recta in architectural lighting.

Special products for architectural lighting where elegance and aesthetics are at the forefront, architectural office luminaires, decorative luminaires, pendant luminaires, spot and track spots, indoor and outdoor wall lamps, garden luminaires, DMX, wallwasher and LED bar lighting, Recta provide solutions in one place.

Recta, Pelsan Aydınlatma'nın mimari aydınlatma markasıdır.

Pelsan 40 yıllık aydınlatma sektöründeki tecrübesini, mimari aydınlatmada Recta ile tek bir çatı altında topluyor.

Şıklığın ve estetiğin ön planda olduğu mimari aydınlatmalar için özel ürünler, mimari ofis armatürleri, dekoratif armatürler, sarkıt armatürler, spot ve ray spotlar, iç mekan ve dış mekan aplikler, bahçe armatürleri, DMX, wallwasher ve LED bar gibi aydınlatma çözümlerini Recta, sizler için tek bir adreste sunuyor.

 **recta**
a r t a n d l i g h t

OFFICE LUMINAIRES OFİS ARMATÜRLERİ

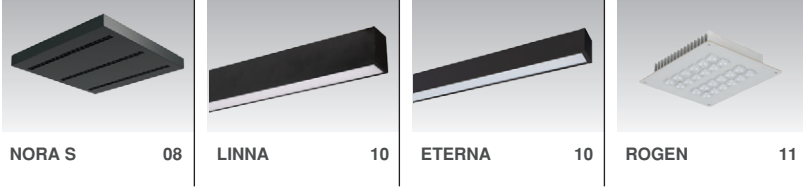

ARCHITECTURE - DECORATIVE LUMINAIRES MİMARİ - DEKORATİF ARMATÜR

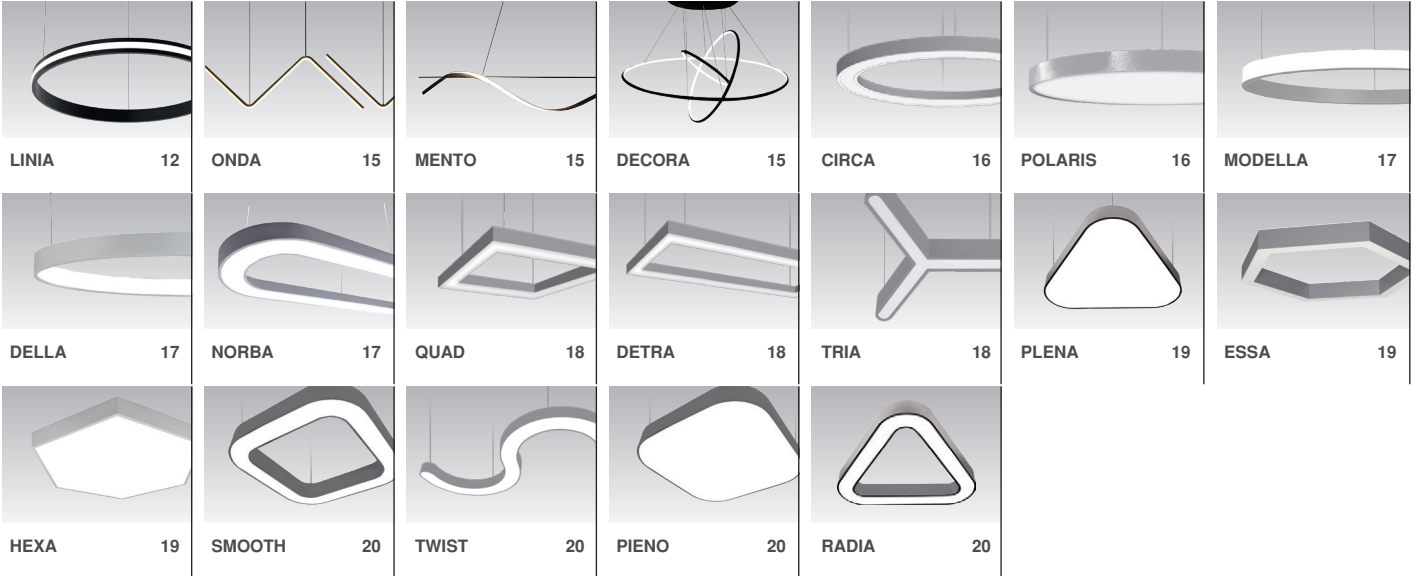

PENDANT LUMINAIRES SARKIT ARMATÜRLER

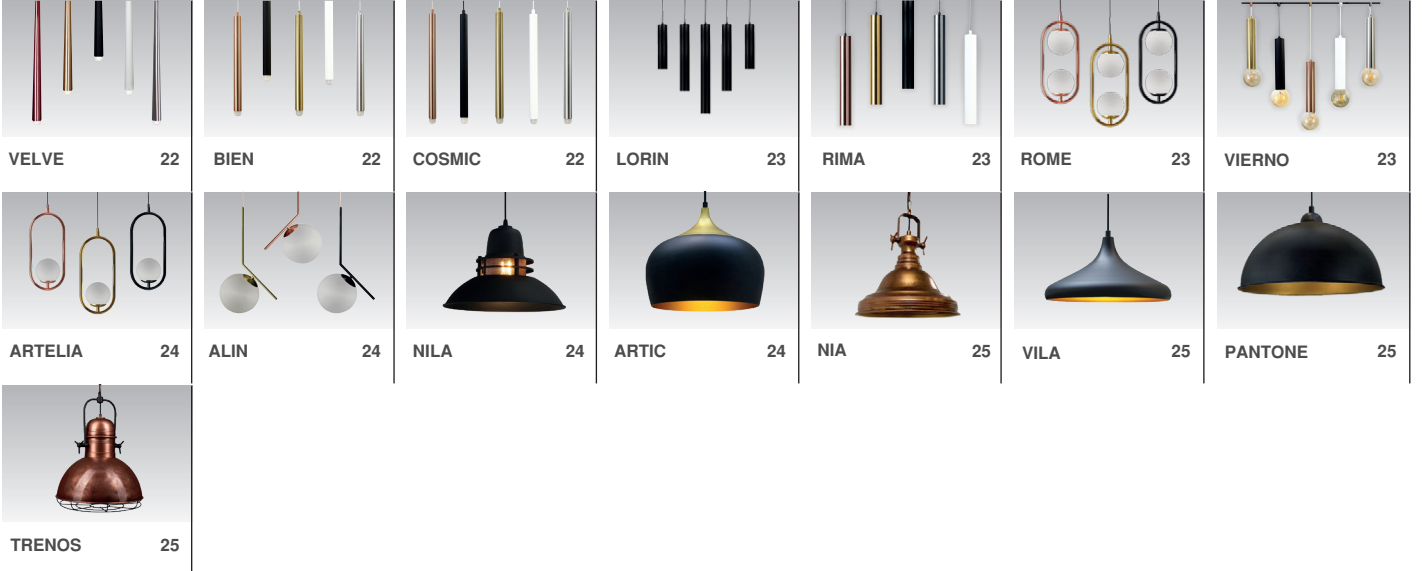







DOWNLIGHT, SPOT and TRACK SPOT LUMINAIRES

DOWNLIGHT, SPOT ve RAY SPOT ARMATÜRLER

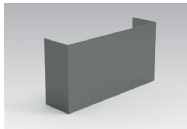
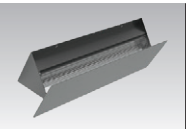
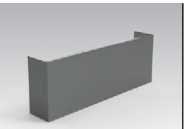
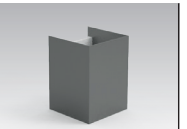
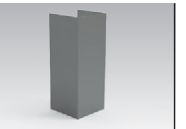
						
CAMIO 27	VIONE 27	TILLA 28	LISSO 29	BELLA 30	STELLA 30	LORA G2 33
						
BOE 35	SPICA G3 35	VIRA S2 35	NIRA G2 36	VEGA 37	TERRA 39	TALIA 41
						
THETA 45	ZETA G2 45	OMEGA G2 45	LAMEC 46	VIAR 46	CANVIO 47	NOBI 47

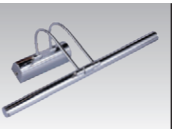
INDOOR APPLIQUES

İÇ MEKAN APLİKLER

						
LANDI 49	QUINN 49	DIAZ 49	LORCA UP/DOWN 50	RODIN 50	VOGEL 50	DA VINCI G2 51
						
MAYA 52	LORETA 52	PIA 52				

OUTDOOR APPLIQUES

DIŞ MEKAN APLİKLER



						
FERRA 53	TILVA 53	MOVA 53	CARLA 54	VASCO 54	SANTOS 54	DURA 54

GARDEN LUMINAIRES

BAHÇE ARMATÜRLERİ

					
APPLIQUES APLİKLER 56	BOLLARD BOLARDLAR 57	RECESSED FLOOR YER GÖMME 58	OSCALED 59	ESCALED 59	SANTA 59

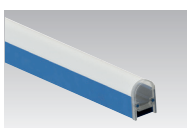
DMX - DMX WALLWASHER - LED BAR

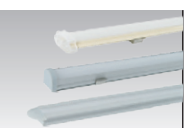
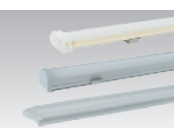
			
LINEAR DMX 61	DMX WALLWASHER 62	INDOOR İÇ MEKAN LED BAR 63	OUTDOOR DIŞ MEKAN LED BAR 64

 **recta**
a r t a n d l i g h t

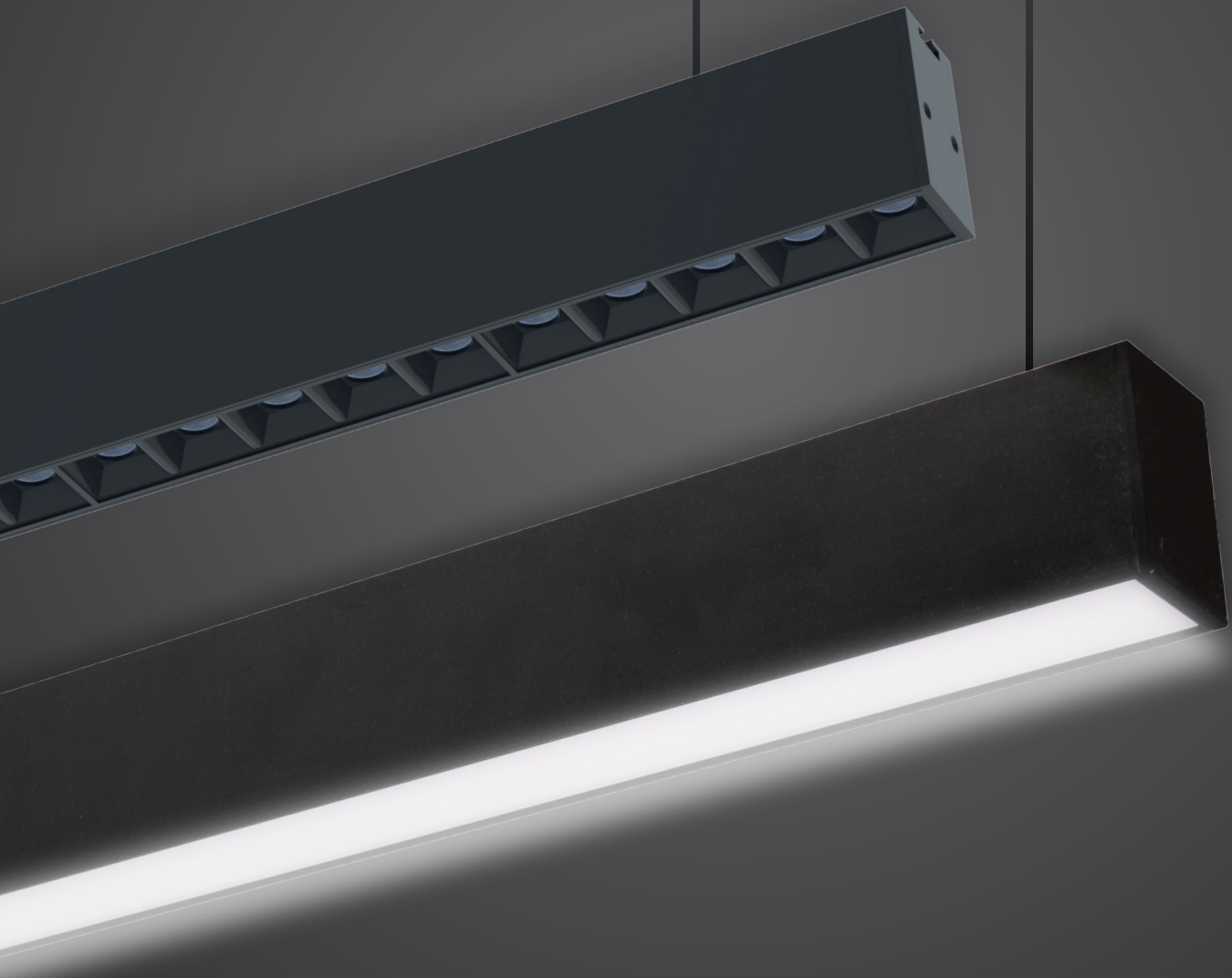

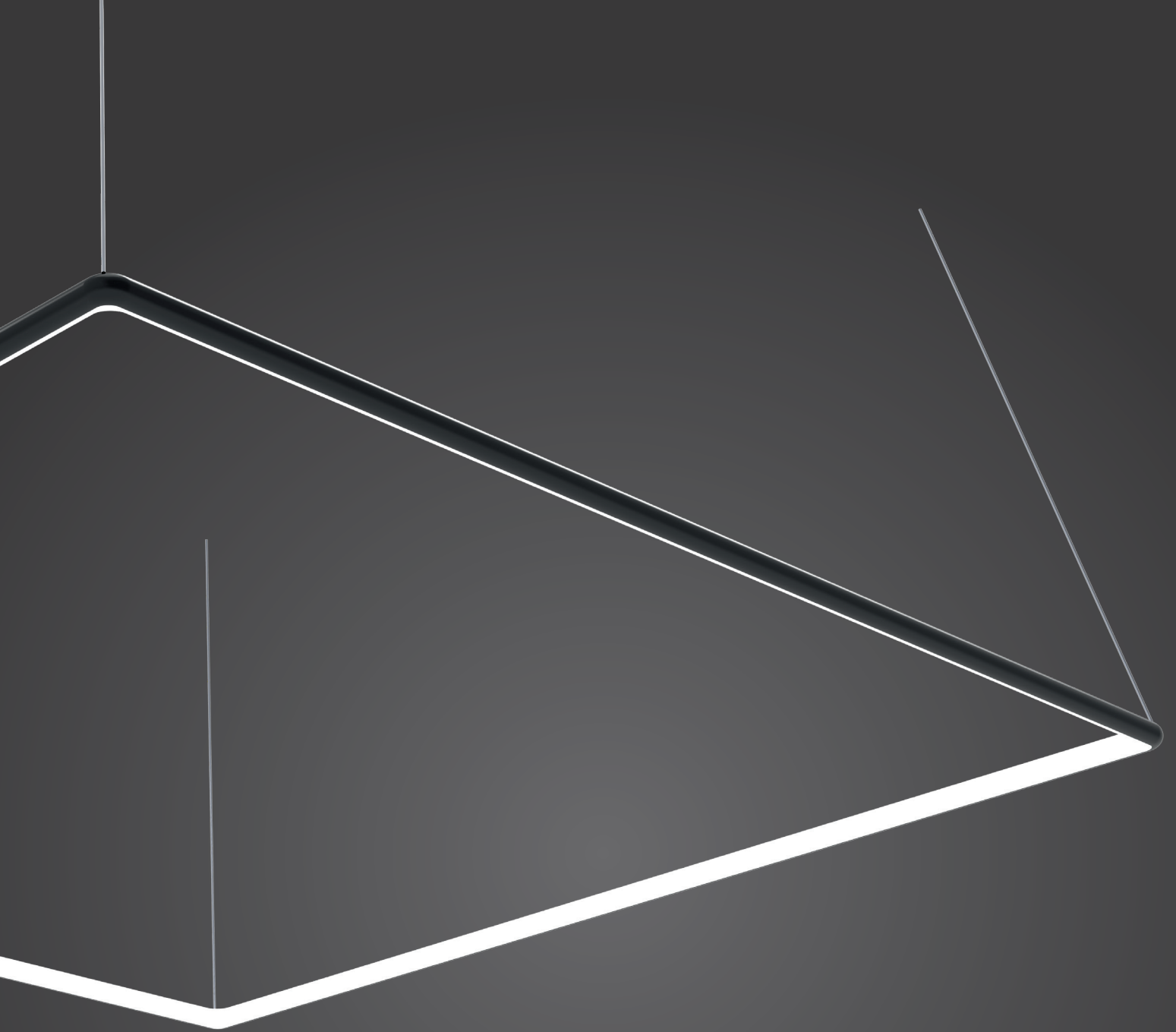

 **recta**
a r t a n d l i g h t

OFFICE LUMINAIRE
OFİS ARMATÜRLERİ

ARCHITECTURAL - DECORATIVE LUMINAIRES
MİMARİ - DEKORATİF ARMATÜRLER

★ 3 Different Mounting Option
3 Farklı Montaj Şekli

★ Anti-glare Optic Design
Kamaşma Önleyici Optik Tasarım

★ Up to 105lm/W Efficiency
105lm/W'a Varan Verimlilik

NORA S RECESSED MOUNTED NORA S SIVA ALTI

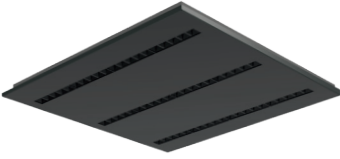

Code Kod	Power Güç (W)	Color Temp. Renk Sıcaklığı (K)	Luminous Flux Işık Akısı (lm)	Efficacy Etkinlik Faktörü (lm/W)	Dimensions Boyutlar (axbxc)	Cut Size Kesim Ölçüsü (mm)	Package Weight Koli Ağırlığı (kg)	Pcs/Pack Koli Adedi	Price Fiyat
209607	20	4000	2000	100	295x295x41	275x275	1,37	1	54,75\$
209608	30	4000	3000	100	575x295x41	575x275	2,5	1	83,80\$
209648	40	4000	4000	100	595x595x41	575x575	4,2	1	88,80\$
209609	60	4000	6000	100	595x595x41	575x575	4,2	1	108,60\$
209610	80	4000	8000	100	1195x295x41	1175x275	5,2	1	148,95\$

Aluminium Alüminyum PC Reflector PC Reflektör 3000/4000/6500K IP20 50.000h 2 years / yıl Plaster Ceiling Mounted Alçıpan Tavan
RAL 9005 RAL 9006 24° DALI 1-10V Emergency Unit (1-3 hour/saat)

NORA S SURFACE MOUNTED NORA S SIVA ÜSTÜ

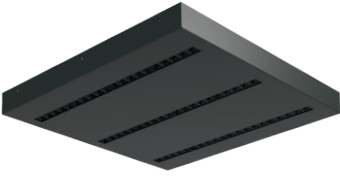

Code Kod	Power Güç (W)	Color Temp. Renk Sıcaklığı (K)	Luminous Flux Işık Akısı (lm)	Efficacy Etkinlik Faktörü (lm/W)	Dimensions Boyutlar (axbxc)	Package Weight Koli Ağırlığı (kg)	Pcs/Pack Koli Adedi	Price Fiyat
209612	20	4000	2100	105	295x295x35	1,68	1	56,25\$
209613	30	4000	3150	105	275x575x35	3	1	87,30\$
209649	40	4000	4200	105	595x595x35	5,09	1	92,30\$
209614	60	4000	6300	105	595x595x35	5,09	1	112,10\$
209615	80	4000	8400	105	1195x295x35	1	1	152,45\$

Aluminium Alüminyum PC Reflector PC Reflektör 3000/4000/6500K IP20 50.000h 2 years / yıl Plaster Ceiling Mounted Alçıpan Tavan
RAL 9005 RAL 9006 24° DALI 1-10V Emergency Unit (1-3 hour/saat)

NORA S LINEAR NORA S LINEER

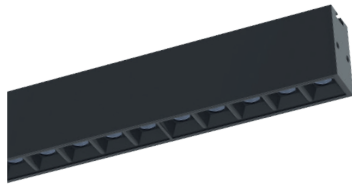

Code Kod	Power Güç (W)	Color Temp. Renk Sıcaklığı (K)	Luminous Flux Işık Akısı (lm)	Efficacy Etkinlik Faktörü (lm/W)	Dimensions Boyutlar (axbxc)	Package Weight Koli Ağırlığı (kg)	Pcs/Pack Koli Adedi	Price Fiyat
209630	6	4000	600	100	33x58x139	0,305	1	34,90\$
209631	12	4000	1200	100	33x58x271	1	1	44,40\$
209632	24	4000	2400	100	33x58x536	1	1	57,40\$
209633	36	4000	3600	100	33x58x801	1	1	78,90\$
209634	48	4000	4800	100	33x58x1066	1	1	113,30\$

Aluminium Alüminyum PC Reflector PC Reflektör 3000/4000/6500K IP20 50.000h 2 years / yıl
RAL 9005 RAL 9006 24° DALI 1-10V Emergency Unit (1-3 hour/saat)

NORA S LINEAR NORA S LINEER

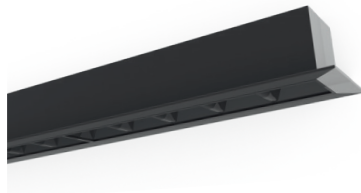

Code Kod	Power Güç (W)	Color Temp. Renk Sıcaklığı (K)	Luminous Flux Işık Akısı (lm)	Efficacy Etkinlik Faktörü (lm/W)	Dimensions Boyutlar (axbxc)	Cut Size Kesim Ölçüsü (mm)	Package Weight Koli Ağırlığı (kg)	Pcs/Pack Koli Adedi	Price Fiyat
209621	6	4000	600	100	50x80x153	43x138	-	1	31,40\$
209622	12	4000	1200	100	50x80x285	43x270	-	1	40,90\$
209623	24	4000	2400	100	50x80x550	43x535	-	1	53,90\$
209624	36	4000	3600	100	50x80x815	43x800	-	1	75,40\$
209625	48	4000	4800	100	50x80x1080	43x1065	-	1	109,80\$

Aluminium Alüminyum PC Reflector PC Reflektör 3000/4000/6500K IP20 50.000h 2 years / yıl
RAL 9005 RAL 9006 24° DALI 1-10V Emergency Unit (1-3 hour/saat)

* Provides perfect illumination with its modular structure
Modüler yapısıyla kusursuz aydınlatma sağlar



NORA S MODULER NORA S MODÜLE

Code Kod	Type Tip	Power Güç (W)	Color Temp. Renk Sıcaklığı (K)	Luminous Flux Işık Akısı (lm)	Efficacy Etkinlik Faktörü (lm/W)	Dimensions Boyutlar (axbxc)	Package Weight Koli Ağırlığı (kg)	Pcs/Pack Koli Adedi	Price Fiyat
209626	1 modul	3	4000	270	90	43x57x43	-	1	22,30\$
209627	2 modul	6	4000	540	90	43x57x73	-	1	28,60\$
209628	3 modul	9	4000	810	90	43x57x103	-	1	34,90\$
209629	4 modul	12	4000	1080	90	73x57x73	-	1	42,80\$

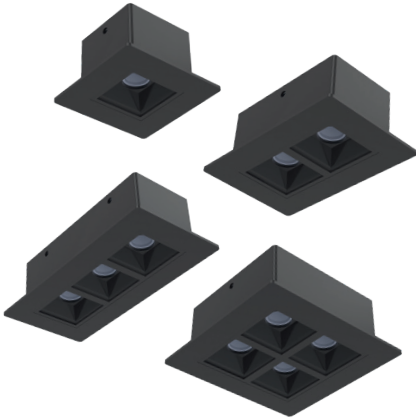

NORA S MODULER NORA S MODÜLE

Code Kod	Type Tip	Power Güç (W)	Color Temp. Renk Sıcaklığı (K)	Luminous Flux Işık Akısı (lm)	Efficacy Etkinlik Faktörü (lm/W)	Dimensions Boyutlar (axbxc)	Cut Size Kesim Ölçüsü (mm)	Package Weight Koli Ağırlığı (kg)	Pcs/Pack Koli Adedi	Price Fiyat
209617	1 modul	3	4000	270	90	54x80x54	43x43	0,15	1	18,80\$
209618	2 modul	6	4000	540	90	54x80x84	43x73	0,19	1	25,10\$
209619	3 modul	9	4000	810	90	54x80x114	43x103	0,24	1	31,40\$
209620	4 modul	12	4000	1080	90	84x80x84	76x76	0,32	1	39,25\$



NORA S

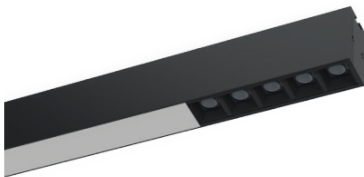

Code Kod	Power Güç (W)	Color Temp. Renk Sıcaklığı (K)	Luminous Flux Işık Akısı (lm)	Efficacy Etkinlik Faktörü (lm/W)	Dimensions Boyutlar (axbxc)	Package Weight Koli Ağırlığı (kg)	Pcs/Pack Koli Adedi	Price Fiyat
209635	39	4000	4100	105	33x58x1186	-	1	113,00\$
209636	47	4000	4935	105	33x58x1466	-	1	131,90\$
209637	58	4000	6090	105	33x58x1956	-	1	156,90\$
209638	72	4000	7560	105	33x58x2446	-	1	188,50\$





LINNA

Code Kod	Power Güç (W)	Color Temp. Renk Sıcaklığı (K)	Luminous Flux Işık Akısı (lm)	Efficacy Etkinlik Faktörü (lm/W)	Dimensions Boyutlar (axbxc)	Package Weight Koli Ağırlığı (kg)	Pcs/Pack Koli Adedi	Price Fiyat
209137	20	4000	2000	100	50x70x500	-	1	30,60\$
209139	36	4000	3600	100	50x70x1000	-	1	61,20\$
209140	45	4000	4500	100	50x70x1500	-	1	91,80\$

Aluminium Alüminyum	Opal Diffuser Opal Difüzör	3000/4000/6500K	IP40	50.000h	2 years / yıl
RAL 9005	RAL 9006	RAL 9016	160°	DALI	1-10V
Emergency Unit (1-3 hour/saat)					

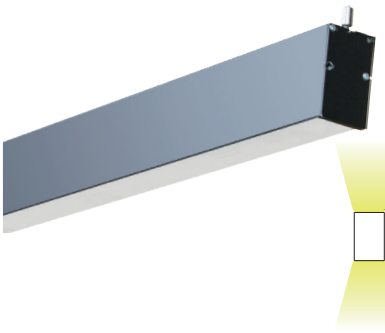

ETERNA DIRECT & ENDIRECT ETERNA DİREKT & ENDİREKT

Code Kod	Power Güç (W)	Color Temp. Renk Sıcaklığı (K)	Luminous Flux Işık Akısı (lm)	Efficacy Etkinlik Faktörü (lm/W)	Dimensions Boyutlar (axbxc)	Package Weight Koli Ağırlığı (kg)	Pcs/Pack Koli Adedi	Price Fiyat
206015	26-16	4000	2600-1440	100-90	47x900x85	-	1	124,00\$
206016	34-18	4000	3400-1620	100-90	47x1200x85	-	1	137,20\$
206017	44-24	4000	4400-2160	100-90	47x1470x85	-	1	163,00\$
206018	60-40	4000	6000-3600	100-90	47x2000x85	-	1	229,10\$

Aluminium Alüminyum	Opal Diffuser Opal Difüzör	3000/4000/6500K	IP40	50.000h	2 years / yıl
160°	DALI	Emergency Unit (1-3 hour/saat)			

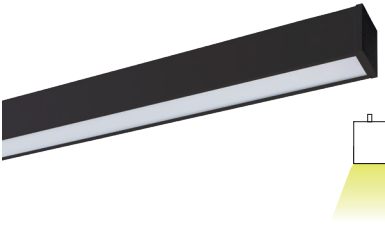

TRENTA G2

Code Kod	Power Güç (W)	Color Temp. Renk Sıcaklığı (K)	Luminous Flux Işık Akısı (lm)	Efficacy Etkinlik Faktörü (lm/W)	Dimensions Boyutlar (axbxc)	Package Weight Koli Ağırlığı (kg)	Pcs/Pack Koli Adedi	Price Fiyat
113031	36	4000	3060	85	1020x33x60	12	12	40,30\$
113029	36	6500	3060	85	1020x33x60	12	12	40,30\$

Aluminium Alüminyum	Opal Diffuser Opal Difüzör	3000/4000/6500K	IP40	36.000h	2 years / yıl
120°	Emergency Unit (1-3 hour/saat)				



ETERNA

Code Kod	Power Güç (W)	Color Temp. Renk Sıcaklığı (K)	Luminous Flux Işık Akısı (lm)	Efficacy Etkinlik Faktörü (lm/W)	Dimensions Boyutlar (axbxc)	Cut Size Kesim Ölçüsü (mm)	Package Weight Koli Ağırlığı (kg)	Pcs/Pack Koli Adedi	Price Fiyat
108898	14	4000	1260	90	625x77x85	620x62	1,15	1	44,40\$
108899	20	4000	1800	90	895x77x85	900x62	1,47	1	58,70\$
108900	28	4000	2520	90	1225x77x85	1220x62	1,77	1	71,40\$
108901	42	4000	3780	90	1505x77x85	1500x62	2,15	1	95,50\$

Aluminium Alüminyum	Opal Diffuser Opal Difüzör	3000/4000/6500K	IP40	50.000h	2 years / yıl
160°	DALI	1-10V	Emergency Unit (1-3 hour/saat)		

Code Kod	Features Özellikler	Pcs/Pack Koli Adedi	Price Fiyat
304906	Hanger Set / Askı Takımı 1m (2adet/pcs)	1	4,60\$
304915	Hanger Set / Askı Takımı 1,5m (2adet/pcs)	1	5,60\$

Code Kod	Features Özellikler	Pcs/Pack Koli Adedi	Price Fiyat
317986	Hanger Rozans Set / Askı Rozans Takımı 1,5cm (2adet/pcs)	1	5,60\$
205224	Linear joining apparatus set / Lineer Birleştirme Aparat Takımı 1	1	2,30\$

ROGEN

- * IP40 Aluminium Body
IP40 Alüminyum Gövde
- * PMMA Lens
10°/30°/45° Beam Angle
10°/30°/45° Lens Açısı
- * Up to 142lm/W Efficacy
142 lm/W'a Varan verimlilik

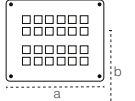

ROGEN

Code Kod	Power Güç (W)	Color Temp. Renk Sıcaklığı (K)	Luminous Flux Işık Akısı (lm)	Efficacy Etkinlik Faktörü (lm/W)	Dimensions Boyutlar (axbxc)	Package Weight Koli Ağırlığı (kg)	Pcs/Pack Koli Adedi	Price Fiyat
208665	12	4000	1704	142	112x212	1,24	1	46,10\$
208666	24	4000	3408	142	178x212	1,6	1	81,55\$
208667	36	4000	5112	142	244x212	2	1	110,90\$
208668	48	4000	6818	142	330x212	2,4	1	147,90\$

- Aluminium Alüminyum
- PMMA
- 4000/6500K
- IP40
- 50.000h
- 2 years / yıl
- 10°/30°/45°
- DALI
- 1-10V





LINIA-C

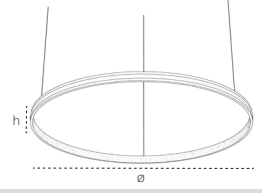

Code Kod	Power Güç (W)	Color Temp. Renk Sıcaklığı (K)	Luminous Flux Işık Akısı (lm)	Efficacy Etkinlik Faktörü (lm/W)	Dimensions Boyutlar (øxh)	Package Weight Koli Ağırlığı (kg)	Pcs/Pack Koli Adedi	Price Fiyat
208228	19	4000	1520	80	300x35	2,21	1	90,40\$
208229	32	4000	2560	80	500x35	2,45	1	105,30\$
208230	44	4000	3520	80	700x35	2,64	1	119,90\$
208420	57	4000	4560	80	900x35	2,86	1	135,10\$
208231	19	6500	1520	80	300x35	2,21	1	90,40\$
208232	32	6500	2560	80	500x35	2,45	1	105,30\$
208233	44	6500	3520	80	700x35	2,64	1	119,90\$
208421	57	6500	4560	80	900x35	2,86	1	135,10\$

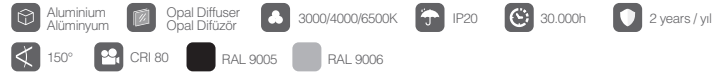

Suspension set is included to the price.
Aski aparatı fiyata dahildir.



LINIA-R

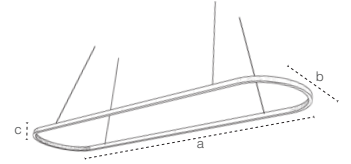

Code Kod	Power Güç (W)	Color Temp. Renk Sıcaklığı (K)	Luminous Flux Işık Akısı (lm)	Efficacy Etkinlik Faktörü (lm/W)	Dimensions Boyutlar (axbxc)	Package Weight Koli Ağırlığı (kg)	Pcs/Pack Koli Adedi	Price Fiyat
208302	56	4000	4480	80	900x300x17	2,28	1	176,90\$
208303	60	4000	4800	80	1100x300x17	2,43	1	193,10\$
208304	68	4000	5440	80	1400x300x17	2,98	1	208,70\$
208305	80	4000	6400	80	1700x300x17	3,35	1	225,10\$
208308	56	6500	4480	80	900x300x17	2,28	1	193,10\$
208307	60	6500	4800	80	1100x300x17	2,43	1	176,90\$
208309	68	6500	5440	80	1400x300x17	2,98	1	208,70\$
208310	80	6500	6400	80	1700x300x17	3,35	1	225,10\$

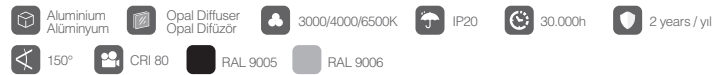

Suspension set is included to the price.
Aski aparatı fiyata dahildir.



LINIA-S

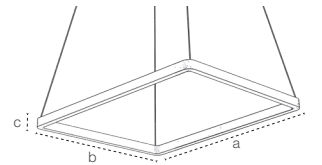

Code Kod	Power Güç (W)	Color Temp. Renk Sıcaklığı (K)	Luminous Flux Işık Akısı (lm)	Efficacy Etkinlik Faktörü (lm/W)	Dimensions Boyutlar (axbxc)	Package Weight Koli Ağırlığı (kg)	Pcs/Pack Koli Adedi	Price Fiyat
208250	40	4000	3200	80	700x300x17	1,98	1	138,00\$
208251	48	4000	3840	80	900x300x17	2,27	1	144,10\$
208252	56	4000	4480	80	1100x300x17	2,45	1	150,10\$
208254	40	6500	3200	80	700x300x17	1,98	1	138,00\$
208255	48	6500	3840	80	900x300x17	2,27	1	144,10\$
208256	56	6500	4480	80	1100x300x17	2,45	1	150,10\$



Suspension set is included to the price.
Aski aparatı fiyata dahildir.

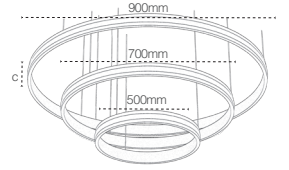

LINIA-C TRIPLE

Code Kod	Power Güç (W)	Color Temp. Renk Sıcaklığı (K)	Luminous Flux Işık Akısı (lm)	Efficacy Etkinlik Faktörü (lm/W)	Dimensions Boyutlar (ç)	Package Weight Koli Ağırlığı (kg)	Pcs/Pack Koli Adedi	Price Fiyat
208426	132	4000	10560	80	35	4,32	1	319,90\$
208427	132	6500	10560	80	35	4,32	1	319,90\$

Aluminium Alüminyum	Opal Diffuser Opal Difüzör	3000/4000/6500K	IP20	30.000h	2 years / yıl
150°	CRI 80	RAL 9005	RAL 9006		

Suspension set is included to the price.
Askı aparatı fiyata dahildir.

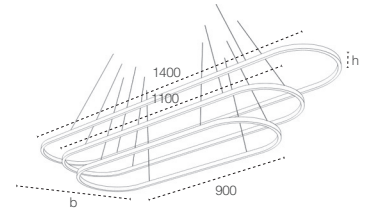

LINIA-R TRIPLE

Code Kod	Power Güç (W)	Color Temp. Renk Sıcaklığı (K)	Luminous Flux Işık Akısı (lm)	Efficacy Etkinlik Faktörü (lm/W)	Dimensions Boyutlar (b x h)	Package Weight Koli Ağırlığı (kg)	Pcs/Pack Koli Adedi	Price Fiyat
208306	154	4000	12320	80	300x17	2,32	1	449,50\$
208311	154	6500	12320	80	300x17	2,32	1	449,50\$

Aluminium Alüminyum	Opal Diffuser Opal Difüzör	3000/4000/6500K	IP20	30.000h	2 years / yıl
150°	CRI 80	RAL 9005	RAL 9006		

Suspension set is included to the price.
Askı aparatı fiyata dahildir.

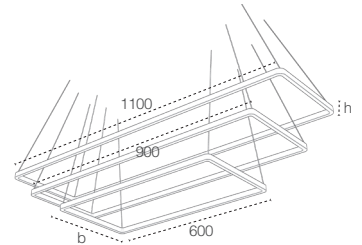
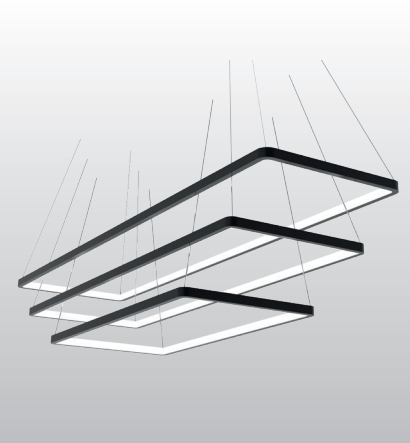

LINIA-S TRIPLE

Code Kod	Power Güç (W)	Color Temp. Renk Sıcaklığı (K)	Luminous Flux Işık Akısı (lm)	Efficacy Etkinlik Faktörü (lm/W)	Dimensions Boyutlar (b x h)	Package Weight Koli Ağırlığı (kg)	Pcs/Pack Koli Adedi	Price Fiyat
208253	140	4000	11200	80	300x17	4,25	1	319,90\$
208257	140	6500	11200	80	300x17	4,25	1	319,90\$

Aluminium Alüminyum	Opal Diffuser Opal Difüzör	3000/4000/6500K	IP20	30.000h	2 years / yıl
150°	CRI 80	RAL 9005	RAL 9006		

Suspension set is included to the price.
Askı aparatı fiyata dahildir.



LİNİA-D

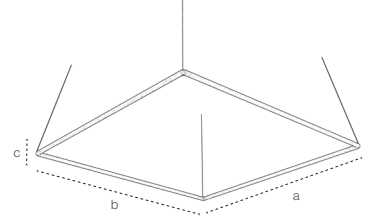

Code Kod	Power Güç (W)	Color Temp. Renk Sıcaklığı (K)	Luminous Flux Işık Akısı (lm)	Efficacy Etkinlik Faktörü (lm/W)	Dimensions Boyutlar (axbxc)	Package Weight Koli Ağırlığı (kg)	Pcs/Pack Koli Adedi	Price Fiyat
208316	192	4000	15360	80	900x900x16	6,29	1	418,10\$
208317	192	6500	15360	80	900x900x16	6,29	1	418,10\$

Aluminium Alüminyum	Opal Diffuser Opal Difüzör	3000/4000/6500K	IP20	30.000h	2 years / yıl
150°	CRI 80	RAL 9005	RAL 9006		

Suspension set is included to the price.
Askı aparatı fiyata dahildir.

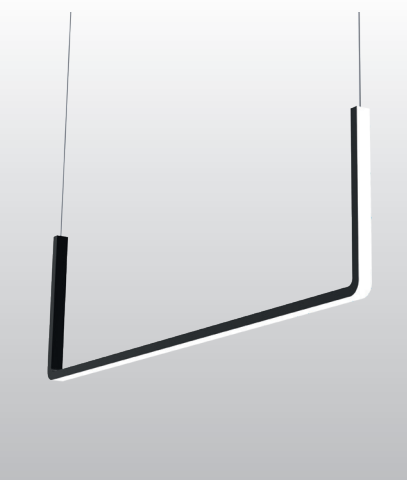

LİNİA-U

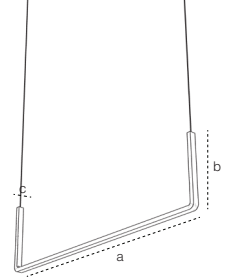

Code Kod	Power Güç (W)	Color Temp. Renk Sıcaklığı (K)	Luminous Flux Işık Akısı (lm)	Efficacy Etkinlik Faktörü (lm/W)	Dimensions Boyutlar (axbxc)	Package Weight Koli Ağırlığı (kg)	Pcs/Pack Koli Adedi	Price Fiyat
208274	18	4000	1440	80	500x200x17	1,38	1	56,30\$
208275	22	4000	1760	80	700x200x17	1,56	1	61,90\$
208276	26	4000	2080	80	900x200x17	1,74	1	67,70\$
208277	32	4000	2560	80	1200x200x17	1,96	1	73,40\$
208278	18	6500	1440	80	500x200x17	1,38	1	56,30\$
208279	22	6500	1760	80	700x200x17	1,56	1	61,90\$
208280	26	6500	2080	80	900x200x17	1,74	1	67,70\$
208281	32	6500	2560	80	1200x200x17	1,96	1	73,40\$

Aluminium Alüminyum	Opal Diffuser Opal Difüzör	3000/4000/6500K	IP20	30.000h	2 years / yıl
150°	CRI 80	RAL 9005	RAL 9006		

Suspension set is included to the price.
Askı aparatı fiyata dahildir.

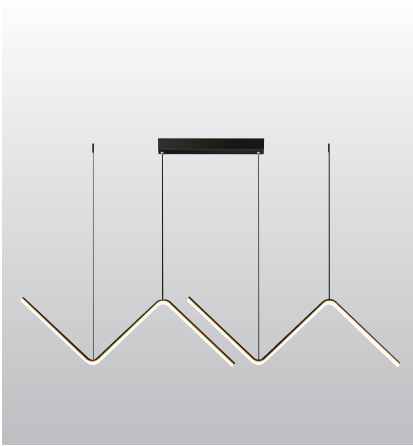

ONDA

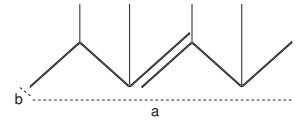

Code Kod	Power Güç (W)	Color Temp. Renk Sıcaklığı (K)	Luminous Flux Işık Akısı (lm)	Efficacy Etkinlik Faktörü (lm/W)	Dimensions Boyutlar (axb)	Package Weight Koli Ağırlığı (kg)	Pcs/Pack Koli Adedi	Price Fiyat
206338	27	4000	2160	80	1200x20	1,61	1	89,80\$
206339	27	6500	2160	80	1200x20	1,61	1	89,80\$

Aluminium Alüminyum	Opal Diffuser Opal Difüzör	3000/4000/6500K	IP20	50.000h	2 years / yil
150°	CRI 80	RAL 9005	RAL 9006		



MENTO

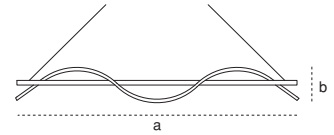

Code Kod	Power Güç (W)	Color Temp. Renk Sıcaklığı (K)	Luminous Flux Işık Akısı (lm)	Efficacy Etkinlik Faktörü (lm/W)	Dimensions Boyutlar (axbx)	Package Weight Koli Ağırlığı (kg)	Pcs/Pack Koli Adedi	Price Fiyat
206350	23	4000	1840	80	1200x300x300	2,4	1	94,40\$
206351	23	6500	1840	80	1200x300x300	2,4	1	94,40\$

Aluminium Alüminyum	Opal Diffuser Opal Difüzör	3000/4000/6500K	IP20	50.000h	2 years / yil
150°	CRI 80	RAL 9005	RAL 9006		

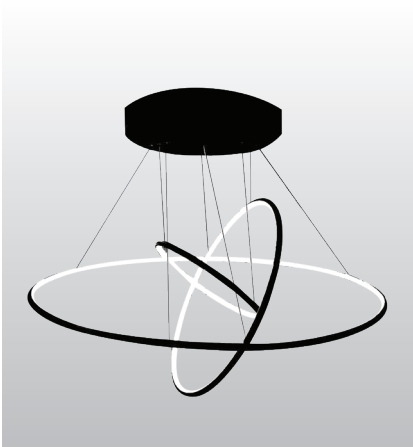

DECORA

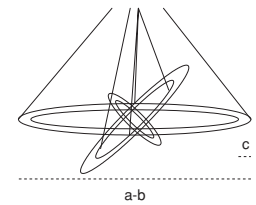

Code Kod	Power Güç (W)	Color Temp. Renk Sıcaklığı (K)	Luminous Flux Işık Akısı (lm)	Efficacy Etkinlik Faktörü (lm/W)	Dimensions Boyutlar (axbxc)	Package Weight Koli Ağırlığı (kg)	Pcs/Pack Koli Adedi	Price Fiyat
206344	75	4000	6750	90	750x750x100	5,2	1	237,80\$
206345	75	6500	6750	90	750x750x100	5,2	1	237,80\$

Aluminium Alüminyum	Opal Diffuser Opal Difüzör	3000/4000/6500K	IP20	50.000h	2 years / yil
150°	CRI 80	RAL 9005	RAL 9006		

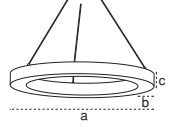

CIRCA

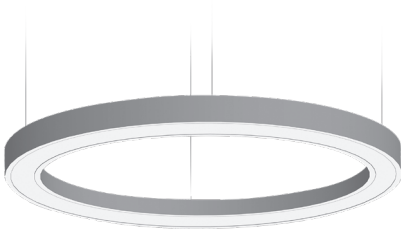

Code Kod	Power Güç (W)	Color Temp. Renk Sıcaklığı (K)	Luminous Flux Işık Akısı (lm)	Efficacy Etkinlik Faktörü (lm/W)	Dimensions Boyutlar (a x b x c)	Package Weight Koli Ağırlığı (kg)	Pcs/Pack Koli Adedi	Price Fiyat
110125	32	4000	3520	110	400x80x80	3	1	90,80\$
110126	50	4000	5500	110	600x80x80	4,5	1	121,70\$
110127	75	4000	8625	115	900x80x80	8	1	197,20\$
110128	100	4000	11500	115	1200x80x80	11	1	254,60\$
110237	32	6500	3520	110	400x80x80	3	1	90,80\$
110241	50	6500	5500	110	600x80x80	4,5	1	121,70\$
110244	75	6500	8625	115	900x80x80	8	1	197,20\$
110247	100	6500	11500	115	1200x80x80	11	1	254,60\$

Aluminium Alüminyum	Opal Diffuser Opal Difüzör	3000/4000/6500K	IP40	50.000h	2 years / yıl		
150°	CRI 80	DALI	1-10V	Emergency Unit	RAL 9005	RAL 9006	RAL 9016

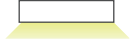

CIRCA DIRECT & INDIRECT CIRCA DİREKT & ENDİREKT

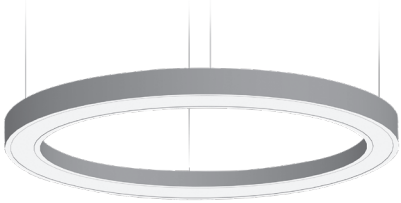
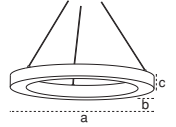

Code Kod	Power Güç (W)	Color Temp. Renk Sıcaklığı (K)	Luminous Flux Işık Akısı (lm)	Efficacy Etkinlik Faktörü (lm/W)	Dimensions Boyutlar (a x b x c)	Package Weight Koli Ağırlığı (kg)	Pcs/Pack Koli Adedi	Price Fiyat
206054	47	4000	5170	110	400x80x80	3,5	1	139,50\$
206055	75	4000	8250	110	600x80x80	4,8	1	177,00\$
206056	110	4000	12650	115	900x80x80	8,5	1	263,00\$
206057	165	4000	18150	110	1200x80x80	12	1	325,30\$
206058	190	4000	20900	110	1500x80x80	13	1	439,30\$
208436	47	6500	5170	110	400x80x80	3,5	1	139,50\$
208435	75	6500	8250	110	600x80x80	4,8	1	177,00\$
208434	110	6500	12650	115	900x80x80	8,5	1	263,00\$
208433	165	6500	18150	110	1200x80x80	12	1	325,30\$
208432	190	6500	20900	110	1500x80x80	13	1	439,30\$

Aluminium Alüminyum	Opal Diffuser Opal Difüzör	3000/4000/6500K	IP40	50.000h	2 years / yıl		
150°	CRI 80	DALI	1-10V	Emergency Unit	RAL 9005	RAL 9006	RAL 9016



POLARIS

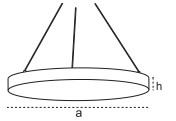

Code Kod	Power Güç (W)	Color Temp. Renk Sıcaklığı (K)	Luminous Flux Işık Akısı (lm)	Efficacy Etkinlik Faktörü (lm/W)	Dimensions Boyutlar (Ø x h)	Package Weight Koli Ağırlığı (kg)	Pcs/Pack Koli Adedi	Price Fiyat
110129	36	4000	4140	115	400x80	3	1	93,10\$
110130	50	4000	5750	115	600x80	4,5	1	145,40\$
110131	100	4000	11500	115	900x80	7	1	241,30\$
110250	36	6500	4140	115	400x80	3	1	93,10\$
110252	50	6500	5750	115	600x80	4,5	1	145,40\$
110255	100	6500	11500	115	900x80	7	1	241,30\$

Aluminium Alüminyum	Opal Diffuser Opal Difüzör	3000/4000/6500K	IP40	50.000h	2 years / yıl		
150°	CRI 80	DALI	1-10V	Emergency Unit	RAL 9005	RAL 9006	RAL 9016

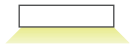

Code Kod	Features Özellikler	Pcs/Pack Koli Adedi	Price Fiyat
321505	4lü Hanger Set / Askı Takımı 1,5m RAL9005	1	14,40\$
321504	4lü Hanger Set / Askı Takımı 5m RAL9005	1	20,20\$
	For DALI / DALI Farklı	1	31,25\$

Code Kod	Features Özellikler	Pcs/Pack Koli Adedi	Price Fiyat
321177	4lü Hanger Set / Askı Takımı 1,5m RAL9006	1	14,40\$
321176	4lü Hanger Set / Askı Takımı 5m RAL9006	1	20,20\$



MODELLA

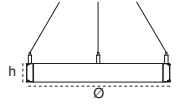

Code Kod	Power Güç (W)	Color Temp. Renk Sıcaklığı (K)	Luminous Flux Işık Akısı (lm)	Efficacy Etkinlik Faktörü (lm/W)	Dimensions Boyutlar (Øxh)	Package Weight Koli Ağırlığı (kg)	Pcs/Pack Koli Adedi	Price Fiyat
206405	20	4000	2000	100	410x50	2,1	1	155,60\$
206411	30	4000	3000	100	610x50	3,2	1	201,50\$
206417	46	4000	4600	100	910x50	4,8	1	263,00\$
206423	60	4000	6000	100	1210x50	7,5	1	356,60\$
206403	20	6500	2000	100	410x50	2,1	1	155,60\$
206409	30	6500	3000	100	610x50	3,2	1	201,50\$
206415	46	6500	4600	100	910x50	4,8	1	263,00\$
206421	60	6500	6000	100	1210x50	7,5	1	356,60\$



DELLA

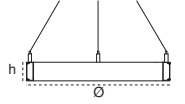

Code Kod	Power Güç (W)	Color Temp. Renk Sıcaklığı (K)	Luminous Flux Işık Akısı (lm)	Efficacy Etkinlik Faktörü (lm/W)	Dimensions Boyutlar (Øxh)	Package Weight Koli Ağırlığı (kg)	Pcs/Pack Koli Adedi	Price Fiyat
206426	27	4000	2700	100	410x50	2,1	1	155,60\$
206432	30	4000	3000	100	610x50	3,2	1	201,50\$
206438	46	4000	4600	100	910x50	4,8	1	263,00\$
206444	60	4000	6000	100	1210x50	7,5	1	356,60\$
206427	27	6500	2700	100	410x50	2,1	1	155,60\$
206433	30	6500	3000	100	610x50	3,2	1	201,50\$
206439	46	6500	4600	100	910x50	4,8	1	263,00\$
206445	60	6500	6000	100	1210x50	7,5	1	356,60\$

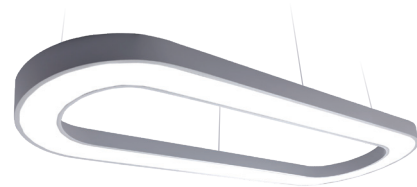

NORBA

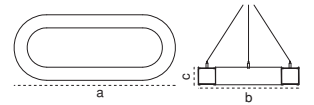

Code Kod	Power Güç (W)	Color Temp. Renk Sıcaklığı (K)	Luminous Flux Işık Akısı (lm)	Efficacy Etkinlik Faktörü (lm/W)	Dimensions Boyutlar (axbxc)	Package Weight Koli Ağırlığı (kg)	Pcs/Pack Koli Adedi	Price Fiyat
206474	85	4000	8800	104	1200x410x80	4,9	1	197,40\$
206480	105	4000	11000	105	1600x410x80	6,1	1	285,20\$
206475	85	6500	8800	104	1200x410x80	4,9	1	197,40\$
206481	105	6500	11000	105	1600x410x80	6,1	1	285,20\$



Code Kod	Features Özellikler	Pcs/Pack Koli Adedi	Price Fiyat
321505	4lü Hanger Set / Askı Takımı 1,5m RAL9005	1	14,40\$
321504	4lü Hanger Set / Askı Takımı 5m RAL9005	1	20,20\$
	For DALI / DALI Farkı	1	31,25\$

Code Kod	Features Özellikler	Pcs/Pack Koli Adedi	Price Fiyat
321177	4lü Hanger Set / Askı Takımı 1,5m RAL9006	1	14,40\$
321176	4lü Hanger Set / Askı Takımı 5m RAL9006	1	20,20\$



QUAD

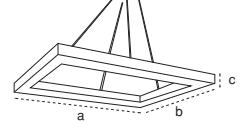

Code Kod	Power Güç (W)	Color Temp. Renk Sıcaklığı (K)	Luminous Flux Işık Akısı (lm)	Efficacy Etkinlik Faktörü (lm/W)	Dimensions Boyutlar (axbxc)	Package Weight Koli Ağırlığı (kg)	Pcs/Pack Koli Adedi	Price Fiyat
110132	40	4000	4600	115	420x420x82	3	1	117,90\$
110133	60	4000	6900	115	650x650x82	4,5	1	152,80\$
110134	80	4000	9200	115	920x920x82	7	1	241,30\$
110258	40	6500	4600	115	420x420x82	3	1	117,90\$
110261	60	6500	6900	115	650x650x82	4,5	1	152,80\$
110267	80	6500	9200	115	920x920x82	7	1	241,30\$

Aluminium Alüminyum	Opal Diffuser Opal Difüzör	3000/4000/6500K	IP40	50.000h	2 years / yıl	
150°	CRI 80	DALI	1-10V	Emergency Unit	RAL 9005	RAL 9006

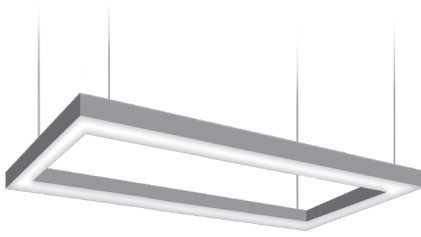

DETRA

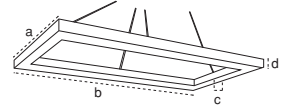

Code Kod	Power Güç (W)	Color Temp. Renk Sıcaklığı (K)	Luminous Flux Işık Akısı (lm)	Efficacy Etkinlik Faktörü (lm/W)	Dimensions Boyutlar (axbxcxd)	Package Weight Koli Ağırlığı (kg)	Pcs/Pack Koli Adedi	Price Fiyat
110135	80	4000	9200	115	650x1250x53x82	4,5	1	239,80\$
110264	80	6500	9200	115	650x1250x53x82	4,5	1	239,80\$

Aluminium Alüminyum	Opal Diffuser Opal Difüzör	3000/4000/6500K	IP40	50.000h	2 years / yıl	
150°	CRI 80	DALI	1-10V	Emergency Unit	RAL 9005	RAL 9006

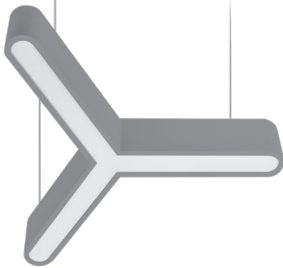

TRIA

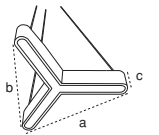

Code Kod	Power Güç (W)	Color Temp. Renk Sıcaklığı (K)	Luminous Flux Işık Akısı (lm)	Efficacy Etkinlik Faktörü (lm/W)	Dimensions Boyutlar (axbxc)	Package Weight Koli Ağırlığı (kg)	Pcs/Pack Koli Adedi	Price Fiyat
109141	85	4000	9775	115	1500x1300x80	7,5	1	249,00\$
110282	85	6500	9775	115	1500x1300x80	7,5	1	249,00\$

Aluminium Alüminyum	Opal Diffuser Opal Difüzör	3000/4000/6500K	IP40	50.000h	2 years / yıl	
150°	CRI 80	DALI	1-10V	Emergency Unit	RAL 9005	RAL 9006

Code Kod	Features Özellikler	Pcs/Pack Koli Adedi	Price Fiyat
321505	4lü Hanger Set / Askı Takımı 1,5m RAL9005	1	14,40\$
321504	4lü Hanger Set / Askı Takımı 5m RAL9005	1	20,20\$
	For DALI / DALI Farkı	1	31,25\$

Code Kod	Features Özellikler	Pcs/Pack Koli Adedi	Price Fiyat
321177	4lü Hanger Set / Askı Takımı 1,5m RAL9006	1	14,40\$
321176	4lü Hanger Set / Askı Takımı 5m RAL9006	1	20,20\$



PLENA

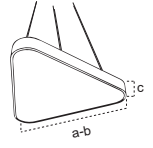

Code Kod	Power Güç (W)	Color Temp. Renk Sıcaklığı (K)	Luminous Flux Işık Akısı (lm)	Efficacy Etkinlik Faktörü (lm/W)	Dimensions Boyutlar (axbxc)	Package Weight Koli Ağırlığı (kg)	Pcs/Pack Koli Adedi	Price Fiyat
111152	45	4000	4600	102	600x600x80	4,2	1	191,70\$
111153	45	6500	4600	102	600x600x80	4,2	1	191,70\$

Aluminium Alüminyum	Opal Diffuser Opal Difüzör	3000/4000/6500K	IP40	50.000h	2 years / yıl	
150°	CRI 80	DALI	1-10V	Emergency Unit	RAL 9005	RAL 9006



ESSA

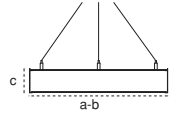

Code Kod	Power Güç (W)	Color Temp. Renk Sıcaklığı (K)	Luminous Flux Işık Akısı (lm)	Efficacy Etkinlik Faktörü (lm/W)	Dimensions Boyutlar (axbxc)	Package Weight Koli Ağırlığı (kg)	Pcs/Pack Koli Adedi	Price Fiyat
206450	50	4000	5500	110	610x530x80	4,5	1	130,40\$
206456	75	4000	8625	115	900x776x80	8,1	1	188,50\$
206451	50	6500	5500	110	610x530x80	4,5	1	130,40\$
206457	75	6500	8625	115	900x776x80	8,1	1	188,50\$

Aluminium Alüminyum	Opal Diffuser Opal Difüzör	3000/4000/6500K	IP20	50.000h	2 years / yıl
150°	DALI	1-10V	Emergency Unit	RAL 9005	RAL 9006

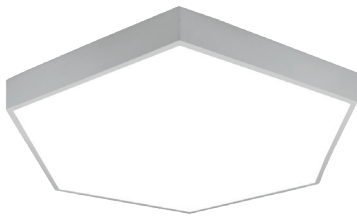

HEXA

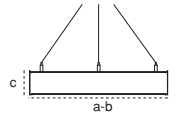

Code Kod	Power Güç (W)	Color Temp. Renk Sıcaklığı (K)	Luminous Flux Işık Akısı (lm)	Efficacy Etkinlik Faktörü (lm/W)	Dimensions Boyutlar (axbxc)	Package Weight Koli Ağırlığı (kg)	Pcs/Pack Koli Adedi	Price Fiyat
206462	50	4000	5500	110	610x530x80	4,8	1	161,00\$
206468	75	4000	8625	115	900x776x80	7	1	247,40\$
206463	50	6500	5500	110	610x530x80	4,8	1	161,00\$
206469	75	6500	8625	115	900x776x80	7	1	247,40\$

Aluminium Alüminyum	Opal Diffuser Opal Difüzör	3000/4000/6500K	IP20	50.000h	2 years / yıl
150°	DALI	1-10V	Emergency Unit	RAL 9005	RAL 9006

Code Kod	Features Özellikler	Pcs/Pack Koli Adedi	Price Fiyat
321505	4lü Hanger Set / Askı Takımı 1,5m RAL9005	1	14,40\$
321504	4lü Hanger Set / Askı Takımı 5m RAL9005	1	20,20\$
	For DALI / DALI Farkı	1	31,25\$

Code Kod	Features Özellikler	Pcs/Pack Koli Adedi	Price Fiyat
321177	4lü Hanger Set / Askı Takımı 1,5m RAL9006	1	14,40\$
321176	4lü Hanger Set / Askı Takımı 5m RAL9006	1	20,20\$

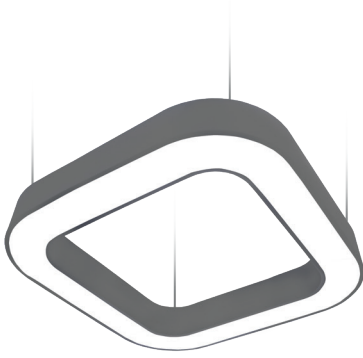

SMOOTH

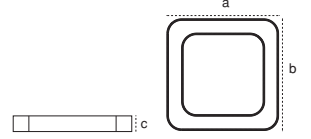

Code Kod	Power Güç (W)	Color Temp. Renk Sıcaklığı (K)	Luminous Flux Işık Akısı (lm)	Efficacy Etkinlik Faktörü (lm/W)	Dimensions Boyutlar (axbxc)	Package Weight Koli Ağırlığı (kg)	Pcs/Pack Koli Adedi	Price Fiyat
110136	50	4000	5500	110	600x600x80	4,5	1	176,00\$
110137	80	4000	9200	115	900x900x80	8	1	289,30\$
110270	50	6500	5500	110	600x600x80	4,5	1	176,00\$
110273	80	6500	9200	115	900x900x80	8	1	289,30\$



TWIST

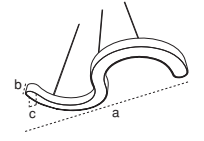

Code Kod	Power Güç (W)	Color Temp. Renk Sıcaklığı (K)	Luminous Flux Işık Akısı (lm)	Efficacy Etkinlik Faktörü (lm/W)	Dimensions Boyutlar (axbxc)	Package Weight Koli Ağırlığı (kg)	Pcs/Pack Koli Adedi	Price Fiyat
109130	45	4000	5175	115	1550x400x80	5,5	1	232,20\$
110281	45	6500	5175	115	1550x400x80	5,5	1	232,20\$

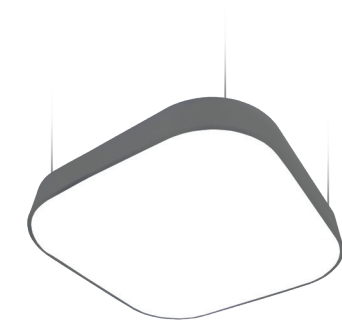

PIENO

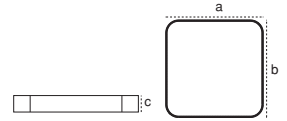

Code Kod	Power Güç (W)	Color Temp. Renk Sıcaklığı (K)	Luminous Flux Işık Akısı (lm)	Efficacy Etkinlik Faktörü (lm/W)	Dimensions Boyutlar (axbxc)	Package Weight Koli Ağırlığı (kg)	Pcs/Pack Koli Adedi	Price Fiyat
110138	50	4000	5750	115	600x600x80	4,5	1	233,60\$
110139	105	4000	12075	115	900x900x80	6	1	322,30\$
110276	50	6500	5750	115	600x600x80	4,5	1	233,60\$
110279	105	6500	12075	115	900x900x80	6	1	322,30\$

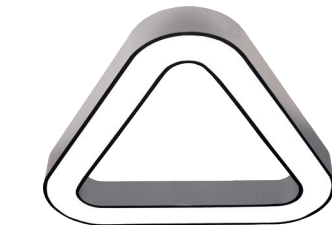

RADIA

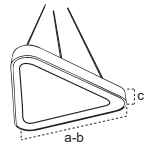

Code Kod	Power Güç (W)	Color Temp. Renk Sıcaklığı (K)	Luminous Flux Işık Akısı (lm)	Efficacy Etkinlik Faktörü (lm/W)	Dimensions Boyutlar (axbxc)	Package Weight Koli Ağırlığı (kg)	Pcs/Pack Koli Adedi	Price Fiyat
111148	30	4000	3300	110	600x600x80	3,9	1	160,70\$
111149	30	6500	3300	110	600x600x80	3,9	1	160,70\$



Code Kod	Features Özellikler	Pcs/Pack Koli Adedi	Price Fiyat
321505	4lü Hanger Set / Askı Takımı 1,5m RAL9005	1	14,40\$
321504	4lü Hanger Set / Askı Takımı 5m RAL9005	1	20,20\$
	For DALI / DALI Farkı	1	31,25\$

Code Kod	Features Özellikler	Pcs/Pack Koli Adedi	Price Fiyat
321177	4lü Hanger Set / Askı Takımı 1,5m RAL9006	1	14,40\$
321176	4lü Hanger Set / Askı Takımı 5m RAL9006	1	20,20\$



 **recta**
art and light

PENDANT LUMINAIRES
SARKIT ARMATÜRLER



VELVE

Code Kod	Type Tip	Base Duy	Luminous Flux Işık Akısı (lm)	Efficacy Etkinlik Faktörü (lm/W)	Dimensions Boyutlar (Øxh)	Package Weight Koli Ağırlığı (kg)	Pcs/Pack Koli Adedi	Price Fiyat
208154	White / Beyaz	E14	-	-	28x390	-	1	34,20\$
208155	Black / Siyah	E14	-	-	28x390	-	1	34,20\$
208156	Chromium Krom	E14	-	-	28x390	-	1	44,40\$
208157	Cooper /Bakır	E14	-	-	28x390	-	1	44,40\$
208158	Gold	E14	-	-	28x390	-	1	44,40\$

Metal IP20

It is a single price per product.
Tekli ürün fiyatlarıdır.

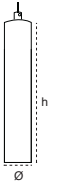

BIEN

Code Kod	Type Tip	Base Duy	Luminous Flux Işık Akısı (lm)	Efficacy Etkinlik Faktörü (lm/W)	Dimensions Boyutlar (Øxh)	Package Weight Koli Ağırlığı (kg)	Pcs/Pack Koli Adedi	Price Fiyat
208190	Black / Siyah	E14	-	-	28x300	-	1	34,20\$
208191	White / Beyaz	E14	-	-	28x300	-	1	34,20\$
208192	Chromium / Krom	E14	-	-	28x300	-	1	42,90\$
208193	Copper / Bakır	E14	-	-	28x300	-	1	42,90\$
208194	Gold	E14	-	-	28x300	-	1	42,90\$

Metal IP20

It is a single price per product.
Tekli ürün fiyatlarıdır.

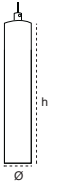

COSMIC

Code Kod	Type Tip	Base Duy	Luminous Flux Işık Akısı (lm)	Efficacy Etkinlik Faktörü (lm/W)	Dimensions Boyutlar (Øxh)	Package Weight Koli Ağırlığı (kg)	Pcs/Pack Koli Adedi	Price Fiyat
208195	Black / Siyah	E14	-	-	28x600	-	1	37,20\$
208196	White / Beyaz	E14	-	-	28x600	-	1	37,20\$
208197	Chromium / Krom	E14	-	-	28x600	-	1	47,70\$
208198	Cooper /Bakır	E14	-	-	28x600	-	1	47,70\$
208199	Gold	E14	-	-	28x600	-	1	47,70\$

Metal IP20

It is a single price per product.
Tekli ürün fiyatlarıdır.



LORIN (Set)

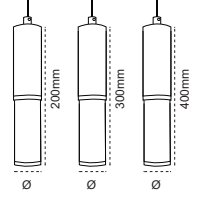

Code Kod	Power Güç (W)	Color Temp. Renk Sıcaklığı (K)	Luminous Flux Işık Akısı (lm)	Efficacy Etkinlik Faktörü (lm/W)	Dimensions Boyutlar (Øxh)	Package Weight Koli Ağırlığı (kg)	Pcs/Pack Koli Adedi	Price Fiyat
208159	Gu10	-	-	-	55	-	1	131,10\$

Metal IP20



RIMA



Code Kod	Type Tip	Base Duy	Luminous Flux Işık Akısı (lm)	Efficacy Etkinlik Faktörü (lm/W)	Dimensions Boyutlar (Øxh)	Package Weight Koli Ağırlığı (kg)	Pcs/Pack Koli Adedi	Price Fiyat
208205	Black / Siyah	E14	-	-	51x400	-	1	28,10\$
208206	White / Beyaz	E14	-	-	51x400	-	1	28,10\$
208207	Chromium Krom	E14	-	-	51x400	-	1	39,30\$
208208	Cooper /Bakır	E14	-	-	51x400	-	1	39,30\$
208209	Gold	E14	-	-	51x400	-	1	39,30\$

Metal IP20

It is a single price per product.
Tekli ürün fiyatlarıdır.



ROME

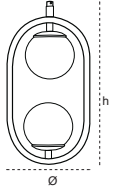

Code Kod	Type Tip	Base Duy	Luminous Flux Işık Akısı (lm)	Efficacy Etkinlik Faktörü (lm/W)	Dimensions Boyutlar (Øxh)	Package Weight Koli Ağırlığı (kg)	Pcs/Pack Koli Adedi	Price Fiyat
208160	Cooper /Bakır	2xE27	-	-	200x470	-	1	68,40\$
208161	Black / Siyah	2xE27	-	-	200x470	-	1	52,00\$
208162	Gold	2xE27	-	-	200x470	-	1	68,40\$

Metal Glass Cam IP20

It is a single price per product.
Tekli ürün fiyatlarıdır.



VIerno



Code Kod	Type Tip	Base Duy	Luminous Flux Işık Akısı (lm)	Efficacy Etkinlik Faktörü (lm/W)	Dimensions Boyutlar (Øxh)	Package Weight Koli Ağırlığı (kg)	Pcs/Pack Koli Adedi	Price Fiyat
208200	Black / Siyah	E27	-	-	51x250	-	1	21,90\$
208201	White / Beyaz	E27	-	-	51x250	-	1	21,90\$
208202	Chromium Krom	E27	-	-	51x250	-	1	30,90\$
208203	Cooper /Bakır	E27	-	-	51x250	-	1	30,90\$
208204	Gold	E27	-	-	51x250	-	1	30,90\$

Metal IP20

It is a single price per product.
Tekli ürün fiyatlarıdır.



ARTELIA

Code Kod	Type Tip	Base Duy	Luminous Flux Işık Akısı (lm)	Efficacy Etkinlik Faktörü (lm/W)	Dimensions Boyutlar (Øxh)	Package Weight Koli Ağırlığı (kg)	Pcs/Pack Koli Adedi	Price Fiyat
208163	Cooper / Bakır	E27	-	-	200x470	-	1	58,20\$
208164	Black / Siyah	E27	-	-	200x470	-	1	40,30\$
208165	Gold	E27	-	-	200x470	-	1	58,20\$



It is a single price per product.
Tekli ürün fiyatlarıdır.

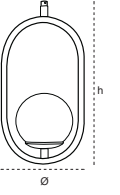

ALIN

Code Kod	Type Tip	Base Duy	Luminous Flux Işık Akısı (lm)	Efficacy Etkinlik Faktörü (lm/W)	Dimensions Boyutlar (Øxh)	Package Weight Koli Ağırlığı (kg)	Pcs/Pack Koli Adedi	Price Fiyat
208187	Cooper / Bakır	E27	-	-	200x500	-	1	57,70\$
208188	Black / Siyah	E27	-	-	200x500	-	1	47,70\$
208189	Gold	E27	-	-	200x500	-	1	57,70\$



It is a single price per product.
Tekli ürün fiyatlarıdır.

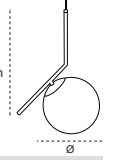

NILA

Code Kod	Type Tip	Base Duy	Luminous Flux Işık Akısı (lm)	Efficacy Etkinlik Faktörü (lm/W)	Dimensions Boyutlar (Øxh)	Package Weight Koli Ağırlığı (kg)	Pcs/Pack Koli Adedi	Price Fiyat
208168	Black / Siyah	E27	-	-	340X240	-	1	33,20\$
208169	White / Beyaz	E27	-	-	340X240	-	1	33,20\$
208170	Fuchsia / Fuşya	E27	-	-	340X240	-	1	33,20\$
208171	Red / Kırmızı	E27	-	-	340x240	-	1	33,20\$
208172	Mint	E27	-	-	340x240	-	1	33,20\$
208173	Yellow / Sarı	E27	-	-	340x240	-	1	33,20\$

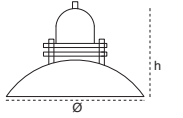

ARTIC

Code Kod	Type Tip	Base Duy	Luminous Flux Işık Akısı (lm)	Efficacy Etkinlik Faktörü (lm/W)	Dimensions Boyutlar (Øxh)	Package Weight Koli Ağırlığı (kg)	Pcs/Pack Koli Adedi	Price Fiyat
208166	Black / Siyah	E27	-	-	300x270	-	1	34,20\$
208167	White / Beyaz	E27	-	-	300x270	-	1	34,20\$

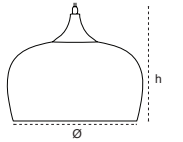

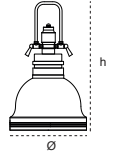

NIA

Code Kod	Power Güç (W)	Color Temp. Renk Sıcaklığı (K)	Luminous Flux Işık Akısı (lm)	Efficacy Etkinlik Faktörü (lm/W)	Dimensions Boyutlar (Øxh)	Package Weight Koli Ağırlığı (kg)	Pcs/Pack Koli Adedi	Price Fiyat
208153	E27	-	-	-	300x270	-	1	50,50\$

Metal IP20

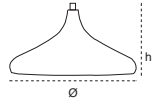

VILA

Code Kod	Power Güç (W)	Color Temp. Renk Sıcaklığı (K)	Luminous Flux Işık Akısı (lm)	Efficacy Etkinlik Faktörü (lm/W)	Dimensions Boyutlar (Øxh)	Package Weight Koli Ağırlığı (kg)	Pcs/Pack Koli Adedi	Price Fiyat
208174	E27	-	-	-	350x200	-	1	23,00\$

Metal IP20

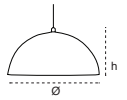

PANTONE

Code Kod	Type Tip	Base Duy	Luminous Flux Işık Akısı (lm)	Efficacy Etkinlik Faktörü (lm/W)	Dimensions Boyutlar (Øxh)	Package Weight Koli Ağırlığı (kg)	Pcs/Pack Koli Adedi	Price Fiyat
208175	Black / Siyah	E27	-	-	400x230	-	1	31,10\$
208176	White / Beyaz	E27	-	-	400x230	-	1	31,10\$
208177	Patina	E27	-	-	400x230	-	1	40,30\$
208178	Red / Kırmızı	E27	-	-	400x230	-	1	31,10\$
208179	Yellow / Sarı	E27	-	-	400x230	-	1	31,10\$
208180	Black / Siyah	E27	-	-	500x300	-	1	50,50\$
208181	Patina	E27	-	-	500x300	-	1	64,80\$

Metal IP20

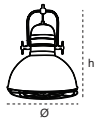

TRENOS

Code Kod	Type Tip	Base Duy	Luminous Flux Işık Akısı (lm)	Efficacy Etkinlik Faktörü (lm/W)	Dimensions Boyutlar (Øxh)	Package Weight Koli Ağırlığı (kg)	Pcs/Pack Koli Adedi	Price Fiyat
208182	Black / Siyah	E27	-	-	400x530	-	1	94,10\$
208183	White / Beyaz	E27	-	-	400x530	-	1	94,10\$
208184	Patina	E27	-	-	400x530	-	1	115,80\$
208185	Red / Kırmızı	E27	-	-	400x530	-	1	94,10\$
208186	Yellow / Sarı	E27	-	-	400x530	-	1	94,10\$

Metal IP20



 **recta**
a r t a n d l i g h t

DOWNLIGHT and SPOT LUMINAIRES
DOWNLIGHT ve SPOT ARMATÜRLER



CAMIO ROUND
CAMIO YUVARLAK

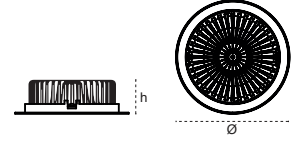

Code Kod	Power Güç (W)	Color Temp. Renk Sıcaklığı (K)	Luminous Flux Işık Akısı (lm)	Efficacy Etkinlik Faktörü (lm/W)	Dimensions Boyutlar (Øxh)	Cut Size Kesim Ölç. (mm)	Package Weight Koli Ağırlığı (kg)	Pcs/Pack Koli Adedi	Price Fiyat
207534	15	3000	1350	90	190x80	170	0,82	1	44,00\$
207535	15	4000	1350	90	190x80	170	0,82	1	44,00\$
207536	15	6500	1350	90	190x80	170	0,82	1	44,00\$
207540	20	3000	1774	88	190x80	170	0,84	1	45,10\$
207541	20	4000	1774	88	190x80	170	0,84	1	45,10\$
207542	20	6500	1774	88	190x80	170	0,84	1	45,10\$
207546	30	3000	2938	97	190x80	170	0,84	1	48,10\$
207547	30	4000	2938	97	190x80	170	0,84	1	48,10\$
207548	30	6500	2938	97	190x80	170	0,84	1	48,10\$

- Aluminium Alüminyum Aluminium Reflector Alüminyum Reflektör Opal 3000/4000/6500K IP20 50.000h 2 years / yıl
 60° DALI Emergency Unit CRI 80 CRI 90 RAL 9016



CAMIO SQUARE
CAMIO KARE

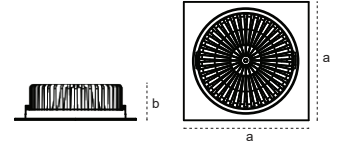

Code Kod	Power Güç (W)	Color Temp. Renk Sıcaklığı (K)	Luminous Flux Işık Akısı (lm)	Efficacy Etkinlik Faktörü (lm/W)	Dimensions Boyutlar (axb)	Cut Size Kesim Ölç. (mm)	Package Weight Koli Ağırlığı (kg)	Pcs/Pack Koli Adedi	Price Fiyat
207570	15	3000	1350	90	190x80	170	0,915	1	44,20\$
207571	15	4000	1350	90	190x80	170	0,915	1	44,20\$
207572	15	6500	1350	90	190x80	170	0,915	1	44,20\$
207576	20	3000	1774	88	190x80	170	0,925	1	45,20\$
207577	20	4000	1774	88	190x80	170	0,925	1	45,20\$
207578	20	6500	1774	88	190x80	170	0,925	1	45,20\$
207582	30	3000	2938	97	190x80	170	0,925	1	48,30\$
207583	30	4000	2938	97	190x80	170	0,925	1	48,30\$
207584	30	6500	2938	97	190x80	170	0,925	1	48,30\$

- Aluminium Alüminyum Aluminium Reflector Alüminyum Reflektör Opal 3000/4000/6500K IP20 50.000h 2 years / yıl
 60° DALI Emergency Unit CRI 80 CRI 90 RAL 9016



VIONE

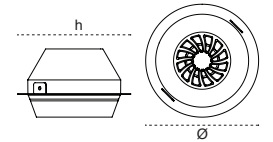

Code Kod	Power Güç (W)	Color Temp. Renk Sıcaklığı (K)	Luminous Flux Işık Akısı (lm)	Efficacy Etkinlik Faktörü (lm/W)	Dimensions Boyutlar (Øxh)	Cut Size Kesim Ölç. (mm)	Package Weight Koli Ağırlığı (kg)	Pcs/Pack Koli Adedi	Price Fiyat
207504	20	3000	2060	103	155x139	130	0,825	1	41,80\$
207505	20	4000	2060	103	155x139	130	0,825	1	41,80\$
207506	20	6500	2060	103	155x139	130	0,825	1	41,80\$
207510	30	3000	3150	105	155x139	130	0,835	1	44,90\$
207511	30	4000	3150	105	155x139	130	0,835	1	44,90\$
207512	30	6500	3150	105	155x139	130	0,835	1	44,90\$

- Aluminium Alüminyum Aluminium Reflector Alüminyum Reflektör Clear Glass Şeffaf Cam 3000/4000/6500K IP20 50.000h 2 years / yıl
 15° / 30° / 45° / 60° DALI Emergency Unit CRI 80 CRI 90 RAL 9016



TILLA ROUND
TILLA YUVARLAK

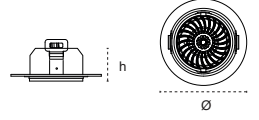

Code Kod	Power Güç (W)	Color Temp. Renk Sıcaklığı (K)	Luminous Flux Işık Akısı (lm)	Efficacy Etkinlik Faktörü (lm/W)	Dimensions Boyutlar (Øxh)	Cut Size Kesim Ölç. (mm)	Package Weight Koli Ağırlığı (kg)	Pcs/Pack Koli Adedi	Price Fiyat
207636	8	3000	587	73	115x90	100	0,245	1	24,20\$
207637	8	4000	587	73	115x90	100	0,245	1	24,20\$
207638	8	6500	587	73	115x90	100	0,245	1	24,20\$

- Aluminium Alüminyum
- Aluminium Reflector Alüminyum Reflektör
- Clear Glass Şeffaf Cam
- 3000/4000/6500K
- IP20
- 50.000h
- 2 years / yıl
- 15° / 30°
- DALI
- Emergency Unit
- CRI 80
- CRI 90
- Gu10 Option Gu10 Opsiyonu
- RAL 9016



TILLA SQUARE
TILLA KARE

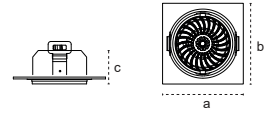

Code Kod	Power Güç (W)	Color Temp. Renk Sıcaklığı (K)	Luminous Flux Işık Akısı (lm)	Efficacy Etkinlik Faktörü (lm/W)	Dimensions Boyutlar (axbxc)	Cut Size Kesim Ölç. (mm)	Package Weight Koli Ağırlığı (kg)	Pcs/Pack Koli Adedi	Price Fiyat
207612	8	3000	587	73	115x115x90	100	0,26	1	24,20\$
207613	8	4000	587	73	115x115x90	100	0,26	1	24,20\$
207614	8	6500	587	73	115x115x90	100	0,26	1	24,20\$

- Aluminium Alüminyum
- Aluminium Reflector Alüminyum Reflektör
- Clear Glass Şeffaf Cam
- 3000/4000/6500K
- IP20
- 50.000h
- 2 years / yıl
- 15° / 30°
- DALI
- Emergency Unit
- CRI 80
- CRI 90
- Gu10 Option Gu10 Opsiyonu
- RAL 9016

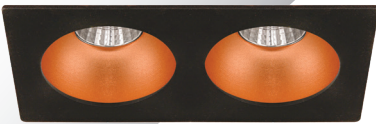

TILLA SQUARE
TILLA KARE

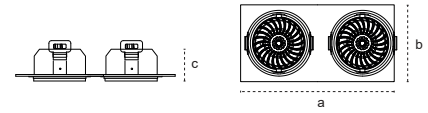

Code Kod	Power Güç (W)	Color Temp. Renk Sıcaklığı (K)	Luminous Flux Işık Akısı (lm)	Efficacy Etkinlik Faktörü (lm/W)	Dimensions Boyutlar (axbxc)	Cut Size Kesim Ölç. (mm)	Package Weight Koli Ağırlığı (kg)	Pcs/Pack Koli Adedi	Price Fiyat
207669	2x8	3000	1242	77	230x115x90	215x100	0,53	1	44,00\$
207670	2x8	4000	1242	77	230x115x90	215x100	0,53	1	44,00\$
207671	2x8	6500	1242	77	230x115x90	215x100	0,53	1	44,00\$
207672	2x10	3000	1774	88	230x115x90	215x100	0,53	1	46,10\$
207673	2x10	4000	1774	88	230x115x90	215x100	0,53	1	46,10\$
207674	2x10	6500	1774	88	230x115x90	215x100	0,53	1	46,10\$

- Aluminium Alüminyum
- Aluminium Reflector Alüminyum Reflektör
- Clear Glass Şeffaf Cam
- 3000/4000/6500K
- IP20
- 50.000h
- 2 years / yıl
- 15° / 30°
- DALI
- Emergency Unit
- CRI 80
- CRI 90
- Gu10 Option Gu10 Opsiyonu
- RAL 9016



LISSO S

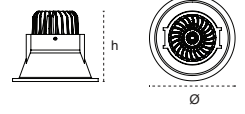

Code Kod	Power Güç (W)	Color Temp. Renk Sıcaklığı (K)	Luminous Flux Işık Akısı (lm)	Efficacy Etkinlik Faktörü (lm/W)	Dimensions Boyutlar (Øxh)	Cut Size Kesim Ölç. (mm)	Package Weight Koli Ağırlığı (kg)	Pcs/Pack Koli Adedi	Price Fiyat
207115	8	3000	832	104	100x82	90	0,325	1	20,70\$
207116	8	4000	832	104	100x82	90	0,325	1	20,70\$
207117	8	6500	832	104	100x82	90	0,325	1	20,70\$

- Aluminium Alüminyum
- Aluminium Reflector Alüminyum Reflektör
- Clear Glass Şeffaf Cam
- 3000/4000/6500K
- IP20
- 50.000h
- 2 years / yıl
- 15° / 30°
- DALI
- Emergency Unit
- CRI 80
- CRI 90
- RAL 9016



LISSO M

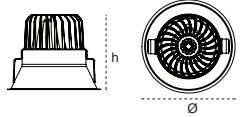

Code Kod	Power Güç (W)	Color Temp. Renk Sıcaklığı (K)	Luminous Flux Işık Akısı (lm)	Efficacy Etkinlik Faktörü (lm/W)	Dimensions Boyutlar (Øxh)	Cut Size Kesim Ölç. (mm)	Package Weight Koli Ağırlığı (kg)	Pcs/Pack Koli Adedi	Price Fiyat
207136	20	3000	2080	104	144x136	135	0,975	1	38,50\$
207137	20	4000	2080	104	144x136	135	0,975	1	38,50\$
207138	20	6500	2080	104	144x136	135	0,975	1	38,50\$
207163	30	3000	3090	103	144x136	135	0,975	1	40,60\$
207164	30	4000	3090	103	144x136	135	0,975	1	40,60\$
207165	30	6500	3090	103	144x136	135	0,975	1	40,60\$

- Aluminium Alüminyum
- Aluminium Reflector Alüminyum Reflektör
- Clear Glass Şeffaf Cam
- 3000/4000/6500K
- IP20
- 50.000h
- 2 years / yıl
- 15° / 30° / 45° / 60°
- DALI
- Emergency Unit
- CRI 80
- CRI 90
- RAL 9016



LISSO L

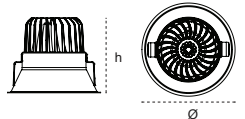

Code Kod	Power Güç (W)	Color Temp. Renk Sıcaklığı (K)	Luminous Flux Işık Akısı (lm)	Efficacy Etkinlik Faktörü (lm/W)	Dimensions Boyutlar (Øxh)	Cut Size Kesim Ölç. (mm)	Package Weight Koli Ağırlığı (kg)	Pcs/Pack Koli Adedi	Price Fiyat
207184	30	3000	3090	103	178x142	170	1,215	1	41,80\$
207185	30	4000	3090	103	178x142	170	1,215	1	41,80\$
207186	30	6500	3090	103	178x142	170	1,215	1	41,80\$
207211	35	3000	3570	102	178x142	170	1,215	1	42,90\$
207212	35	4000	3570	102	178x142	170	1,215	1	42,90\$
207213	35	6500	3570	102	178x142	170	1,215	1	42,90\$

- Aluminium Alüminyum
- Aluminium Reflector Alüminyum Reflektör
- Clear Glass Şeffaf Cam
- 3000/4000/6500K
- IP20
- 50.000h
- 2 years / yıl
- 15° / 30° / 45° / 60°
- DALI
- Emergency Unit
- CRI 80
- CRI 90
- RAL 9016

BELLA (Gu10)

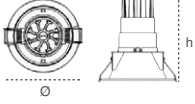

Code Kod	Body Colour Gövde Rengi	Base Duy	Color Temp. Renk Sıcaklığı (K)	Luminous Flux Işık Akısı (lm)	Efficacy Etkinlik Faktörü (lm/W)	Dimensions Boyutlar (Øxh)	Cut Size Kesim Ölç. (mm)	Package Weight Koli Ağırlığı (kg)	Pcs/Pack Koli Adedi	Price Fiyat
206258	Black/White Siyah/Beyaz	Gu10	-	-	-	95x120	80	10,08	36	3,95\$
205784	Black/Black Siyah/Siyah	Gu10	-	-	-	95x120	80	10,08	36	3,95\$
205787	Black/Gold Siyah/Altın	Gu10	-	-	-	95x120	80	10,08	36	9,40\$
205790	Black/Platin Siyah/Platin	Gu10	-	-	-	95x120	80	10,08	36	9,40\$
205793	Black/Rose Siyah/Rose	Gu10	-	-	-	95x120	80	10,08	36	9,40\$

Aluminium Alüminyum	IP20	36.000h	2 years / yıl	18° / 24° / 36°	Trimless Options Trimless Opsiyonu	Semi Recessed Mounted Yarı Gömme Montaj	Pendant Mounted Sarkıt Montaj	Gu10 Option Gu10 Opsiyonu
Emergency Unit								

BELLA (Gu10)

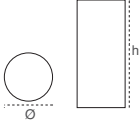

Code Kod	Body Colour Gövde Rengi	Base Duy	Color Temp. Renk Sıcaklığı (K)	Luminous Flux Işık Akısı (lm)	Efficacy Etkinlik Faktörü (lm/W)	Dimensions Boyutlar (Øxh)	Package Weight Koli Ağırlığı (kg)	Pcs/Pack Koli Adedi	Price Fiyat
206262	Black/White Siyah/Beyaz	Gu10	-	-	-	80x105	5,22	18	20,40\$
205808	Black/Black Siyah/Siyah	Gu10	-	-	-	80x105	5,22	18	20,40\$
205811	Black/Gold Siyah/Altın	Gu10	-	-	-	80x105	5,22	18	25,15\$
205814	Black/Platin Siyah/Platin	Gu10	-	-	-	80x105	5,22	18	25,15\$
205817	Black/Rose Siyah/Rose	Gu10	-	-	-	80x105	5,22	18	25,15\$

Aluminium Alüminyum	IP20	36.000h	2 years / yıl	18° / 24° / 36°	Trimless Options Trimless Opsiyonu	Semi Recessed Mounted Yarı Gömme Montaj	Pendant Mounted Sarkıt Montaj	Gu10 Option Gu10 Opsiyonu
Emergency Unit								

STELLA (Gu10)

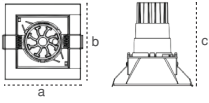

Code Kod	Body Colour Gövde Rengi	Base Duy	Color Temp. Renk Sıcaklığı (K)	Luminous Flux Işık Akısı (lm)	Efficacy Etkinlik Faktörü (lm/W)	Dimensions Boyutlar (a x b x c)	Cut Size Kesim Ölç. (mm)	Package Weight Koli Ağırlığı (kg)	Pcs/Pack Koli Adedi	Price Fiyat
206260	Black/White Siyah/Beyaz	Gu10	-	-	-	90x90x120	80	11,52	36	3,95\$
205880	Black/Black Siyah/Siyah	Gu10	-	-	-	90x90x120	80	11,52	36	3,95\$
205883	Black/Gold Siyah/Altın	Gu10	-	-	-	90x90x120	80	11,52	36	9,40\$
205886	Black/Platin Siyah/Platin	Gu10	-	-	-	90x90x120	80	11,52	36	9,40\$
205889	Black/Rose Siyah/Rose	Gu10	-	-	-	90x90x120	80	11,52	36	9,40\$

Aluminium Alüminyum	IP20	36.000h	2 years / yıl	18° / 24° / 36°	Trimless Options Trimless Opsiyonu	Semi Recessed Mounted Yarı Gömme Montaj	Pendant Mounted Sarkıt Montaj	Gu10 Option Gu10 Opsiyonu
Emergency Unit								

STELLA (Gu10)



Code Kod	Body Colour Gövde Rengi	Base Duy	Color Temp. Renk Sıcaklığı (K)	Luminous Flux Işık Akısı (lm)	Efficacy Etkinlik Faktörü (lm/W)	Dimensions Boyutlar (a x b x c)	Package Weight Koli Ağırlığı (kg)	Pcs/Pack Koli Adedi	Price Fiyat
206664	Black/White Siyah/Beyaz	Gu10	-	-	-	75x75x105	6,03	18	20,40\$
205892	Black/Black Siyah/Siyah	Gu10	-	-	-	75x75x105	6,03	18	20,40\$
205895	Black/Gold Siyah/Altın	Gu10	-	-	-	75x75x105	6,03	18	25,15\$
205898	Black/Platin Siyah/Platin	Gu10	-	-	-	75x75x105	6,03	18	25,15\$
205901	Black/Rose Siyah/Rose	Gu10	-	-	-	75x75x105	6,03	18	25,15\$

Aluminium Alüminyum	IP20	36.000h	2 years / yıl	18° / 24° / 36°	Trimless Options Trimless Opsiyonu	Semi Recessed Mounted Yarı Gömme Montaj	Pendant Mounted Sarkıt Montaj	Gu10 Option Gu10 Opsiyonu
Emergency Unit								

BELLA (LED)

Code Kod	Body Colour Gövde Rengi	Power Güç (W)	Color Temp. Renk Sıcaklığı (K)	Luminous Flux Işık Akısı (lm)	Efficacy Etkinlik Faktörü (lm/W)	Dimensions Boyutlar (Øxh)	Cut Size Kesim Ölç. (mm)	Package Weight Koli Ağırlığı (kg)	Pcs/Pack Koli Adedi	Price Fiyat
205782	Black / Black Siyah / Siyah	8	4000	848	106	95x110	80	18	36	25,80\$
205783	Black / Black Siyah / Siyah	11	4000	1045	95	95x110	80	18	36	25,80\$
205785	Black / Gold Siyah / Gold	8	4000	848	106	95x110	80	18	36	31,90\$
205786	Black / Gold Siyah / Gold	11	4000	1045	95	95x110	80	18	36	31,90\$
205788	Black / Platin Siyah / Platin	8	4000	848	106	95x110	80	18	36	31,90\$
205789	Black / Platin Siyah / Platin	11	4000	1045	95	95x110	80	18	36	31,90\$
205791	Black / Rose Siyah / Rose	8	4000	848	106	95x110	80	18	36	31,90\$
205792	Black / Rose Siyah / Rose	11	4000	1045	95	95x110	80	18	36	31,90\$

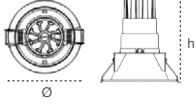

- Aluminium Alüminyum
- IP20
- 36.000h
- 2 years / yıl
- 18° / 24° / 36°
- Trimless Options Trimless Opsiyonu
- Semi Recessed Mounted Yan Gömme Montaj
- Pendant Mounted Sarkıt Montaj
- Gu10 Option Gu10 Opsiyonu
- Emergency Unit
- DALI

BELLA (LED)

Code Kod	Body Colour Gövde Rengi	Power Güç (W)	Color Temp. Renk Sıcaklığı (K)	Luminous Flux Işık Akısı (lm)	Efficacy Etkinlik Faktörü (lm/W)	Dimensions Boyutlar (Øxh)	Package Weight Koli Ağırlığı (kg)	Pcs/Pack Koli Adedi	Price Fiyat
205806	Black / Black Siyah / Siyah	8	4000	848	106	80x150	9	18	40,80\$
205807	Black / Black Siyah / Siyah	11	4000	1045	95	80x150	9	18	40,80\$
205809	Black / Gold Siyah / Gold	8	4000	848	106	80x150	9	18	46,90\$
205810	Black / Gold Siyah / Gold	11	4000	1045	95	80x150	9	18	46,90\$
205812	Black / Platin Siyah / Platin	8	4000	848	106	80x150	9	18	46,90\$
205813	Black / Platin Siyah / Platin	11	4000	1045	95	80x150	9	18	46,90\$
205815	Black / Rose Siyah / Rose	8	4000	848	106	80x150	9	18	46,90\$
205816	Black / Rose Siyah / Rose	11	4000	1045	95	80x150	9	18	46,90\$

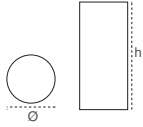

- Aluminium Alüminyum
- IP20
- 36.000h
- 2 years / yıl
- 18° / 24° / 36°
- Trimless Options Trimless Opsiyonu
- Semi Recessed Mounted Yan Gömme Montaj
- Pendant Mounted Sarkıt Montaj
- Gu10 Option Gu10 Opsiyonu
- Emergency Unit
- DALI

STELLA (LED)

Code Kod	Body Colour Gövde Rengi	Power Güç (W)	Color Temp. Renk Sıcaklığı (K)	Luminous Flux Işık Akısı (lm)	Efficacy Etkinlik Faktörü (lm/W)	Dimensions Boyutlar (axbxc)	Cut Size Kesim Ölç. (mm)	Package Weight Koli Ağırlığı (kg)	Pcs/Pack Koli Adedi	Price Fiyat
205878	Black / Black Siyah / Siyah	8	4000	848	106	90x90x110	75	18	36	25,80\$
205879	Black / Black Siyah / Siyah	11	4000	1045	95	90x90x110	75	18	36	25,80\$
205881	Black / Gold Siyah / Gold	8	4000	848	106	90x90x110	75	18	36	31,90\$
205882	Black / Gold Siyah / Gold	11	4000	1045	95	90x90x110	75	18	36	31,90\$
205884	Black / Platin Siyah / Platin	8	4000	848	106	90x90x110	75	18	36	31,90\$
205885	Black / Platin Siyah / Platin	11	4000	1045	95	90x90x110	75	18	36	31,90\$
205887	Black / Rose Siyah / Rose	8	4000	848	106	90x90x110	75	18	36	31,90\$
205888	Black / Rose Siyah / Rose	11	4000	1045	95	90x90x110	75	18	36	31,90\$

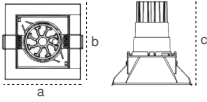
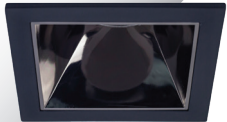

- Aluminium Alüminyum
- IP20
- 36.000h
- 2 years / yıl
- 18° / 24° / 36°
- Trimless Options Trimless Opsiyonu
- Semi Recessed Mounted Yan Gömme Montaj
- Pendant Mounted Sarkıt Montaj
- Gu10 Option Gu10 Opsiyonu
- Emergency Unit
- DALI

STELLA (LED)

Code Kod	Body Colour Gövde Rengi	Power Güç (W)	Color Temp. Renk Sıcaklığı (K)	Luminous Flux Işık Akısı (lm)	Efficacy Etkinlik Faktörü (lm/W)	Dimensions Boyutlar (axbxc)	Package Weight Koli Ağırlığı (kg)	Pcs/Pack Koli Adedi	Price Fiyat
205890	Black / Black Siyah / Siyah	8	4000	848	106	150x75x75	9	18	40,80\$
205891	Black / Black Siyah / Siyah	11	4000	1045	95	150x75x75	9	18	40,80\$
205893	Black / Gold Siyah / Gold	8	4000	848	106	150x75x75	9	18	46,90\$
205894	Black / Gold Siyah / Gold	11	4000	1045	95	150x75x75	9	18	46,90\$
205896	Black / Platin Siyah / Platin	8	4000	848	106	150x75x75	9	18	46,90\$
205897	Black / Platin Siyah / Platin	11	4000	1045	95	150x75x75	9	18	46,90\$
205899	Black / Rose Siyah / Rose	8	4000	848	106	150x75x75	9	18	46,90\$
205900	Black / Rose Siyah / Rose	11	4000	1045	95	150x75x75	9	18	46,90\$

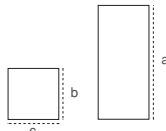

- Aluminium Alüminyum
- IP20
- 36.000h
- 2 years / yıl
- 18° / 24° / 36°
- Trimless Options Trimless Opsiyonu
- Semi Recessed Mounted Yan Gömme Montaj
- Pendant Mounted Sarkıt Montaj
- Gu10 Option Gu10 Opsiyonu
- Emergency Unit
- DALI



BELLA TRIMLESS (Gu10)

Code Kod	Body Colour Gövde Rengi	Base Duy	Color Temp. Renk Sıcaklığı (K)	Luminous Flux Işık Akısı (lm)	Efficacy Etkinlik Faktörü (lm/W)	Dimensions Boyutlar (ØxH)	Package Weight Koli Ağırlığı (kg)	Pcs/Pack Koli Adedi	Price Fiyat
206254	Black/White Siyah/Beyaz	Gu10	-	-	-	140x80	-	-	6,95\$
205796	Black/Black Siyah/Siyah	Gu10	-	-	-	140x80	-	-	6,95\$
205799	Black/Gold Siyah/Altın	Gu10	-	-	-	140x80	-	-	12,40\$
205802	Black/Platin Siyah/Platin	Gu10	-	-	-	140x80	-	-	12,40\$
205805	Black/Rose Siyah/Rose	Gu10	-	-	-	140x80	-	-	12,40\$

Aluminium Alüminyum IP20 36.000h 2 years / yıl 18° / 24° / 36° Trimless Options Trimless Opsiyonu Semi Recessed Mounted Yarı Gömme Montaj Pendant Mounted Sarkıt Montaj Gu10 Option Gu10 Opsiyonu
Emergency Unit DALI

BELLA TRIMLESS (LED)

Code Kod	Body Colour Gövde Rengi	Power Güç (W)	Color Temp. Renk Sıcaklığı (K)	Luminous Flux Işık Akısı (lm)	Efficacy Etkinlik Faktörü (lm/W)	Dimensions Boyutlar (ØxH)	Package Weight Koli Ağırlığı (kg)	Pcs/Pack Koli Adedi	Price Fiyat
209639	Black / White/ Siyah / Beyaz	8	4000	848	106	140x80	2,25	1	43,80\$
209640	Black / White/ Siyah / Beyaz	11	4000	1045	95	140x80	2,25	1	43,80\$
205794	Black Black / Siyah / Siyah	8	4000	848	106	140x80	2,25	1	43,80\$
205795	Black Black / Siyah / Siyah	11	4000	1045	95	140x80	2,25	1	43,80\$
205797	Black / Gold / Siyah / Altın	8	4000	848	106	140x80	2,25	1	50,00\$
205798	Black / Gold / Siyah / Altın	11	4000	1045	95	140x80	2,25	1	50,00\$
205800	Black /Platin / Siyah /Platin	8	4000	848	106	140x80	2,25	1	50,00\$
205801	Black /Platin / Siyah /Platin	11	4000	1045	95	140x80	2,25	1	50,00\$
205803	Black /Rose Siyah /Rose	8	4000	848	106	140x80	2,25	1	50,00\$
205804	Black /Rose Siyah /Rose	11	4000	1045	95	140x80	2,25	1	50,00\$

Aluminium Alüminyum IP20 36.000h 2 years / yıl 18° / 24° / 36° Trimless Options Trimless Opsiyonu Semi Recessed Mounted Yarı Gömme Montaj Pendant Mounted Sarkıt Montaj Gu10 Option Gu10 Opsiyonu
Emergency Unit DALI



STELLA TRIMLESS (LED)

Code Kod	Body Colour Gövde Rengi	Base Duy	Color Temp. Renk Sıcaklığı (K)	Luminous Flux Işık Akısı (lm)	Efficacy Etkinlik Faktörü (lm/W)	Dimensions Boyutlar (ØxH)	Package Weight Koli Ağırlığı (kg)	Pcs/Pack Koli Adedi	Price Fiyat
206256	Black/White Siyah/Beyaz	Gu10	-	-	-	120x75	2,25	1	6,95\$
205916	Black/Black Siyah/Siyah	Gu10	-	-	-	120x75	2,25	1	6,95\$
205919	Black/Gold Siyah/Altın	Gu10	-	-	-	120x75	2,25	1	12,40\$
205922	Black/Platin Siyah/Platin	Gu10	-	-	-	120x75	2,25	1	12,40\$
205925	Black/Rose Siyah/Rose	Gu10	-	-	-	120x75	2,25	1	12,40\$

Aluminium Alüminyum IP20 36.000h 2 years / yıl 18° / 24° / 36° Trimless Options Trimless Opsiyonu Semi Recessed Mounted Yarı Gömme Montaj Pendant Mounted Sarkıt Montaj Gu10 Option Gu10 Opsiyonu
Emergency Unit DALI

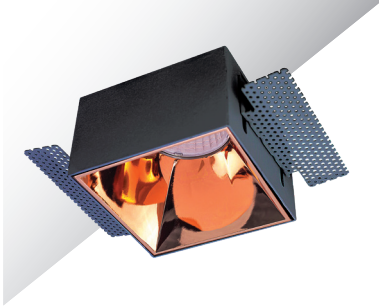

STELLA TRIMLESS (LED)

Code Kod	Body Colour Gövde Rengi	Power Güç (W)	Color Temp. Renk Sıcaklığı (K)	Luminous Flux Işık Akısı (lm)	Efficacy Etkinlik Faktörü (lm/W)	Dimensions Boyutlar (ØxH)	Package Weight Koli Ağırlığı (kg)	Pcs/Pack Koli Adedi	Price Fiyat
209643	Black / White/ Siyah / Beyaz	8	4000	848	106	120x75	2,25	1	43,80\$
209644	Black / White/ Siyah / Beyaz	11	4000	1045	95	120x75	2,25	1	43,80\$
205914	Black Black / Siyah / Siyah	8	4000	848	106	120x75	2,25	1	43,80\$
205915	Black Black / Siyah / Siyah	11	4000	1045	95	120x75	2,25	1	43,80\$
205917	Black / Gold / Siyah / Altın	8	4000	848	106	120x75	2,25	1	50,00\$
205918	Black / Gold / Siyah / Altın	11	4000	1045	95	120x75	2,25	1	50,00\$
205920	Black /Platin / Siyah /Platin	8	4000	848	106	120x75	2,25	1	50,00\$
205921	Black /Platin / Siyah /Platin	11	4000	1045	95	120x75	2,25	1	50,00\$
205923	Black /Rose Siyah /Rose	8	4000	848	106	120x75	2,25	1	50,00\$
205924	Black /Rose Siyah /Rose	11	4000	1045	95	120x75	2,25	1	50,00\$

Aluminium Alüminyum IP20 36.000h 2 years / yıl 18° / 24° / 36° Trimless Options Trimless Opsiyonu Semi Recessed Mounted Yarı Gömme Montaj Pendant Mounted Sarkıt Montaj Gu10 Option Gu10 Opsiyonu
Emergency Unit DALI

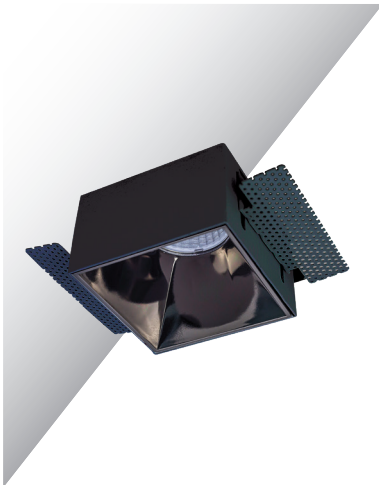



LORA G2 S1

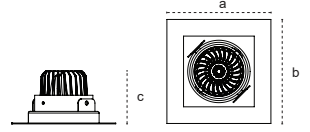

Code Kod	Power Güç (W)	Color Temp. Renk Sıcaklığı (K)	Luminous Flux Işık Akısı (lm)	Efficacy Etkinlik Faktörü (lm/W)	Dimensions Boyutlar (axbxc)	Cut Size Kesim Ölç. (mm)	Package Weight Koli Ağırlığı (kg)	Pcs/Pack Koli Adedi	Price Fiyat
204735	8	3000	824	103	125x125x63	100x100	0,5	1	21,90\$
204753	8	4000	824	103	125x125x63	100x100	0,5	1	21,90\$
204779	8	6500	824	103	125x125x63	100x100	0,5	1	21,90\$
205422	10	3000	1040	104	125x125x63	100x100	0,5	1	23,00\$
205425	10	4000	1040	104	125x125x63	100x100	0,5	1	23,00\$
205438	10	6500	1040	104	125x125x63	100x100	0,5	1	23,00\$

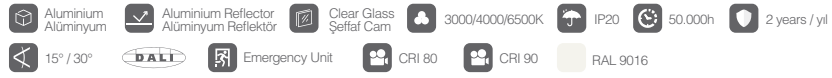

LORA G2 S2

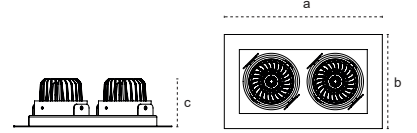

Code Kod	Power Güç (W)	Color Temp. Renk Sıcaklığı (K)	Luminous Flux Işık Akısı (lm)	Efficacy Etkinlik Faktörü (lm/W)	Dimensions Boyutlar (axbxc)	Cut Size Kesim Ölç. (mm)	Package Weight Koli Ağırlığı (kg)	Pcs/Pack Koli Adedi	Price Fiyat
206938	2x10	3000	2100	105	210x125x63,3	190x100	0,825	1	39,70\$
206939	2x10	4000	2100	105	210x125x63,3	190x100	0,825	1	39,70\$
206940	2x10	6500	2100	105	210x125x63,3	190x100	0,825	1	39,70\$

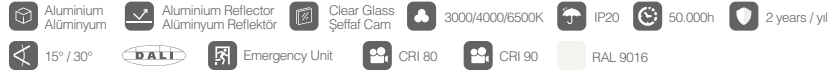

LORA G2 S3

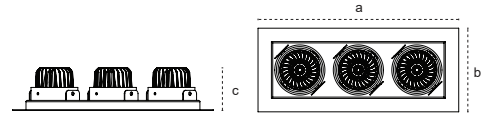

Code Kod	Power Güç (W)	Color Temp. Renk Sıcaklığı (K)	Luminous Flux Işık Akısı (lm)	Efficacy Etkinlik Faktörü (lm/W)	Dimensions Boyutlar (axbxc)	Cut Size Kesim Ölç. (mm)	Package Weight Koli Ağırlığı (kg)	Pcs/Pack Koli Adedi	Price Fiyat
206962	3x8	3000	2568	107	300x125x64	280x100	1,215	1	58,70\$
206963	3x8	4000	2568	107	300x125x64	280x100	1,215	1	58,70\$
206964	3x8	6500	2568	107	300x125x64	280x100	1,215	1	58,70\$
206989	3x10	3000	3180	106	300x125x64	280x100	1,215	1	59,70\$
206990	3x10	4000	3180	106	300x125x64	280x100	1,215	1	59,70\$
206991	3x10	6500	3180	106	300x125x64	280x100	1,215	1	59,70\$

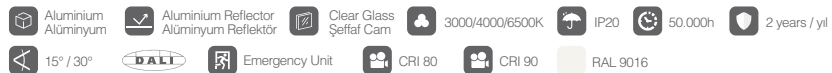

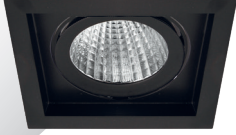

LORA G2 M1

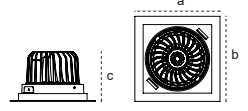

Code Kod	Power Güç (W)	Color Temp. Renk Sıcaklığı (K)	Luminous Flux Işık Akısı (lm)	Efficacy Etkinlik Faktörü (lm/W)	Dimensions Boyutlar (axbxc)	Cut Size Kesim Ölç. (mm)	Package Weight Koli Ağırlığı (kg)	Pcs/Pack Koli Adedi	Price Fiyat
207010	20	3000	2140	107	175x175x102,5	155x155	1,375	1	38,70\$
207011	20	4000	2140	107	175x175x102,5	155x155	1,375	1	38,70\$
207012	20	6500	2140	107	175x175x102,5	155x155	1,375	1	38,70\$
207037	30	3000	3150	105	175x175x102,5	155x155	1,375	1	39,70\$
207038	30	4000	3150	105	175x175x102,5	155x155	1,375	1	39,70\$
207039	30	6500	3150	105	175x175x102,5	155x155	1,375	1	39,70\$

- Aluminium Alüminyum
- Aluminium Reflector Alüminyum Reflektör
- Clear Glass Şeffaf Cam
- 3000/4000/6500K
- IP20
- 50.000h
- 2 years / yıl
- 15° / 30° / 45°
- DALI
- Emergency Unit
- CRI 80
- CRI 90
- RAL 9016



LORA G2 M2

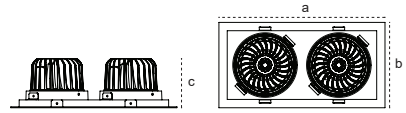

Code Kod	Power Güç (W)	Color Temp. Renk Sıcaklığı (K)	Luminous Flux Işık Akısı (lm)	Efficacy Etkinlik Faktörü (lm/W)	Dimensions Boyutlar (axbxc)	Cut Size Kesim Ölç. (mm)	Package Weight Koli Ağırlığı (kg)	Pcs/Pack Koli Adedi	Price Fiyat
207058	2x20	3000	4280	107	325x175x102,5	305x155	2,705	1	68,60\$
207059	2x20	4000	4280	107	325x175x102,5	305x155	2,705	1	68,60\$
207060	2x20	6500	4280	107	325x175x102,5	305x155	2,705	1	68,60\$
207082	2x30	3000	6300	105	325x175x102,5	305x155	2,705	1	69,60\$
207083	2x30	4000	6300	105	325x175x102,5	305x155	2,705	1	69,60\$
207084	2x30	6500	6300	105	325x175x102,5	305x155	2,705	1	69,60\$

- Aluminium Alüminyum
- Aluminium Reflector Alüminyum Reflektör
- Clear Glass Şeffaf Cam
- 3000/4000/6500K
- IP20
- 50.000h
- 2 years / yıl
- 15° / 30° / 45°
- DALI
- Emergency Unit
- CRI 80
- CRI 90
- RAL 9016



BOE

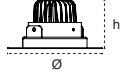

Code Kod	Power Güç (W)	Color Temp. Renk Sıcaklığı (K)	Luminous Flux Işık Akısı (lm)	Efficacy Etkinlik Faktörü (lm/W)	Dimensions Boyutlar (Øxh)	Cut Size Kesim Ölç. (mm)	Package Weight Koli Ağırlığı (kg)	Pcs/Pack Koli Adedi	Price Fiyat
207285	8	3000	680	85	120x63	105	0,31	1	22,00\$
207286	8	4000	680	85	120x63	105	0,31	1	22,00\$
207287	8	6500	680	85	120x63	105	0,31	1	22,00\$

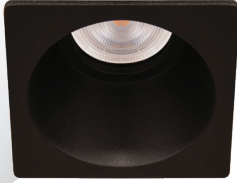
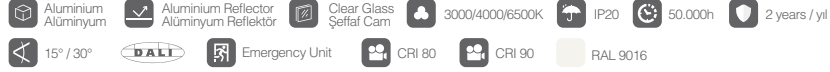

SPICA G3

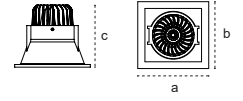

Code Kod	Power Güç (W)	Color Temp. Renk Sıcaklığı (K)	Luminous Flux Işık Akısı (lm)	Efficacy Etkinlik Faktörü (lm/W)	Dimensions Boyutlar (axbxc)	Cut Size Kesim Ölç. (mm)	Package Weight Koli Ağırlığı (kg)	Pcs/Pack Koli Adedi	Price Fiyat
207480	8	3000	664	83	100x100x82	90	0,34	1	20,90\$
207481	8	4000	664	83	100x100x82	90	0,34	1	20,90\$
207482	8	6500	664	83	100x100x82	90	0,34	1	20,90\$

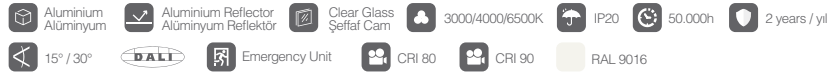

VIRA S1

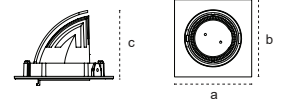

Code Kod	Power Güç (W)	Color Temp. Renk Sıcaklığı (K)	Luminous Flux Işık Akısı (lm)	Efficacy Etkinlik Faktörü (lm/W)	Dimensions Boyutlar (axbxc)	Cut Size Kesim Ölç. (mm)	Package Weight Koli Ağırlığı (kg)	Pcs/Pack Koli Adedi	Price Fiyat
207405	8	3000	720	90	115x115x80	100	0,395	1	27,50\$
207406	8	4000	720	90	115x115x80	100	0,395	1	27,50\$
207407	8	6500	720	90	115x115x80	100	0,395	1	27,50\$

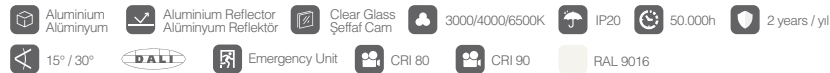

VIRA S2

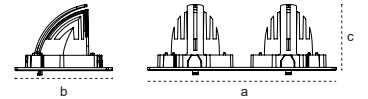

Code Kod	Power Güç (W)	Color Temp. Renk Sıcaklığı (K)	Luminous Flux Işık Akısı (lm)	Efficacy Etkinlik Faktörü (lm/W)	Dimensions Boyutlar (axbxc)	Cut Size Kesim Ölç. (mm)	Package Weight Koli Ağırlığı (kg)	Pcs/Pack Koli Adedi	Price Fiyat
207429	2x8	3000	1440	90	235x115x82	220x100	0,785	1	55,60\$
207430	2x8	4000	1440	90	235x115x82	220x100	0,785	1	55,60\$
207431	2x8	6500	1440	90	235x115x82	220x100	0,785	1	55,60\$
207459	2x10	3000	1774	88	235x115x82	220x100	0,795	1	57,70\$
207460	2x10	4000	1774	88	235x115x82	220x100	0,795	1	57,70\$
207461	2x10	6500	1774	88	235x115x82	220x100	0,795	1	57,70\$

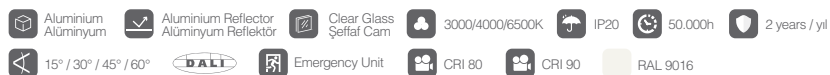



NIRA G2 S

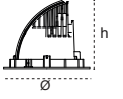

Code Kod	Power Güç (W)	Color Temp. Renk Sıcaklığı (K)	Luminous Flux Işık Akısı (lm)	Efficacy Etkinlik Faktörü (lm/W)	Dimensions Boyutlar (Øxh)	Cut Size Kesim Ölç. (mm)	Package Weight Koli Ağırlığı (kg)	Pcs/Pack Koli Adedi	Price Fiyat
207333	8	3000	880	110	115x85	100	0,38	1	27,00\$
207334	8	4000	880	110	115x85	100	0,38	1	27,00\$
207335	8	6500	880	110	115x85	100	0,38	1	27,00\$

- Aluminium Alüminyum
- Aluminium Reflector Alüminyum Reflektör
- Clear Glass Şeffaf Cam
- 3000/4000/6500K
- IP20
- 50.000h
- 2 years / yıl
- 15° / 30°
- DALI
- Emergency Unit
- CRI 80
- CRI 90
- RAL 9016



NIRA G2 M

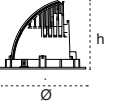

Code Kod	Power Güç (W)	Color Temp. Renk Sıcaklığı (K)	Luminous Flux Işık Akısı (lm)	Efficacy Etkinlik Faktörü (lm/W)	Dimensions Boyutlar (Øxh)	Cut Size Kesim Ölç. (mm)	Package Weight Koli Ağırlığı (kg)	Pcs/Pack Koli Adedi	Price Fiyat
207357	20	3000	2140	107	153x125	145	0,895	1	39,60\$
207358	20	4000	2140	107	153x125	145	0,895	1	39,60\$
207359	20	6500	2140	107	153x125	145	0,895	1	39,60\$
207381	30	3000	3150	105	153x125	145	0,905	1	40,80\$
207382	30	4000	3150	105	153x125	145	0,905	1	40,80\$
207383	30	6500	3150	105	153x125	145	0,905	1	40,80\$

- Aluminium Alüminyum
- Aluminium Reflector Alüminyum Reflektör
- Clear Glass Şeffaf Cam
- 3000/4000/6500K
- IP20
- 50.000h
- 2 years / yıl
- 15° / 30°
- DALI
- Emergency Unit
- CRI 80
- CRI 90
- RAL 9016



NIRA G2 L

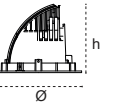

Code Kod	Power Güç (W)	Color Temp. Renk Sıcaklığı (K)	Luminous Flux Işık Akısı (lm)	Efficacy Etkinlik Faktörü (lm/W)	Dimensions Boyutlar (Øxh)	Cut Size Kesim Ölç. (mm)	Package Weight Koli Ağırlığı (kg)	Pcs/Pack Koli Adedi	Price Fiyat
208484	30	3000	3090	103	185x146	170	1,32	1	47,80\$
208485	30	4000	3090	103	185x146	170	1,32	1	47,80\$
208486	30	6500	3090	103	185x146	170	1,32	1	47,80\$
208508	35	3000	3535	101	185x146	170	1,3	1	48,90\$
208509	35	4000	3535	101	185x146	170	1,3	1	48,90\$
208510	35	6500	3535	101	185x146	170	1,3	1	48,90\$

- Aluminium Alüminyum
- Aluminium Reflector Alüminyum Reflektör
- Clear Glass Şeffaf Cam
- 3000/4000/6500K
- IP20
- 50.000h
- 2 years / yıl
- 15° / 30°
- DALI
- Emergency Unit
- CRI 80
- CRI 90
- RAL 9016



VEGA S1

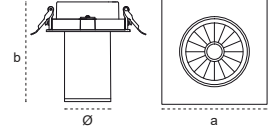

Code Kod	Power Güç (W)	Color Temp. Renk Sıcaklığı (K)	Luminous Flux Işık Akısı (lm)	Efficacy Etkinlik Faktörü (lm/W)	Dimensions Boyutlar (axbxØ)	Cut Size Kesim Ölç. (mm)	Package Weight Koli Ağırlığı (kg)	Pcs/Pack Koli Adedi	Price Fiyat
207777	8	3000	587	73	115x132x60	100	0,42	1	30,30\$
207778	8	4000	587	73	115x132x60	100	0,42	1	30,30\$
207779	8	6500	587	73	115x132x60	100	0,42	1	30,30\$

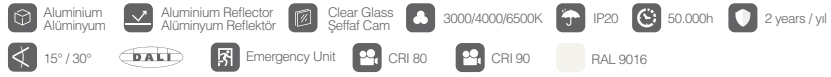

VEGA M1

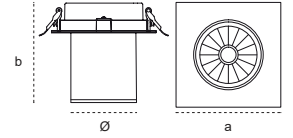

Code Kod	Power Güç (W)	Color Temp. Renk Sıcaklığı (K)	Luminous Flux Işık Akısı (lm)	Efficacy Etkinlik Faktörü (lm/W)	Dimensions Boyutlar (axbxØ)	Cut Size Kesim Ölç. (mm)	Package Weight Koli Ağırlığı (kg)	Pcs/Pack Koli Adedi	Price Fiyat
207825	15	3000	1242	82	140x145x85	120	1,09	1	39,60\$
207826	15	4000	1242	82	140x145x85	120	1,09	1	39,60\$
207827	15	6500	1242	82	140x145x85	120	1,09	1	39,60\$
207831	20	3000	1774	88	140x145x85	120	1,09	1	40,80\$
207832	20	4000	1774	88	140x145x85	120	1,09	1	40,80\$
207833	20	6500	1774	88	140x145x85	120	1,09	1	40,80\$

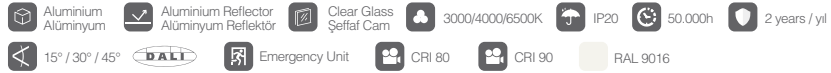

VEGA L1

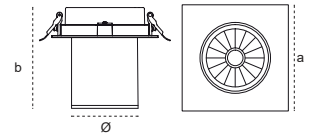

Code Kod	Power Güç (W)	Color Temp. Renk Sıcaklığı (K)	Luminous Flux Işık Akısı (lm)	Efficacy Etkinlik Faktörü (lm/W)	Dimensions Boyutlar (axbxØ)	Cut Size Kesim Ölç. (mm)	Package Weight Koli Ağırlığı (kg)	Pcs/Pack Koli Adedi	Price Fiyat
207873	30	3000	2938	97	160x145x100	145	1,09	1	44,00\$
207874	30	4000	2938	97	160x145x100	145	1,09	1	44,00\$
207875	30	6500	2938	97	160x145x100	145	1,09	1	44,00\$
207879	35	3000	3256	93	160x145x100	145	1,1	1	45,10\$
207880	35	4000	3256	93	160x145x100	145	1,1	1	45,10\$
207881	35	6500	3256	93	160x145x100	145	1,1	1	45,10\$

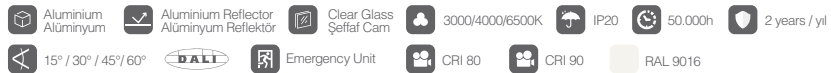



VEGA S2

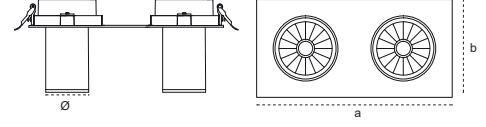

Code Kod	Power Güç (W)	Color Temp. Renk Sıcaklığı (K)	Luminous Flux Işık Akısı (lm)	Efficacy Etkinlik Faktörü (lm/W)	Dimensions Boyutlar (axbxØ)	Cut Size Kesim Ölç. (mm)	Package Weight Koli Ağırlığı (kg)	Pcs/Pack Koli Adedi	Price Fiyat
207801	2x8	3000	1440	90	230x132x60	215x100	0,84	1	57,30\$
207802	2x8	4000	1440	90	230x132x60	215x100	0,84	1	57,30\$
207803	2x8	6500	1440	90	230x132x60	215x100	0,84	1	57,30\$
207807	2x10	3000	1774	88	230x132x60	215x100	0,85	1	58,30\$
207808	2x10	4000	1774	88	230x132x60	215x100	0,85	1	58,30\$
207809	2x10	6500	1774	88	230x132x60	215x100	0,85	1	58,30\$

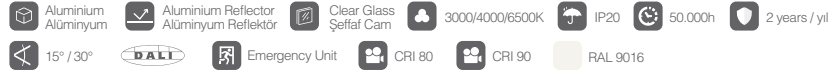

VEGA M2

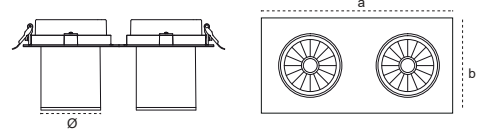

Code Kod	Power Güç (W)	Color Temp. Renk Sıcaklığı (K)	Luminous Flux Işık Akısı (lm)	Efficacy Etkinlik Faktörü (lm/W)	Dimensions Boyutlar (axbxØ)	Cut Size Kesim Ölç. (mm)	Package Weight Koli Ağırlığı (kg)	Pcs/Pack Koli Adedi	Price Fiyat
207849	2x15	3000	2530	84	280x140x145	265X120	1,91	1	80,50\$
207850	2x15	4000	2530	84	280x140x145	265X120	1,91	1	80,50\$
207851	2x15	6500	2530	84	280x140x145	265X120	1,91	1	80,50\$
207855	2x20	3000	3537	88	280x140x145	265X120	1,91	1	81,30\$
207856	2x20	4000	3537	88	280x140x145	265X120	1,91	1	81,30\$
207857	2x20	6500	3537	88	280x140x145	265X120	1,91	1	81,30\$

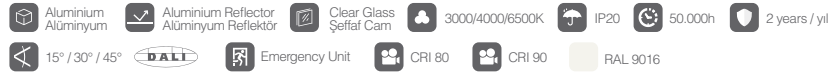

VEGA L2

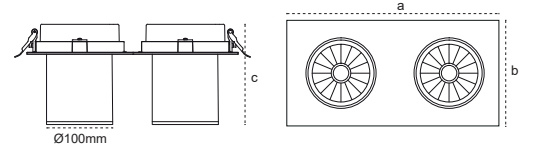

Code Kod	Power Güç (W)	Color Temp. Renk Sıcaklığı (K)	Luminous Flux Işık Akısı (lm)	Efficacy Etkinlik Faktörü (lm/W)	Dimensions Boyutlar (axbxØ)	Cut Size Kesim Ölç. (mm)	Package Weight Koli Ağırlığı (kg)	Pcs/Pack Koli Adedi	Price Fiyat
207885	2x30	3000	6000	100	318x160x145	295x145	2,18	1	85,70\$
207886	2x30	4000	6000	100	318x160x145	295x145	2,18	1	85,70\$
207887	2x30	6500	6000	100	318x160x145	295x145	2,18	1	85,70\$
207891	2x35	3000	6512	93	318x160x145	295x145	2,19	1	86,70\$
207892	2x35	4000	6512	93	318x160x145	295x145	2,19	1	86,70\$
207893	2x35	6500	6512	93	318x160x145	295x145	2,19	1	86,70\$

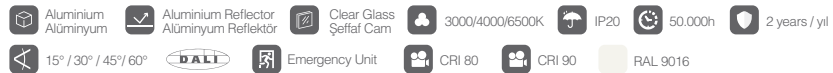

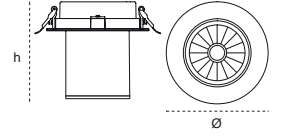

TERRA

Code Kod	Power Güç (W)	Color Temp. Renk Sıcaklığı (K)	Luminous Flux Işık Akısı (lm)	Efficacy Etkinlik Faktörü (lm/W)	Dimensions Boyutlar (Øxh)	Cut Size Kesim Ölç. (mm)	Package Weight Koli Ağırlığı (kg)	Pcs/Pack Koli Adedi	Price Fiyat
207705	15	3000	1605	107	140x145	120	0,95	1	40,10\$
207706	15	4000	1605	107	140x145	120	0,95	1	40,10\$
207707	15	6500	1605	107	140x145	120	0,95	1	40,10\$
207717	20	3000	2120	106	140x145	120	0,95	1	41,10\$
207718	20	4000	2120	106	140x145	120	0,95	1	41,10\$
207719	20	6500	2120	106	140x145	120	0,95	1	41,10\$

- Aluminium Alüminyum
- Aluminium Reflector Alüminyum Reflektör
- Clear Glass Şeffaf Cam
- 3000/4000/6500K
- IP20
- 50.000h
- 2 years / yıl
- 15° / 30° / 45°
- DALI
- Emergency Unit
- CRI 80
- CRI 90
- RAL 9016

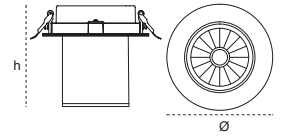

TERRA

Code Kod	Power Güç (W)	Color Temp. Renk Sıcaklığı (K)	Luminous Flux Işık Akısı (lm)	Efficacy Etkinlik Faktörü (lm/W)	Dimensions Boyutlar (Øxh)	Cut Size Kesim Ölç. (mm)	Package Weight Koli Ağırlığı (kg)	Pcs/Pack Koli Adedi	Price Fiyat
207753	30	3000	3180	106	155x145	145	1,09	1	44,10\$
207754	30	4000	3180	106	155x145	145	1,09	1	44,10\$
207755	30	6500	3180	106	155x145	145	1,09	1	44,10\$
207759	35	3000	3640	104	155x145	145	1,1	1	45,20\$
207760	35	4000	3640	104	155x145	145	1,1	1	45,20\$
207761	35	6500	3640	104	155x145	145	1,1	1	45,20\$

- Aluminium Alüminyum
- Aluminium Reflector Alüminyum Reflektör
- Clear Glass Şeffaf Cam
- 3000/4000/6500K
- IP20
- 50.000h
- 2 years / yıl
- 15° / 30° / 45° / 60°
- DALI
- Emergency Unit
- CRI 80
- CRI 90
- RAL 9016



 **recta**
a r t a n d l i g h t

SURFACE MOUNTED SPOT LUMINAIRES
SIVA ÜSTÜ SPOT ARMATÜRLER



TALIA S1

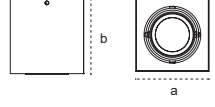

Code Kod	Power Güç (W)	Color Temp. Renk Sıcaklığı (K)	Luminous Flux Işık Akısı (lm)	Efficacy Etkinlik Faktörü (lm/W)	Dimensions Boyutlar (axb)	Package Weight Koli Ağırlığı (kg)	Pcs/Pack Koli Adedi	Price Fiyat
207921	8	3000	832	104	100x100	0,64	1	27,50\$
207922	8	4000	832	104	100x100	0,64	1	27,50\$
207923	8	6500	832	104	100x100	0,64	1	27,50\$

- Aluminium Alüminyum
- Aluminium Reflector Alüminyum Reflektör
- Clear Glass Şeffaf Cam
- 3000/4000/6500K
- IP20
- 50.000h
- 2 years / yıl
- 15° / 30°
- DALI
- Emergency Unit
- CRI 80
- CRI 90
- RAL 9016



TALIA S2

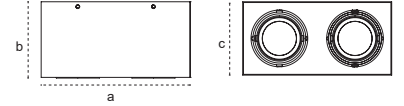

Code Kod	Power Güç (W)	Color Temp. Renk Sıcaklığı (K)	Luminous Flux Işık Akısı (lm)	Efficacy Etkinlik Faktörü (lm/W)	Dimensions Boyutlar (axbxc)	Package Weight Koli Ağırlığı (kg)	Pcs/Pack Koli Adedi	Price Fiyat
207927	2x8	3000	1680	105	200x100x100	1,29	1	46,30\$
207928	2x8	4000	1680	105	200x100x100	1,29	1	46,30\$
207929	2x8	6500	1680	105	200x100x100	1,29	1	46,30\$
207933	2x10	3000	2080	104	200x100x100	1,3	1	47,30\$
207934	2x10	4000	2080	104	200x100x100	1,3	1	47,30\$
207935	2x10	6500	2080	104	200x100x100	1,3	1	47,30\$

- Aluminium Alüminyum
- Aluminium Reflector Alüminyum Reflektör
- Clear Glass Şeffaf Cam
- 3000/4000/6500K
- IP20
- 50.000h
- 2 years / yıl
- 15° / 30°
- DALI
- Emergency Unit
- CRI 80
- CRI 90
- RAL 9016



TALIA S3

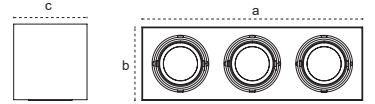

Code Kod	Power Güç (W)	Color Temp. Renk Sıcaklığı (K)	Luminous Flux Işık Akısı (lm)	Efficacy Etkinlik Faktörü (lm/W)	Dimensions Boyutlar (axbxc)	Package Weight Koli Ağırlığı (kg)	Pcs/Pack Koli Adedi	Price Fiyat
207939	3x8	3000	2448	102	292x100x100	1,95	1	66,20\$
207940	3x8	4000	2448	102	292x100x100	1,95	1	66,20\$
207941	3x8	6500	2448	102	292x100x100	1,95	1	66,20\$

- Aluminium Alüminyum
- Aluminium Reflector Alüminyum Reflektör
- Clear Glass Şeffaf Cam
- 3000/4000/6500K
- IP20
- 50.000h
- 2 years / yıl
- 15° / 30°
- DALI
- Emergency Unit
- CRI 80
- CRI 90
- RAL 9016



TALIA M1

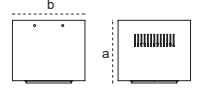

Code Kod	Power Güç (W)	Color Temp. Renk Sıcaklığı (K)	Luminous Flux Işık Akısı (lm)	Efficacy Etkinlik Faktörü (lm/W)	Dimensions Boyutlar (axb)	Package Weight Koli Ağırlığı (kg)	Pcs/Pack Koli Adedi	Price Fiyat
207969	30	3000	3060	102	140x140	1,4	1	45,30\$
207970	30	4000	3060	102	140x140	1,4	1	45,30\$
207971	30	6500	3060	102	140x140	1,4	1	45,30\$



TALIA M2

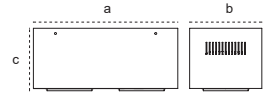

Code Kod	Power Güç (W)	Color Temp. Renk Sıcaklığı (K)	Luminous Flux Işık Akısı (lm)	Efficacy Etkinlik Faktörü (lm/W)	Dimensions Boyutlar (axbxc)	Package Weight Koli Ağırlığı (kg)	Pcs/Pack Koli Adedi	Price Fiyat
207981	2X30	3000	6000	100	280x140x140	3,2	1	83,30\$
207982	2X30	4000	6000	100	280x140x140	3,2	1	83,30\$
207983	2X30	6500	6000	100	280x140x140	3,2	1	83,30\$



TALIA L1

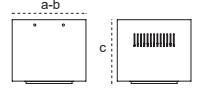

Code Kod	Power Güç (W)	Color Temp. Renk Sıcaklığı (K)	Luminous Flux Işık Akısı (lm)	Efficacy Etkinlik Faktörü (lm/W)	Dimensions Boyutlar (axbxc)	Package Weight Koli Ağırlığı (kg)	Pcs/Pack Koli Adedi	Price Fiyat
208017	30	3000	3210	107	160x160x150	2,05	1	47,40\$
208018	30	4000	3210	107	160x160x150	2,05	1	47,40\$
208019	30	6500	3210	107	160x160x150	2,05	1	47,40\$
208023	35	3000	3675	105	160x160x150	2,06	1	48,50\$
208024	35	4000	3675	105	160x160x150	2,06	1	48,50\$
208025	35	6500	3675	105	160x160x150	2,06	1	48,50\$

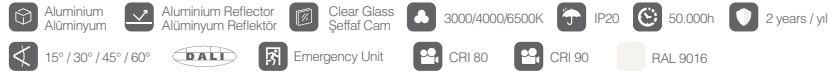

TALIA L2

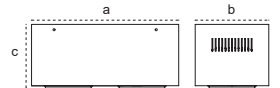

Code Kod	Power Güç (W)	Color Temp. Renk Sıcaklığı (K)	Luminous Flux Işık Akısı (lm)	Efficacy Etkinlik Faktörü (lm/W)	Dimensions Boyutlar (axbxc)	Package Weight Koli Ağırlığı (kg)	Pcs/Pack Koli Adedi	Price Fiyat
208041	2X30	3000	6060	101	320x160x150	4,39	1	84,90\$
208042	2X30	4000	6060	101	320x160x150	4,39	1	84,90\$
208043	2X30	6500	6060	101	320x160x150	4,39	1	84,90\$
208047	2x35	3000	7140	102	320x160x150	4,4	1	86,00\$
208048	2x35	4000	7140	102	320x160x150	4,4	1	86,00\$
208049	2x35	6500	7140	102	320x160x150	4,4	1	86,00\$

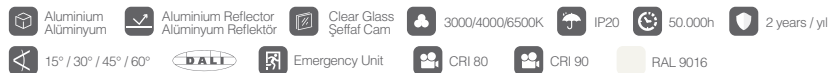

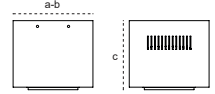

TALIA XL1



Code Kod	Power Güç (W)	Color Temp. Renk Sıcaklığı (K)	Luminous Flux Işık Akısı (lm)	Efficacy Etkinlik Faktörü (lm/W)	Dimensions Boyutlar (axbxc)	Package Weight Koli Ağırlığı (kg)	Pcs/Pack Koli Adedi	Price Fiyat
208065	30	3000	3150	105	180x180x150	2,475	1	56,20\$
208066	30	4000	3150	105	180x180x150	2,475	1	56,20\$
208067	30	6500	3150	105	180x180x150	2,475	1	56,20\$
208071	35	3000	3640	104	180x180x150	2,485	1	57,20\$
208072	35	4000	3640	104	180x180x150	2,485	1	57,20\$
208073	35	6500	3640	104	180x180x150	2,485	1	57,20\$

- Aluminium Alüminyum
- Aluminium Reflector Alüminyum Reflektör
- Clear Glass Şeffaf Cam
- 3000/4000/6500K
- IP20
- 50.000h
- 2 years / yıl
- 15° / 30° / 45° / 60°
- DALI
- Emergency Unit
- CRI 80
- CRI 90
- RAL 9016

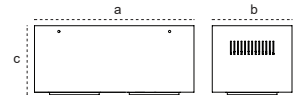

TALIA XL2



Code Kod	Power Güç (W)	Color Temp. Renk Sıcaklığı (K)	Luminous Flux Işık Akısı (lm)	Efficacy Etkinlik Faktörü (lm/W)	Dimensions Boyutlar (axbxc)	Package Weight Koli Ağırlığı (kg)	Pcs/Pack Koli Adedi	Price Fiyat
208077	2X30	3000	6300	105	360x180x150	4,96	1	102,60\$
208078	2X30	4000	6300	105	360x180x150	4,96	1	102,60\$
208079	2X30	6500	6300	105	360x180x150	4,96	1	102,60\$
208083	2x35	3000	7280	104	360x180x150	4,97	1	103,60\$
208084	2x35	4000	7280	104	360x180x150	4,97	1	103,60\$
208085	2x35	6500	7280	104	360x180x150	4,97	1	103,60\$

- Aluminium Alüminyum
- Aluminium Reflector Alüminyum Reflektör
- Clear Glass Şeffaf Cam
- 3000/4000/6500K
- IP20
- 50.000h
- 2 years / yıl
- 15° / 30° / 45° / 60°
- DALI
- Emergency Unit
- CRI 80
- CRI 90
- RAL 9016

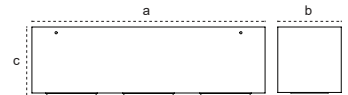

TALIA XL3



Code Kod	Power Güç (W)	Color Temp. Renk Sıcaklığı (K)	Luminous Flux Işık Akısı (lm)	Efficacy Etkinlik Faktörü (lm/W)	Dimensions Boyutlar (axbxc)	Package Weight Koli Ağırlığı (kg)	Pcs/Pack Koli Adedi	Price Fiyat
208089	3x30	3000	9450	105	530x180x150	7,44	1	152,80\$
208090	3x30	4000	9450	105	530x180x150	7,44	1	152,80\$
208091	3x30	6500	9450	105	530x180x150	7,44	1	152,80\$
208095	3x35	3000	10815	103	530x180x150	7,45	1	153,80\$
208096	3x35	4000	10815	103	530x180x150	7,45	1	153,80\$
208097	3x35	6500	10815	103	530x180x150	7,45	1	153,80\$

- Aluminium Alüminyum
- Aluminium Reflector Alüminyum Reflektör
- Clear Glass Şeffaf Cam
- 3000/4000/6500K
- IP20
- 50.000h
- 2 years / yıl
- 15° / 30° / 45° / 60°
- DALI
- Emergency Unit
- CRI 80
- CRI 90
- RAL 9016



 **recta**
a r t a n d l i g h t

TRACK SPOT LUMINAIRES
RAY SPOT ARMATÜRLER



THETA

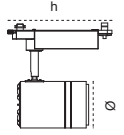

Code Kod	Power Güç (W)	Color Temp. Renk Sıcaklığı (K)	Luminous Flux Işık Akısı (lm)	Efficacy Etkinlik Faktörü (lm/W)	Dimensions Boyutlar (Øxh)	Package Weight Koli Ağırlığı (kg)	Pcs/Pack Koli Adedi	Price Fiyat
113753	30	3000	2400	80	100x230	9,5	16	26,90\$
114371	30	4000	2400	80	100x230	9,5	16	26,90\$

Aluminium Alüminyum	Aluminium Reflector Alüminyum Reflektör	3000/4000/6500K	IP20	50.000h	2 years / yil
75°	CRI 80	Monophese Monofaz			



ZETA G2

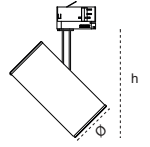

Code Kod	Power Güç (W)	Color Temp. Renk Sıcaklığı (K)	Luminous Flux Işık Akısı (lm)	Efficacy Etkinlik Faktörü (lm/W)	Dimensions Boyutlar (Øxh)	Package Weight Koli Ağırlığı (kg)	Pcs/Pack Koli Adedi	Price Fiyat
207234	20	3000	2100	105	85x195	1,05	1	39,70\$
207235	20	4000	2100	105	85x195	1,05	1	39,70\$
207236	20	6500	2100	105	85x195	1,05	1	39,70\$
207258	30	3000	3090	103	85x195	1,05	1	42,80\$
207259	30	4000	3090	103	85x195	1,05	1	42,80\$
207260	30	6500	3090	103	85x195	1,05	1	42,80\$

Aluminium Alüminyum	Aluminium Reflector Alüminyum Reflektör	Clear Glass Şeffaf Cam	3000/4000/6500K	IP20	50.000h	2 years / yil	
15° / 30° / 45°	DALI	Emergency Unit	CRI 80	CRI 90	RAL 9016	Monophese Monofaz	Threphese Trifaz



OMEGA G2

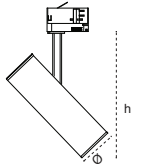

Code Kod	Lampholder Duy	Color Temp. Renk Sıcaklığı (K)	Luminous Flux Işık Akısı (lm)	Efficacy Etkinlik Faktörü (lm/W)	Dimensions Boyutlar (Øxh)	Package Weight Koli Ağırlığı (kg)	Pcs/Pack Koli Adedi	Price Fiyat
207233	Gu10	-	-	-	60x120	0,25	1	11,10\$

Aluminium Alüminyum	Aluminium Reflector Alüminyum Reflektör	3000/4000/6500K	IP20	2 years / yil
35°	RAL 9005	Monophese Monofaz	Threphese Trifaz	



Code Kod	Features Özellikler	Pcs/Pack Koli Adedi	Price Fiyat
303845	Monophase Rail 1 Meter Black / Tek Fazlı Ray 1 Metre Siyah	1	7,75\$
303846	Monophase Rail 2 Meters Black / Tek Fazlı Ray 2 Metre Siyah	1	15,20\$
303847	Monophase Rail 3 Meters Black / Tek Fazlı Ray 3 Metre Siyah	1	22,70\$
303848	Monophase Rail L Connector Black / Tek Fazlı Ray L Bağlantı Parçası Siyah	1	4,10\$
303849	Monophase Rail T Connector Black / Tek Fazlı Ray T Bağlantı Parçası Siyah	1	6,30\$
316066	Monophase Rail X Connector Black / Tek Fazlı Ray X Bağlantı Parçası Siyah	1	7,05\$
303835	Monophase Rail I Connector Black / Tek Fazlı Ray I Bağlantı Parçası Siyah	1	3,30\$
316067	Monophase Rail End Piece -Black / Tek Fazlı Ray Son Parça Siyah	1	3,40\$

Code Kod	Features Özellikler	Pcs/Pack Koli Adedi	Price Fiyat
303833	Three Phase Rail 1 Meter Black / Trifaze Ray 1 Metre Siyah	1	17,70\$
303832	Three Phase Rail 2 Meter Black / Trifaze Ray 2 Metre Siyah	1	35,40\$
303831	Three Phase Rail 3 Meter Black / Trifaze Ray 3 Metre Siyah	1	53,05\$
328945	Three Phase Rail L Connector Black / Trifaze Ray L Bağlantı Parçası Siyah	1	10,00\$
303829	Three Phase Rail T Connector Black / Trifaze Ray T Bağlantı Parçası Siyah	1	14,50\$
328958	Three Phase Rail X Connector Black / Trifaze Ray X Bağlantı Parçası Siyah	1	22,75\$
303830	Three Phase Rail I Connector Black / Trifaze Ray I Bağlantı Parçası Siyah	1	3,80\$
303828	Three Phase Rail End Piece - Black / Trifaze Ray Son Parça - Siyah	1	4,85\$



LAMEC S

Code Kod	Power Güç (W)	Color Temp. Renk Sıcaklığı (K)	Luminous Flux Işık Akısı (lm)	Efficacy Etkinlik Faktörü (lm/W)	Dimensions Boyutlar (Øxh)	Package Weight Koli Ağırlığı (kg)	Pcs/Pack Koli Adedi	Price Fiyat
208636	15	3000	1350	90	85x124	0,76	1	42,90\$
208635	15	4000	1350	90	85x124	0,76	1	42,90\$
208634	15	6500	1350	90	85x124	0,76	1	42,90\$
208633	20	3000	1800	90	85x124	0,77	1	43,90\$
208632	20	4000	1800	90	85x124	0,77	1	43,90\$
208631	20	6500	1800	90	85x124	0,77	1	43,90\$

Aluminium Alüminyum Aluminium Reflector Alüminyum Reflektör Clear Glass Şeffaf Cam 3000/4000/6500K IP20 50.000h 2 years / yıl
15° / 30° / 45° DALI Emergency Unit CRI 80 CRI 90 RAL 9016 Monophese Monofaz Threphese Trifaz

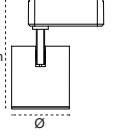

LAMEC M

Code Kod	Power Güç (W)	Color Temp. Renk Sıcaklığı (K)	Luminous Flux Işık Akısı (lm)	Efficacy Etkinlik Faktörü (lm/W)	Dimensions Boyutlar (Øxh)	Package Weight Koli Ağırlığı (kg)	Pcs/Pack Koli Adedi	Price Fiyat
208627	20	3000	1800	90	100x185	1	1	46,00\$
208626	20	4000	1800	90	100x185	1	1	46,00\$
208625	20	6500	1800	90	100x185	1	1	46,00\$
208630	30	3000	2790	93	100x185	1,1	1	47,00\$
208629	30	4000	2790	93	100x185	1,1	1	47,00\$
208628	30	6500	2790	93	100x185	1,1	1	47,00\$

Aluminium Alüminyum Aluminium Reflector Alüminyum Reflektör Clear Glass Şeffaf Cam 3000/4000/6500K IP20 50.000h 2 years / yıl
15° / 30° / 45° / 60° DALI Emergency Unit CRI 80 CRI 90 RAL 9016 Monophese Monofaz Threphese Trifaz

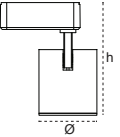

VIAR S

Code Kod	Power Güç (W)	Color Temp. Renk Sıcaklığı (K)	Luminous Flux Işık Akısı (lm)	Efficacy Etkinlik Faktörü (lm/W)	Dimensions Boyutlar (Øxh)	Package Weight Koli Ağırlığı (kg)	Pcs/Pack Koli Adedi	Price Fiyat
208612	15	3000	1350	90	85x104	0,67	1	49,20\$
208611	15	4000	1350	90	85x104	0,67	1	49,20\$
208610	15	6500	1350	90	85x104	0,67	1	49,20\$
208609	20	3000	1800	90	85x104	0,68	1	50,20\$
208608	20	4000	1800	90	85x104	0,68	1	50,20\$
208607	20	6500	1800	90	85x104	0,68	1	50,20\$

Aluminium Alüminyum Aluminium Reflector Alüminyum Reflektör Clear Glass Şeffaf Cam 3000/4000/6500K IP20 50.000h 2 years / yıl
15° / 30° / 45° DALI Emergency Unit CRI 80 CRI 90 RAL 9016 Monophese Monofaz Threphese Trifaz

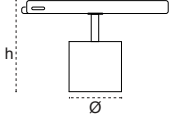

VIAR M

Code Kod	Power Güç (W)	Color Temp. Renk Sıcaklığı (K)	Luminous Flux Işık Akısı (lm)	Efficacy Etkinlik Faktörü (lm/W)	Dimensions Boyutlar (Øxh)	Package Weight Koli Ağırlığı (kg)	Pcs/Pack Koli Adedi	Price Fiyat
208606	20	3000	1800	90	100x98	0,86	1	52,00\$
208605	20	4000	1800	90	100x98	0,86	1	52,00\$
208604	20	6500	1800	90	100x98	0,86	1	52,00\$
208603	30	3000	2790	93	100x98	0,87	1	54,00\$
208602	30	4000	2790	93	100x98	0,87	1	54,00\$
208601	30	6500	2790	93	100x98	0,87	1	54,00\$

Aluminium Alüminyum Aluminium Reflector Alüminyum Reflektör Clear Glass Şeffaf Cam 3000/4000/6500K IP20 50.000h 2 years / yıl
15° / 30° / 45° / 60° DALI Emergency Unit CRI 80 CRI 90 RAL 9016 Monophese Monofaz Threphese Trifaz

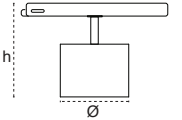



CANVIO S

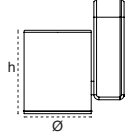

Code Kod	Power Güç (W)	Color Temp. Renk Sıcaklığı (K)	Luminous Flux Işık Akısı (lm)	Efficacy Etkinlik Faktörü (lm/W)	Dimensions Boyutlar (Øxh)	Package Weight Koli Ağırlığı (kg)	Pcs/Pack Koli Adedi	Price Fiyat
208624	15	3000	1350	90	85x109	0,9	1	45,90\$
208623	15	4000	1350	90	85x109	0,9	1	45,90\$
208622	15	6500	1350	90	85x109	0,9	1	45,90\$
208619	20	3000	1800	90	85x109	1	1	46,90\$
208620	20	4000	1800	90	85x109	1	1	46,90\$
208621	20	6500	1800	90	85x109	1	1	46,90\$

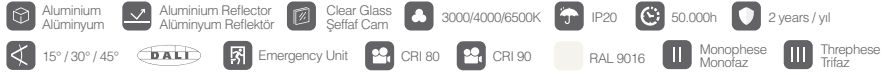

CANVIO M

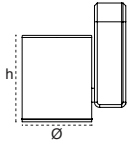

Code Kod	Power Güç (W)	Color Temp. Renk Sıcaklığı (K)	Luminous Flux Işık Akısı (lm)	Efficacy Etkinlik Faktörü (lm/W)	Dimensions Boyutlar (Øxh)	Package Weight Koli Ağırlığı (kg)	Pcs/Pack Koli Adedi	Price Fiyat
208618	20	3000	1800	90	100x113	1	1	49,50\$
208617	20	4000	1800	90	100x113	1	1	49,50\$
208616	20	6500	1800	90	100x113	1	1	49,50\$
208615	30	3000	2790	93	100x113	1,05	1	50,50\$
208614	30	4000	2790	93	100x113	1,05	1	50,50\$
208613	30	6500	2790	93	100x113	1,05	1	50,50\$



NOBI

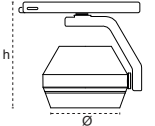

Code Kod	Power Güç (W)	Color Temp. Renk Sıcaklığı (K)	Luminous Flux Işık Akısı (lm)	Efficacy Etkinlik Faktörü (lm/W)	Dimensions Boyutlar (Øxh)	Package Weight Koli Ağırlığı (kg)	Pcs/Pack Koli Adedi	Price Fiyat
208639	20	3000	1860	93	90x137	1,77	1	52,80\$
208638	20	4000	1860	93	90x137	1,77	1	52,80\$
208637	20	6500	1860	93	90x137	1,77	1	52,80\$
208642	30	3000	2940	98	90x137	2,93	1	53,80\$
208641	30	4000	2940	98	90x137	2,93	1	53,80\$
208640	30	6500	2940	98	90x137	2,93	1	53,80\$



Code Kod	Features Özellikler	Pcs/Pack Koli Adedi	Price Fiyat
303839	Monophase Rail 1 Meter White / Tek Fazlı Ray 1 Metre Beyaz	1	7,75\$
303840	Monophase Rail 2 Meters White / Tek Fazlı Ray 2 Metre Beyaz	1	15,20\$
303841	Monophase Rail 3 Meters White / Tek Fazlı Ray 3 Metre Beyaz	1	22,70\$
303842	Monophase Rail L Connector White / Tek Fazlı Ray L Bağlantı Parçası Beyaz	1	4,10\$
303843	Monophase Rail T Connector White / Tek Fazlı Ray T Bağlantı Parçası Beyaz	1	6,30\$
316068	Monophase Rail X Connector White / Tek Fazlı Ray X Bağlantı Parçası Beyaz	1	7,05\$
303844	Monophase Rail I Connector White / Tek Fazlı Ray I Bağlantı Parçası Beyaz	1	3,30\$
316069	Monophase Rail End Piece -White / Tek Fazlı Ray Son Parça Beyaz	1	3,40\$

Code Kod	Features Özellikler	Pcs/Pack Koli Adedi	Price Fiyat
328054	Three Phase Rail 1 Meter White / Trifaze Ray 1 Metre Beyaz	1	17,70\$
328056	Three Phase Rail 2 Meter White / Trifaze Ray 2 Metre Beyaz	1	35,40\$
328059	Three Phase Rail 3 Meter White / Trifaze Ray 3 Metre Beyaz	1	53,05\$
328959	Three Phase Rail L Connector White / Trifaze Ray L Bağlantı Parçası Beyaz	1	10,00\$
328960	Three Phase Rail T Connector White / Trifaze Ray T Bağlantı Parçası Beyaz	1	14,50\$
328961	Three Phase Rail X Connector White / Trifaze Ray X Bağlantı Parçası Beyaz	1	22,75\$
328055	Three Phase Rail I Connector White / Trifaze Ray I Bağlantı Parçası Beyaz	1	3,80\$
328057	Three Phase Rail End Piece - White / Trifaze Ray Son Parça - Beyaz	1	4,85\$

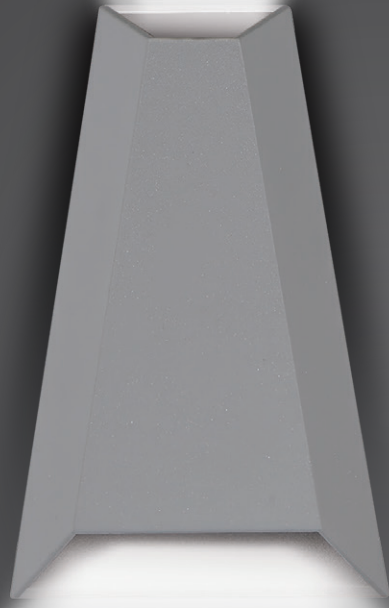

 **recta**
a r t a n d l i g h t

INDOOR & OUTDOOR APPLIQUES
İÇ & DIŞ MEKAN APLİKLER

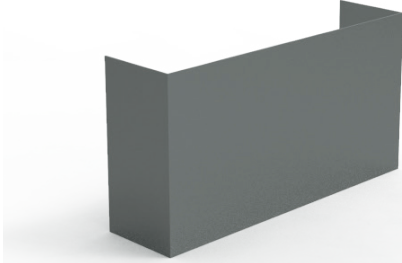

LANDI

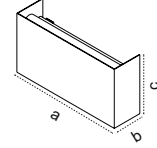

Code Kod	Power Güç (W)	Color Temp. Renk Sıcaklığı (K)	Luminous Flux Işık Akısı (lm)	Efficacy Etkinlik Faktörü (lm/W)	Dimensions Boyutlar (axbxc)	Package Weight Koli Ağırlığı (kg)	Pcs/Pack Koli Adedi	Price Fiyat
109763	7	4000	595	85	175x90x50	9,6	12	41,70\$

Metal
 PMMA
 IP20
 IK06
 30.000h
 2 years



QUINN

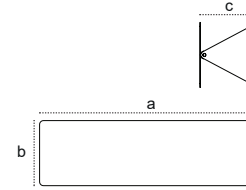

Code Kod	Power Güç (W)	Color Temp. Renk Sıcaklığı (K)	Luminous Flux Işık Akısı (lm)	Efficacy Etkinlik Faktörü (lm/W)	Dimensions Boyutlar (axbxc)	Package Weight Koli Ağırlığı (kg)	Pcs/Pack Koli Adedi	Price Fiyat
111389	10	4000	850	85	330x100x80	9,6	12	42,60\$

Metal
 PMMA
 IP20
 IK06
 30.000h
 2 years

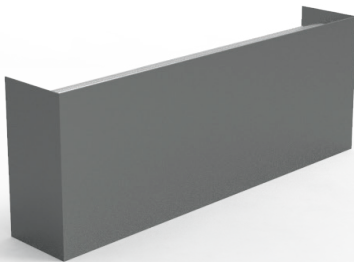

DIAZ

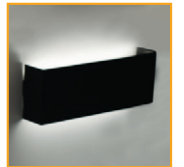
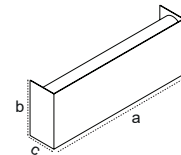

Code Kod	Power Güç (W)	Color Temp. Renk Sıcaklığı (K)	Luminous Flux Işık Akısı (lm)	Efficacy Etkinlik Faktörü (lm/W)	Dimensions Boyutlar (axbxc)	Package Weight Koli Ağırlığı (kg)	Pcs/Pack Koli Adedi	Price Fiyat
111391	10	4000	850	85	300x110x45	7,2	12	47,70\$

Metal
 PMMA
 IP20
 IK06
 30.000h
 2 years

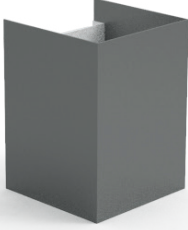

LORCA UP / DOWN

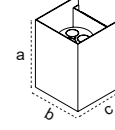

Code Kod	Type Tip	Base Duy	Luminous Flux Işık Akısı (lm)	Efficacy Etkinlik Faktörü (lm/W)	Dimensions Boyutlar (axbxc)	Package Weight Koli Ağırlığı (kg)	Pcs/Pack Koli Adedi	Price Fiyat
111118	Lorca Up	1XGu10	-	-	90x65x65	6,5	12	9,80\$
113081	Lorca Down	1XGu10	-	-	90x65x65	5,88	12	9,80\$

Metal IP20 IK06 2 years



RODIN

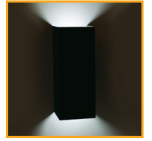
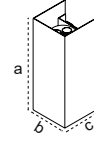

Code Kod	Base Duy	Color Temp. Renk Sıcaklığı (K)	Luminous Flux Işık Akısı (lm)	Efficacy Etkinlik Faktörü (lm/W)	Dimensions Boyutlar (axbxc)	Package Weight Koli Ağırlığı (kg)	Pcs/Pack Koli Adedi	Price Fiyat
111116	2xGu10	-	-	-	165x65x65	8,28	12	11,40\$

Metal IP20 IK06 2 years



VOGEL

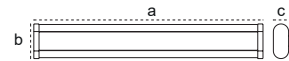

Code Kod	Power Güç (W)	Color Temp. Renk Sıcaklığı (K)	Luminous Flux Işık Akısı (lm)	Efficacy Etkinlik Faktörü (lm/W)	Dimensions Boyutlar (axbxc)	Package Weight Koli Ağırlığı (kg)	Pcs/Pack Koli Adedi	Price Fiyat
109541	20	4000	1700	85	650x100x70	26	10	46,30\$
109542	2X9	6500	1530	85	650x100x70	26	10	21,00\$

Metal Opal IP20 IK06 50.000h 2 years



DA VINCI G2 GOLD
DA VINCI G2 ALTIN

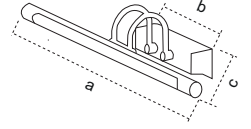

Code Kod	Power Güç (W)	Color Temp. Renk Sıcaklığı (K)	Luminous Flux Işık Akısı (lm)	Efficacy Etkinlik Faktörü (lm/W)	Dimensions Boyutlar (axbxc)	Package Weight Koli Ağırlığı (kg)	Pcs/Pack Koli Adedi	Price Fiyat
209107	6	3000	390	65	350x122x172	7,2	20	24,50\$
209106	9	3000	585	65	500x122x172	0,8	1	31,90\$

Aluminium Alüminyum Opal 3000/4000/6500K IP40 IK05 20.000h 2 years



DA VINCI G2 BLACK
DA VINCI G2 SİYAH

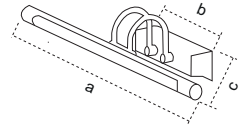

Code Kod	Power Güç (W)	Color Temp. Renk Sıcaklığı (K)	Luminous Flux Işık Akısı (lm)	Efficacy Etkinlik Faktörü (lm/W)	Dimensions Boyutlar (axbxc)	Package Weight Koli Ağırlığı (kg)	Pcs/Pack Koli Adedi	Price Fiyat
209105	6	3000	390	65	350x122x172	7,2	20	24,50\$
209104	9	3000	585	65	500x122x172	0,8	1	31,90\$

Aluminium Alüminyum Opal 3000/4000/6500K IP40 IK05 20.000h 2 years



DA VINCI G2 SILVER
DA VINCI G2 GÜMÜŞ

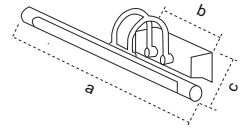

Code Kod	Power Güç (W)	Color Temp. Renk Sıcaklığı (K)	Luminous Flux Işık Akısı (lm)	Efficacy Etkinlik Faktörü (lm/W)	Dimensions Boyutlar (axbxc)	Package Weight Koli Ağırlığı (kg)	Pcs/Pack Koli Adedi	Price Fiyat
209109	6	3000	390	65	350x122x172	7,2	20	24,50\$
209108	9	3000	585	65	500x122x172	0,8	1	31,90\$

Aluminium Alüminyum Opal 3000/4000/6500K IP40 IK05 20.000h 2 years

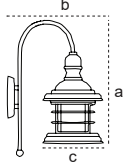

MAYA

Code Kod	Power Güç (W)	Color Temp. Renk Sıcaklığı (K)	Luminous Flux Işık Akısı (lm)	Efficacy Etkinlik Faktörü (lm/W)	Dimensions Boyutlar (axbxc)	Package Weight Koli Ağırlığı (kg)	Pcs/Pack Koli Adedi	Price Fiyat
208146	E27	-	-	-	480x340x200	-	1	48,70\$

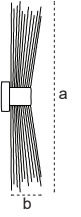

LORETA

Code Kod	Type Tip	Base Duy	Luminous Flux Işık Akısı (lm)	Efficacy Etkinlik Faktörü (lm/W)	Dimensions Boyutlar (axb)	Package Weight Koli Ağırlığı (kg)	Pcs/Pack Koli Adedi	Price Fiyat
208151	Black / Siyah	E14	-	-	450x200	-	-	26,00\$
208152	Antique / Eskitme	E14	-	-	450x200	-	-	26,00\$

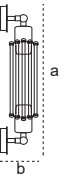

PIA

Code Kod	Type Tip	Base Duy	Luminous Flux Işık Akısı (lm)	Efficacy Etkinlik Faktörü (lm/W)	Dimensions Boyutlar (axbxc)	Package Weight Koli Ağırlığı (kg)	Pcs/Pack Koli Adedi	Price Fiyat
208148	Black / Siyah	E27	-	-	400x125	-	1	45,70\$
208149	Antique / Eskitme	E27	-	-	400x125	-	1	45,70\$
208150	Copper / Bakır	E27	-	-	400x125	-	1	45,70\$





OUTDOOR APPLIQUES DIŐ MEKAN APLİKLER

recta
art and light



FERRA

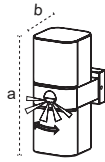

Code Kod	Power Güç (W)	Color Temp. Renk Sıcaklığı (K)	Luminous Flux Işık Akısı (lm)	Efficacy Etkinlik Faktörü (lm/W)	Dimensions Boyutlar (axb)	Package Weight Koli Ağırlığı (kg)	Pcs/Pack Koli Adedi	Price Fiyat
113599	20	4000	1600	80	244x100	7,4	10	47,95\$

- Plastic Body
Plastik Gövde
- IP65
- Sensor (9m)
Sensör (9m)
- Anthracite
Antrasit



TILVA

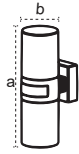

Code Kod	Power Güç (W)	Color Temp. Renk Sıcaklığı (K)	Luminous Flux Işık Akısı (lm)	Efficacy Etkinlik Faktörü (lm/W)	Dimensions Boyutlar (axb)	Package Weight Koli Ağırlığı (kg)	Pcs/Pack Koli Adedi	Price Fiyat
113596	20	4000	1600	123	250x80	10,8	20	47,95\$

- Plastic Body
Plastik Gövde
- IP65
- Sensor (12m)
Sensör (12m)
- Anthracite
Antrasit

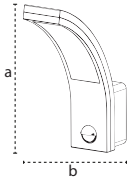

MOVA

Code Kod	Type Tıp	Power Güç (W)	Color Temp. Renk Sıcaklığı (K)	Luminous Flux Işık Akısı (lm)	Efficacy Etkinlik Faktörü (lm/W)	Dimensions Boyutlar (axb)	Package Weight Koli Ağırlığı (kg)	Pcs/Pack Koli Adedi	Price Fiyat
109228	White With Sensor Sensörlü Beyaz	10	4000	727	72	255x185	10	10	29,10\$

- Plastic Body
Plastik Gövde
- IP54
- Sensor
Sensör
- Anthracite
Antrasit

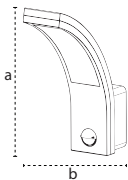

MOVA

Code Kod	Type Tıp	Power Güç (W)	Color Temp. Renk Sıcaklığı (K)	Luminous Flux Işık Akısı (lm)	Efficacy Etkinlik Faktörü (lm/W)	Dimensions Boyutlar (axb)	Package Weight Koli Ağırlığı (kg)	Pcs/Pack Koli Adedi	Price Fiyat
111603	Sensorless Anthracite Sensörsüz Antrasit	10	4000	727	72	255x185	10	10	21,65\$
110324	Anthracite With Sensors Sensörlü Antrasit	10	4000	727	72	255x185	10	10	29,10\$

- Plastic Body
Plastik Gövde
- IP54
- Sensor
Sensör

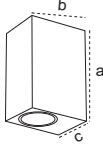
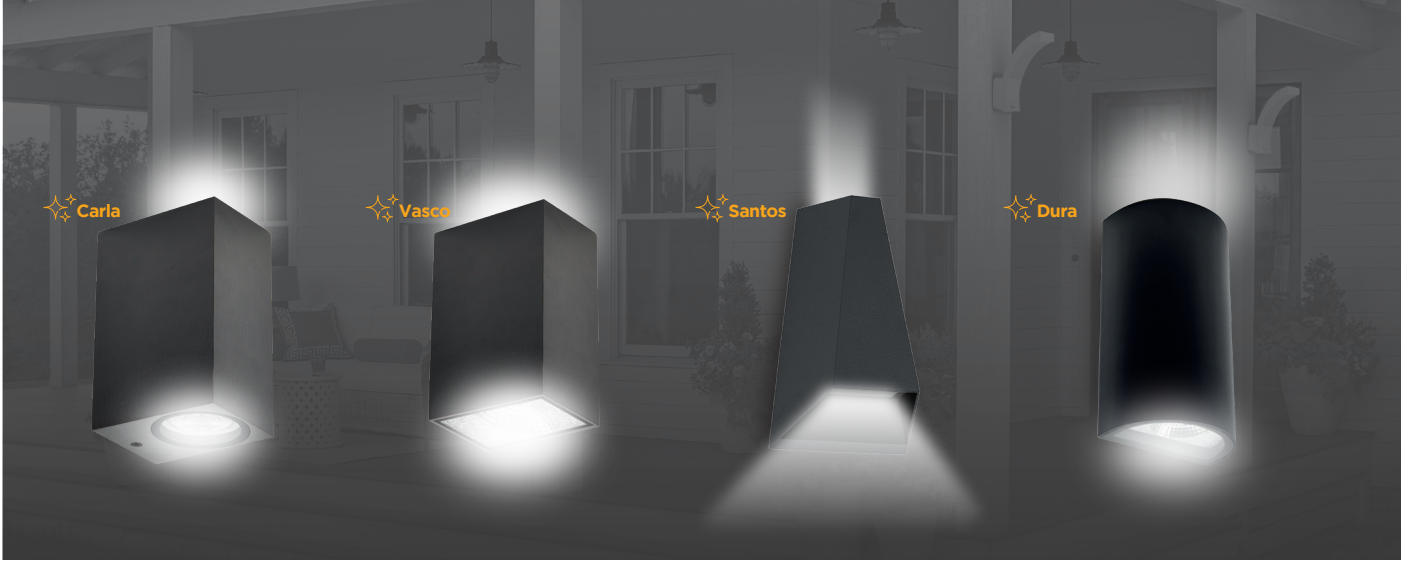

CARLA

Code Kod	Power Güç (W)	Color Temp. Renk Sıcaklığı (K)	Luminous Flux Işık Akısı (lm)	Efficacy Etkinlik Faktörü (lm/W)	Dimensions Boyutlar (a x b x c)	Package Weight Koli Ağırlığı (kg)	Pcs/Pack Koli Adedi	Price Fiyat
207106	2xGu10	-	-	-	150x93x70	-	1	39,50\$

- Aluminium Alüminyum
 - PMMA
 - IP44
 - 2 years
- RAL 9016

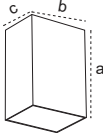

VASCO

Code Kod	Power Güç (W)	Color Temp. Renk Sıcaklığı (K)	Luminous Flux Işık Akısı (lm)	Efficacy Etkinlik Faktörü (lm/W)	Dimensions Boyutlar (a x b x c)	Package Weight Koli Ağırlığı (kg)	Pcs/Pack Koli Adedi	Price Fiyat
207108	2x4	3000	640	80	162x90x58	-	1	39,50\$

- Aluminium Alüminyum
 - PMMA
 - IP44
 - 50.000h
 - 2 years
- RAL 9016

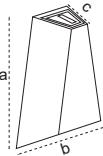

SANTOS

Code Kod	Power Güç (W)	Color Temp. Renk Sıcaklığı (K)	Luminous Flux Işık Akısı (lm)	Efficacy Etkinlik Faktörü (lm/W)	Dimensions Boyutlar (a x b x c)	Package Weight Koli Ağırlığı (kg)	Pcs/Pack Koli Adedi	Price Fiyat
207110	2x3	3000	480	80	176x111x62	-	1	39,90\$

- Aluminium Alüminyum
 - PMMA
 - IP44
 - 50.000h
 - 2 years
- RAL 9016

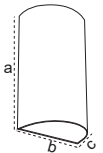

DURA

Code Kod	Power Güç (W)	Color Temp. Renk Sıcaklığı (K)	Luminous Flux Işık Akısı (lm)	Efficacy Etkinlik Faktörü (lm/W)	Dimensions Boyutlar (a x b x c)	Package Weight Koli Ağırlığı (kg)	Pcs/Pack Koli Adedi	Price Fiyat
208145	2x4	3000	480	80	160x90x58	-	1	39,50\$

- Aluminium Alüminyum
 - PMMA
 - IP44
 - 50.000h
 - 2 years
- RAL 9016

 **recta**

art and light

GARDEN LUMINAIRES
BAHÇE ARMATÜRLERİ



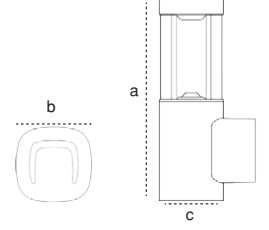

ALBERI

Code Kod	Power Güç (W)	Color Temp. Renk Sıcaklığı (K)	Luminous Flux Işık Akısı (lm)	Efficacy Etkinlik Faktörü (lm/W)	Dimensions Boyutlar (axbxc)	Package Weight Koli Ağırlığı (kg)	Pcs/Pack Koli Adedi	Price Fiyat
208562	6	3000	360	60	220x155x70	-	1	70,40\$

Aluminium Alüminyum IP54 CLASS I RAL7016

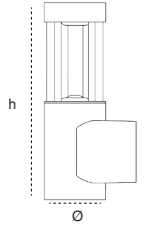

BELISE

Code Kod	Power Güç (W)	Color Temp. Renk Sıcaklığı (K)	Luminous Flux Işık Akısı (lm)	Efficacy Etkinlik Faktörü (lm/W)	Dimensions Boyutlar (Øxh)	Package Weight Koli Ağırlığı (kg)	Pcs/Pack Koli Adedi	Price Fiyat
208538	6	3000	360	60	70x220	-	1	70,40\$

Aluminium Alüminyum IP54 CLASS I RAL7016

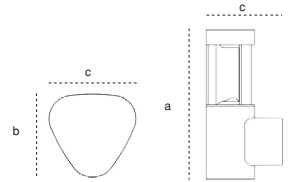

AYERS

Code Kod	Power Güç (W)	Color Temp. Renk Sıcaklığı (K)	Luminous Flux Işık Akısı (lm)	Efficacy Etkinlik Faktörü (lm/W)	Dimensions Boyutlar (axbxc)	Package Weight Koli Ağırlığı (kg)	Pcs/Pack Koli Adedi	Price Fiyat
208550	6	3000	360	60	220x70x75	-	1	88,70\$

Aluminium Alüminyum IP54 CLASS I RAL7016



ALBERİ

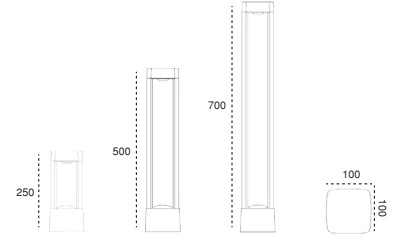

Code Kod	Power Güç (W)	Color Temp. Renk Sıcaklığı (K)	Luminous Flux Işık Akısı (lm)	Efficacy Etkinlik Faktörü (lm/W)	Dimensions Boyutlar (a x b x c)	Package Weight Koli Ağırlığı (kg)	Pcs/Pack Koli Adedi	Price Fiyat
208553	6	3000	420	70	250x100x100	-	1	56,10\$
208554	6	3000	420	70	500x100x100	-	1	65,30\$
208555	6	3000	420	70	700x100x100	-	1	70,40\$

Aluminium Alüminyum IP54 CLASS I RAL7016



BELİSE

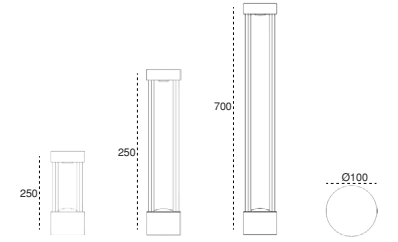

Code Kod	Power Güç (W)	Color Temp. Renk Sıcaklığı (K)	Luminous Flux Işık Akısı (lm)	Efficacy Etkinlik Faktörü (lm/W)	Dimensions Boyutlar (a x b x c)	Package Weight Koli Ağırlığı (kg)	Pcs/Pack Koli Adedi	Price Fiyat
208529	6	3000	420	70	250x100	-	1	56,10\$
208530	6	3000	420	70	500x100	-	1	65,30\$
208531	6	3000	420	70	700x100	-	1	70,40\$

Aluminium Alüminyum IP54 CLASS I RAL7016



AYERS

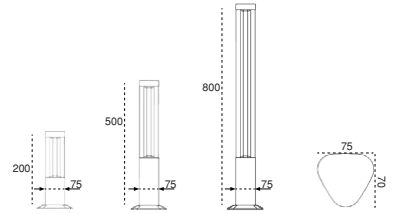

Code Kod	Power Güç (W)	Color Temp. Renk Sıcaklığı (K)	Luminous Flux Işık Akısı (lm)	Efficacy Etkinlik Faktörü (lm/W)	Dimensions Boyutlar (a x b x c)	Package Weight Koli Ağırlığı (kg)	Pcs/Pack Koli Adedi	Price Fiyat
208541	6	3000	420	70	200x75x70	-	1	71,40\$
208542	6	3000	420	70	500x75x70	-	1	80,60\$
208543	6	3000	420	70	800x75x70	-	1	88,70\$

Aluminium Alüminyum IP54 CLASS I RAL7016



YER GÖMME Ø80
RECESSED FLOOR Ø80

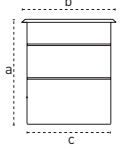

Code Kod	Power Güç (W)	Color Temp. Renk Sıcaklığı (K)	Luminous Flux Işık Akısı (lm)	Efficacy Etkinlik Faktörü (lm/W)	Dimensions Boyutlar (axbxc)	Package Weight Koli Ağırlığı (kg)	Pcs/Pack Koli Adedi	Price Fiyat
205998	3	4000	270	90	110x90x80	1,2	1	152,00\$

Aluminium Alüminyum Tempered Glass Temperli Cam 3000/4000/6500K IP67 IK10 30.000h 60°



YER GÖMME Ø100
RECESSED FLOOR Ø100

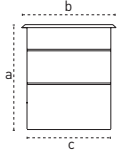

Code Kod	Power Güç (W)	Color Temp. Renk Sıcaklığı (K)	Luminous Flux Işık Akısı (lm)	Efficacy Etkinlik Faktörü (lm/W)	Dimensions Boyutlar (axbxc)	Package Weight Koli Ağırlığı (kg)	Pcs/Pack Koli Adedi	Price Fiyat
206001	6	4000	540	90	115x110x105	1,6	1	190,80\$

Aluminium Alüminyum Tempered Glass Temperli Cam 3000/4000/6500K IP67 IK10 30.000h 60°



YER GÖMME Ø150
RECESSED FLOOR Ø150

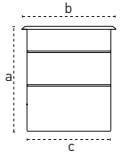

Code Kod	Power Güç (W)	Color Temp. Renk Sıcaklığı (K)	Luminous Flux Işık Akısı (lm)	Efficacy Etkinlik Faktörü (lm/W)	Dimensions Boyutlar (axbxc)	Package Weight Koli Ağırlığı (kg)	Pcs/Pack Koli Adedi	Price Fiyat
206004	9	4000	810	90	150x140x100	2,4	1	281,10\$
206007	18	4000	1620	90	150x140x100	2,4	1	281,10\$
206010	27	4000	2430	90	150x140x100	2,4	1	281,10\$

Aluminium Alüminyum Tempered Glass Temperli Cam 3000/4000/6500K IP67 IK10 30.000h 60°



OSCALED

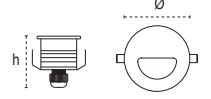

Code Kod	Power Güç (W)	Color Temp. Renk Sıcaklığı (K)	Luminous Flux Işık Akısı (lm)	Efficacy Etkinlik Faktörü (lm/W)	Dimensions Boyutlar (Øxh)	Cut Size Kesim Ölç. (mm)	Package Weight Koli Ağırlığı (kg)	Pcs/Pack Koli Adedi	Price Fiyat
206013	3	4000	300	100	59x60	60	0,3	1	104,60\$

Aluminium Alüminyum Opal Diffuser Opal Difüzör 3000/4000/6500K IP65 30.000h 160°

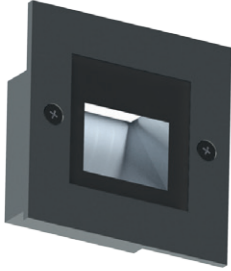

ESCALED

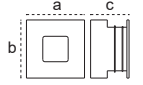

Code Kod	Power Güç (W)	Color Temp. Renk Sıcaklığı (K)	Luminous Flux Işık Akısı (lm)	Efficacy Etkinlik Faktörü (lm/W)	Dimensions Boyutlar (axbxc)	Cut Size Kesim Ölç. (mm)	Package Weight Koli Ağırlığı (kg)	Pcs/Pack Koli Adedi	Price Fiyat
205989	3	4000	300	100	85x45	45	0,3	1	110,70\$

Aluminium Alüminyum Opal Diffuser Opal Difüzör 3000/4000/6500K IP65 30.000h Asymmetric Asimetrik



SANTA

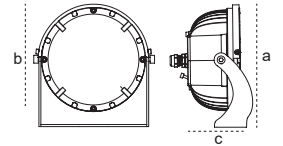

Code Kod	Power Güç (W)	Color Temp. Renk Sıcaklığı (K)	Luminous Flux Işık Akısı (lm)	Efficacy Etkinlik Faktörü (lm/W)	Dimensions Boyutlar (axbxc)	Package Weight Koli Ağırlığı (kg)	Pcs/Pack Koli Adedi	Price Fiyat
206822	15	4000	2100	140	283x185x101	1,6	1	142,10\$
206825	25	4000	3500	140	283x185x101	1,6	1	156,90\$
206828	30	4000	4200	140	283x185x101	1,6	1	171,90\$

Aluminium Alüminyum Tempered Glass Temperli Cam 3000/4000/6500K IP65 IK08 50.000h 30°/60°/90°/Symmetric Simetrik RAL 9005 RAL 9006 RAL 7016



DMX
DMX WALLWASHER
LED BAR



Light up individually, in groups, or all together, whenever you want, for as long as you want
Tek tek, gruplar halinde veya hepsi birlikte istediğiniz zaman istediğiniz süre aydınlatın.

Prices are project based. Please ask for the price.
Projelere özel fiyatlandırılır. Fiyat sorunuz.

Mechanical Specifications Mekanik Özellikler

Body Gövde	Aluminium Alüminyum
Diffuser Difüzör	UV Polycarbonate UV Polikarbon
Cover Kapak	ABS
Mounting Bracket Montaj Braket	Aluminium Extrusion Alüminyum Ekstrüzyon
Equipment Donanım	Stainless Steel Paslanmaz Çelik

Optical Specifications Optik Özellikler

Light Source Işık Kaynağı	48pcs/m 3 in 1 Chip RGB LEDs
LED Range LED Aralığı	21mm
Color Range Renk Aralığı	16 Million Milyon
Beam Angle Işık Açısı	160°

Electrical Specifications Elektriksel Özellikler

Input Voltage Giriş Gerilimi	24V DC
Power Güç	12W
Connector Konnektör	IP67 4 pin

Control and Programming Kontrol ve Programlama

Pixel Pitch Piksel Aralığı	8 Pixel/m
Color Resolution Renk Çözünürlüğü	3x14-bit
Addressing Adresleme	Manual adress / Manuel adresleme
DMX Compatibility DMX Uyumluluğu	USITT DMX512 - 1990

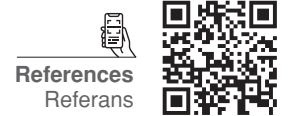

References
Referans

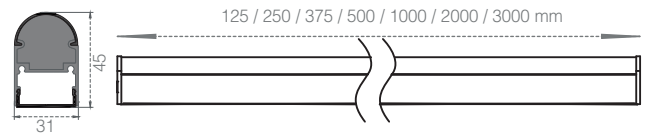

SYSTEM / SİSTEM

Online System Online Sistem

- **170 pixels per port (21m)**
Port başı 170 piksel (21m)
- **One online control card has 8 ports in total.**
Bir online kontrol kartında toplam 8 port bulunur.
- **It is controlled by computer.**
Bilgisayar tarafından kontrol edilir.
- **Remote connection feature is available.**
Uzaktan bağlantı özelliği mevcuttur.
- **The data distance between the product and the control card should not exceed 70 meters.**
Ürün ile kontrol kartı arasındaki data mesafesi 70 metreyi geçmemelidir.

Offline System Offline Sistem

- **512 pixels (64 meter) per port is recommended 40 meters.**
Port başı 512 piksel (64 metre) önerilen 40metredir.
- **There are 8 ports in total on one offline control card.**
Bir adet offline kontrol kartında toplamda 8 port bulunmaktadır.
- **It is controlled via SD card.**
SD kart üzerinden kontrol edilmektedir.
- **There are 22 demo software in the controller.**
Kontrol cihazı içerisinde 22 adet demo yazılım bulunmaktadır.
- **30 different software can be added in the SD card.**
SD kartın içerisinde 30 farklı yazılım eklenebilmektedir.
- **The software is changed via the controller**
Yazılımlar kontrol cihazı üzerinden değiştirilmektedir
- **The data distance between the product and the control card should not exceed 70 meters.**
Ürün ile kontrol kartı arasındaki data mesafesi 70 metreyi geçmemelidir

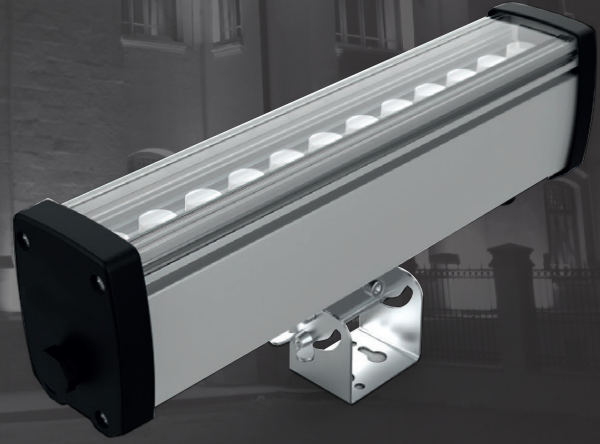

Prices are project based. Please ask for the price.
Projelere özel fiyatlandırılır. Fiyat sorunuz.

Mechanical Specifications Mekanik Özellikler

Body Gövde	Aluminium Alüminyum
Diffuser Difüzör	UV Polycarbonate UV Polikarbon
Cover Kapak	ABS
Mounting Bracket Montaj Braket	Aluminium Extrusion Alüminyum Ekstrüzyon
Equipment Donanım	Stainless Steel Paslanmaz Çelik

Optical Specifications Optik Özellikler

Light Source Işık Kaynağı	-
LED Chip LED Çip	3535 RGBW Full Color High Power LED
LED Range LED Aralığı	50mm
Color Range Renk Aralığı	16 Million Milyon
Color Renk	RGBW
Beam Angle Işık Açısı	10°-15°-30°-45°-60°-90°-120°

Electrical Specifications Elektriksel Özellikler

Input Voltage Giriş Gerilimi	220Vac
Power Güç	12W
Connector Konnektör	IP67 4 pin

Control and Programming Kontrol ve Programlama

Pixel Pitch Piksel Aralığı	1 Pixel
Color Resolution Renk Çözünürlüğü	4x14-bit
Addressing Adresleme	Manuel adress / Manuel adresleme
DMX Compatibility DMX Uyumluluğu	USITT DMX512 - 1990

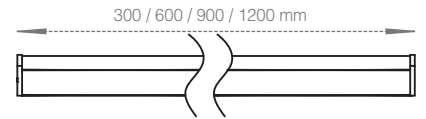
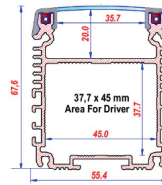

SYSTEM / SİSTEM

Online System Online Sistem

- **170 pixels per port (21m)**
Port başı 170 piksel (21m)
- **One online control card has 8 ports in total.**
Bir online kontrol kartında toplam 8 port bulunur.
- **It is controlled by computer.**
Bilgisayar tarafından kontrol edilir.
- **Remote connection feature is available.**
Uzaktan bağlantı özelliği mevcuttur.
- **The data distance between the product and the control card should not exceed 70 meters.**
Ürün ile kontrol kartı arasındaki data mesafesi 70 metreyi geçmemelidir.

Offline System Offline Sistem

- **512 pixels (64 meter) per port is recommended 40 meters.**
Port başı 512 piksel (64 metre) önerilen 40metredir.
- **There are 8 ports in total on one offline control card.**
Bir adet offline kontrol kartında toplamda 8 port bulunmaktadır.
- **It is controlled via SD card.**
SD kart üzerinden kontrol edilmektedir.
- **There are 22 demo software in the controller.**
Kontrol cihazı içerisinde 22 adet demo yazılım bulunmaktadır.
- **30 different software can be added in the SD card.**
SD kartın içerisinde 30 farklı yazılım eklenebilmektedir.
- **The software is changed via the controller**
Yazılımlar kontrol cihazı üzerinden değiştirilmektedir
- **The data distance between the product and the control card should not exceed 70 meters.**
Ürün ile kontrol kartı arasındaki data mesafesi 70 metreyi geçmemelidir

Surface Mounted V Type
Sıva Üstü V Tipi

Surface Mounted U Type
Sıva Üstü U Tipi

Recessed Mounted
Sıva Altı

Aluminium
Body

IP
40

50.000h

12V DC

24V DC

SMD
LED

The length can be adjusted intervals of 10cm and up to 300cm
10cm'den başlayıp 10cm aralıklı 300cm uzunluğa kadar üretilebilir.

SURFACE MOUNTED V TYPE 24V DC SIVA ÜSTÜ V TİPİ 24V DC

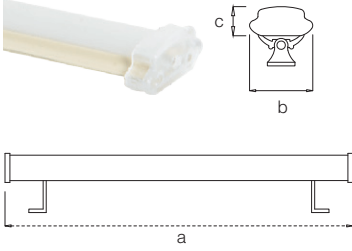

Code Kod	Power Güç (W)	Color Temp. Renk Sıcaklığı (K)	Luminous Flux Işık Akısı (lm)	Efficacy Etkinlik Faktörü (lm/W)	Dimensions Boyutlar (axbxc)	Package Weight Koli Ağırlığı (kg)	Pcs/Pack Koli Adedi	Price Fiyat
206107	15	3000	1425	95	1010x30x14	2,65	15	16,30\$
206108	15	4000	1455	97	1010x30x14	2,65	15	16,30\$
206109	15	6500	1500	100	1010x30x14	2,65	15	16,30\$
206110	6	Kırmızı/Red	-	-	1010x30x14	2,65	15	21,70\$
206111	6	Yeşil/Green	-	-	1010x30x14	2,65	15	21,70\$
206112	6	Mavi/Blue	-	-	1010x30x14	2,65	15	21,70\$
206113	15	Amber	-	-	1010x30x14	2,65	15	21,70\$

SURFACE MOUNTED U TYPE 24V DC SIVA ÜSTÜ U TİPİ 24V DC

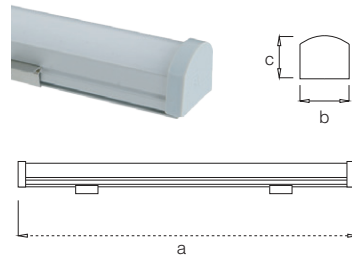

Code Kod	Power Güç (W)	Color Temp. Renk Sıcaklığı (K)	Luminous Flux Işık Akısı (lm)	Efficacy Etkinlik Faktörü (lm/W)	Dimensions Boyutlar (axbxc)	Package Weight Koli Ağırlığı (kg)	Pcs/Pack Koli Adedi	Price Fiyat
206121	15	3000	1425	95	1010x21x20	2,35	15	19,10\$
206122	15	4000	1455	97	1010x21x20	2,35	15	19,10\$
206123	15	6500	1500	100	1010x21x20	2,35	15	19,10\$
206124	6	Kırmızı/Red	-	-	1010x21x20	2,35	15	24,50\$
206125	6	Yeşil/Green	-	-	1010x21x20	2,35	15	24,50\$
206126	6	Mavi/Blue	-	-	1010x21x20	2,35	15	24,50\$
206127	15	Amber	-	-	1010x21x20	2,35	15	24,50\$

RECESSED MOUNTED 24V DC SIVA ALTI 24V DC

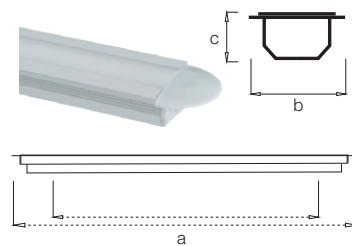

Code Kod	Power Güç (W)	Color Temp. Renk Sıcaklığı (K)	Luminous Flux Işık Akısı (lm)	Efficacy Etkinlik Faktörü (lm/W)	Dimensions Boyutlar (axbxc)	Package Weight Koli Ağırlığı (kg)	Pcs/Pack Koli Adedi	Price Fiyat
206135	15	3000	1425	95	1010x24x12	2,65	15	19,10\$
206136	15	4000	1455	97	1010x24x12	2,65	15	19,10\$
206137	15	6500	1500	100	1010x24x12	2,65	15	19,10\$
206138	6	Kırmızı/Red	-	-	1010x24x12	2,65	15	24,50\$
206139	6	Yeşil/Green	-	-	1010x24x12	2,65	15	24,50\$
206140	6	Mavi/Blue	-	-	1010x24x12	2,65	15	24,50\$
206141	15	Amber	-	-	1010x24x12	2,65	15	24,50\$

Surface Mounted V Type
Sıva Üstü V Tipi

Surface Mounted U Type
Sıva Üstü U Tipi

Recessed Mounted
Sıva Altı

Aluminium
Body

IP
67

50.000h

12V DC

24V DC

SMD
LED

The length can be adjusted intervals of 10cm and up to 300cm
10cm'den başlayıp 10cm aralıklı 300cm uzunluğa kadar üretilebilir.

SURFACE MOUNTED V TYPE 24V DC SIVA ÜSTÜ V TİPİ 24V DC

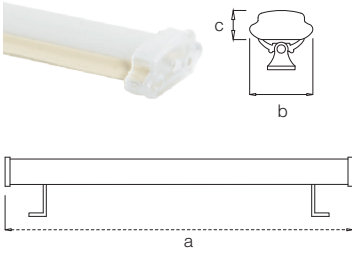

Code Kod	Power Güç (W)	Color Temp. Renk Sıcaklığı (K)	Luminous Flux Işık Akısı (lm)	Efficacy Etkinlik Faktörü (lm/W)	Dimensions Boyutlar (axbxc)	Package Weight Koli Ağırlığı (kg)	Pcs/Pack Koli Adedi	Price Fiyat
206114	15	3000	1425	95	1010x30x14	2,95	15	24,50\$
206115	15	4000	1455	97	1010x30x14	2,95	15	24,50\$
206116	15	6500	1500	100	1010x30x14	2,95	15	24,50\$
206117	6	Kırmızı/Red	-	-	1010x30x14	2,95	15	29,90\$
206118	6	Yeşil/Green	-	-	1010x30x14	2,95	15	29,90\$
206119	6	Mavi/Blue	-	-	1010x30x14	2,95	15	29,90\$
206120	15	Amber	-	-	1010x30x14	2,95	15	29,90\$

SURFACE MOUNTED U TYPE 24V DC SIVA ÜSTÜ U TİPİ 24V DC

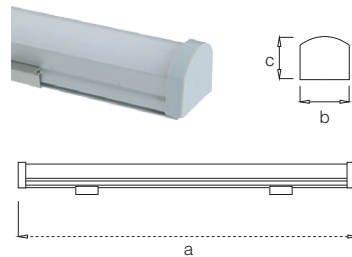

Code Kod	Power Güç (W)	Color Temp. Renk Sıcaklığı (K)	Luminous Flux Işık Akısı (lm)	Efficacy Etkinlik Faktörü (lm/W)	Dimensions Boyutlar (axbxc)	Package Weight Koli Ağırlığı (kg)	Pcs/Pack Koli Adedi	Price Fiyat
206128	15	3000	1425	95	1010x21x20	2,55	15	27,20\$
206129	15	4000	1455	97	1010x21x20	2,55	15	27,20\$
206130	15	6500	1500	100	1010x21x20	2,55	15	27,20\$
206131	6	Kırmızı/Red	-	-	1010x21x20	2,55	15	32,70\$
206132	6	Yeşil/Green	-	-	1010x21x20	2,55	15	32,70\$
206133	6	Mavi/Blue	-	-	1010x21x20	2,55	15	32,70\$
206134	15	Amber	-	-	1010x21x20	2,55	15	32,70\$

RECESSED MOUNTED 24V DC SIVA ALTI 24V DC

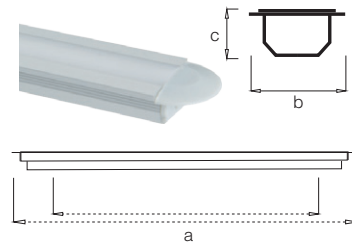

Code Kod	Power Güç (W)	Color Temp. Renk Sıcaklığı (K)	Luminous Flux Işık Akısı (lm)	Efficacy Etkinlik Faktörü (lm/W)	Dimensions Boyutlar (axbxc)	Package Weight Koli Ağırlığı (kg)	Pcs/Pack Koli Adedi	Price Fiyat
206142	15	3000	1425	95	1010x24x12	2,65	15	27,20\$
206143	15	4000	1455	97	1010x24x12	2,65	15	27,20\$
206144	15	6500	1500	100	1010x24x12	2,65	15	27,20\$
206145	6	Kırmızı/Red	-	-	1010x24x12	2,65	15	32,70\$
206146	6	Yeşil/Green	-	-	1010x24x12	2,65	15	32,70\$
206147	6	Mavi/Blue	-	-	1010x24x12	2,65	15	32,70\$
206148	15	Amber	-	-	1010x24x12	2,65	15	32,70\$





